

DEPARTMENT OF HEALTH & HUMAN SERVICES
Centers for Medicare & Medicaid Services
7500 Security Boulevard, Mail Stop S2-26-12
Baltimore, Maryland 21244-1850



March 21, 2024

Kristin Sousa
Deputy Secretary and Medicaid Director
Rhode Island Executive Office of Health and Human Services
3 West Rd, Virks Building
Cranston, RI 02920

Dear Director Sousa:

The Centers for Medicare & Medicaid Services (CMS) is approving an amendment to Rhode Island's section 1115(a) demonstration entitled, "Rhode Island Comprehensive Demonstration" (Project Number 11-W-00242/1), in accordance with section 1115(a) of the Social Security Act (the Act). The approved requests under this amendment were submitted with the state's demonstration extension application on December 22, 2022, and an amendment to the pending extension application submitted on September 12, 2023. CMS approved a temporary extension of the state's section 1115 demonstration on September 12, 2023, to allow the state and CMS to continue negotiations over the state's demonstration extension application. With this approval, the demonstration amendment will become effective as of the date of this approval through December 31, 2024.

CMS has determined that Rhode Island's demonstration amendment is likely to assist in promoting the objectives of the Medicaid statute by increasing access to high-quality medical assistance coverage for certain low-income individuals. Approval of this amendment allows the state to (1) provide 1915(c)-like personal care services (PCS) in acute care hospital settings; (2) expand eligibility for home and community-based services (HCBS) waiver-like services for adults with disabilities at risk for long term care (LTC); (3) update the pregnant individuals expenditure authority populations to reference 12 months rather than 60 days of postpartum coverage to align with the Medicaid and Children's Health Insurance Program (CHIP) postpartum State Plan Amendments (SPAs) that extended postpartum coverage from 60 days to 12 months; (4) add remote supports and monitoring to available HCBS; (5) modify the provider education requirements for home stabilization services; and (6) provide long-term authority for previous COVID-19 Public Health Emergency (PHE) Attachment K flexibilities, such as allowing parents and non-spouse relatives of adult participants to provide self-directed HCBS services. These authorities are described in detail below.

CMS's approval of this section 1115(a) demonstration, as amended, is subject to the limitations specified in the attached waiver and expenditure authorities, special terms and conditions

(STCs), and any supplemental attachments defining the nature, character, and extent of federal involvement in this project. The state may deviate from the Medicaid state plan requirements only to the extent those requirements have been specifically listed as waived or not applicable to expenditures under the demonstration.

Extent and Scope of Demonstration Amendment

(1) Personal Care Services in Acute Care Hospital Settings

The Rhode Island Comprehensive Demonstration provides HCBS benefits to a variety of populations using currently existing HCBS expenditure authorities. The Coronavirus Aid, Relief, and Economic Security (CARES) Act, Pub. L. No. 116-136, Div. A, title III, subtitle D, section 3715, 134 Stat. 424, (March 27, 2020) (codified at 42 U.S.C. section 1396(a)(h)), states that Medicaid HCBS can be provided in an acute care hospital if they are identified in an individual's service plan, are provided to meet individual needs that are unmet by hospital services, do not substitute for services that the hospital is obligated to provide, and are designed to ensure smooth transitions between acute care and HCBS settings and preserve the individual's functional abilities. As permitted by section 3715 of the CARES Act, CMS is updating the definition of personal care services in Attachment B of the STCs, entitled "Core, Preventive, and Therapeutic HCBS Definitions" to include references to personal care services being allowed in acute care hospital settings if the CARES Act requirements above are met. Allowing personal care service to be provided in an acute care hospital is likely to improve beneficiaries' immediate experience of short-term hospital stays, improve transitions of care back to the community, and reduce the risk that hospital stays will lead to institutionalization.

(2) Expand Eligibility for HCBS Waiver-Like Services for Adults with Disabilities at Risk for LTC

The amendment expands eligibility for HCBS-like waiver like services for a demonstration expenditure authority population, Adults at Risk for LTC (Budget Population 15). The amendment increases the income level from at or below 300 percent to at or below 400 percent of the Supplemental Security Income (SSI) Federal Benefit Rate (FBR). This will expand the availability of HCBS waiver-like services to additional low-income beneficiaries to prevent the need for long-term institutional care.

(3) Updates to Pregnant Individuals Expenditure Authority Populations to Reference 12 Months Postpartum Coverage

CMS is approving updates to the two 1115 expenditure authority pregnant individual populations (Budget Populations 6a and 6b) to reference 12 months rather than 60 days of postpartum coverage. This aligns with CMS's April 19, 2023, approval of a Medicaid SPA and CMS's April 23, 2023, approval of the Rhode Island CHIP SPA which provided 12-months of postpartum coverage. As part of the amendment, CMS is also updating the eligibility Federal Poverty Levels (FPLs) in the STCs to reflect the modified adjusted gross income conversion.

(4) Addition of Remote Supports and Monitoring to Available HCBS

The amendment provides updates to the state’s approved Attachment B, “Core, Preventive, and Therapeutic HCBS Definitions” to include remote supports and monitoring as a HCBS. Beneficiaries will be given information to support their decision-making regarding whether to use remote supports and monitoring. Services will be detailed in the individual’s service plan based on the individual’s preferences and a risk assessment to determine if the service will meet the individual’s support needs. Any monitoring will only be deployed with the express agreement of the individual.

(5) Change in the Provider Education Requirements for Home Stabilization Services

The amendment also provides adjustments to the provider education requirements for home stabilization services to increase the availability of home stabilization services. Home stabilization services include home tenancy services and home find services. The state reported that many individuals with lived experience of housing insecurity are particularly well-suited to deliver this service, but they may lack the formal education currently required. Therefore, the STCs have been modified to allow home stabilization providers to possess at least a high school diploma or General Educational Development (GED) Test with one year of lived or professional experience.

(6) Long-Term Approval of COVID-19 Attachment K HCBS Flexibilities

During the COVID-19 PHE, the traditional provider workforce was diminished leading to inadequate capacity to provide medically necessary services such as supporting activities of daily living. On November 8, 2023, CMS approved a temporary extension of all the currently approved Attachment K HCBS flexibilities, compliant with the maintenance of effort provisions of Section 9817 of the American Rescue Plan Act of 2021, Pub. L. No. 117-2 (March 11, 2021). Approval of the amendment transitions the short-term authority for the Attachment K flexibilities to the existing section 1115(a)(2) HCBS authorities. Specifically, the amendment provides Rhode Island with long-term authority under this demonstration project to allow person-centered planning meetings, evaluations, and functional assessments to take place virtually rather than in person. The amendment also provides long-term authority for parents and non-spouse relatives of adult participants to work as paid providers of HCBS self-directed services and supports. Finally, the amendment also provides long-term authority for electronic signatures for person-centered service plans when meetings are held virtually.

Requests Not Being Approved at this Time

CMS and Rhode Island are continuing discussions on the remaining components of the state’s December 22, 2022, extension application, to include new policy initiatives and technical revisions, which are described below.

As part of the demonstration extension, Rhode Island requested expenditure authority to provide pre-release supports and Medicaid coverage for incarcerated Medicaid-enrolled adults and youth 30 days prior to returning to the community. CMS is supportive of increasing pre-release

services for justice-involved populations in order to assist in making successful transitions from the carceral system back into the community and will continue to work with the state on this initiative.

The state also requested expenditure authority for health-related social needs services. Specifically, the state requested to expand eligibility for home stabilization services and one-time transitional supports to the home stabilization benefit. The state also requested authority for a restorative and recuperative care (medical respite) pilot program to support homeless individuals in need of a recuperative care setting while recovering from or preparing for medical treatment. CMS is supportive of certain health-related social needs services and will continue to work with the state on this initiative as part of the demonstration extension.

The state's extension request included other modifications to demonstration such as expanding demonstration benefits to a broader population, covering adult dental services through managed care rather than fee-for-service, modifying the level of care criteria in Attachment D, and clarifying the distinction between Family/ Youth Support Partners and Peer Recovery Specialists benefits. The state also requested a variety of technical updates such as removing references to outdated programs or authorities. CMS continues to work with the state on these requests.

Budget Neutrality

Under section 1115(a) demonstrations, states can test innovative approaches to operating their Medicaid programs if CMS determines that the demonstration is likely to assist in promoting the objectives of the Medicaid statute. CMS has long required, as a condition of demonstration approval, that demonstrations be “budget neutral,” meaning the federal costs of the state's Medicaid program with the demonstration cannot exceed what the federal government's Medicaid costs in that state likely would have been without the demonstration. In requiring demonstrations to be budget neutral, CMS is constantly striving to achieve a balance between its interest in preserving the fiscal integrity of the Medicaid program and its interest in facilitating state innovation through section 1115 approvals. In practice, budget neutrality generally means that the total computable (i.e., both state and federal) costs for approved demonstration expenditures are limited to a certain amount for the demonstration approval period. This limit is called the budget neutrality expenditure limit and is based on a projection of the Medicaid expenditures that could have occurred absent the demonstration (the “without waiver” (WOW) costs).

CMS and states have generally been applying an approach to calculating budget neutrality that CMS described in a 2018 State Medicaid Director Letter.¹ CMS is revising the approach to adjusting the budget neutrality calculation in the middle of a demonstration approval period. Historically, CMS has limited its review of state requests for “mid-course” budget neutrality adjustments to situations that necessitate a corrective action plan, in which projected expenditure data indicate a state is likely to exceed its budget neutrality expenditure limit. CMS has updated its approach to mid-course corrections in this demonstration approval to provide flexibility and

¹ August 22, 2018. SMD#18-009 Re: Budget Neutrality Policies for Section 1115(a) Demonstration Projects. <https://www.medicaid.gov/sites/default/files/federal-policy-guidance/downloads/smd18009.pdf>

stability for the state over the life of a demonstration. This update identifies, in the STCs, a list of circumstances under which a state’s baseline may be adjusted based on actual expenditure data to accommodate circumstances that are either out of the state’s control (e.g., expensive new drugs that the state is required to cover enter the market); and/or the effect is not a condition or consequence of the demonstration (e.g., unexpected costs due to a public health emergency); and/or the new expenditure (while not a new demonstration-covered service or population that would require the state to propose an amendment to the demonstration) is likely to further strengthen access to care (e.g., a legislated increase in provider rates). CMS also explains in the STCs what data and other information the state should submit to support a potentially approvable request for an adjustment. CMS considers this a more rational, transparent, and standardized approach to permitting budget neutrality modifications during the course of a demonstration.

Although the demonstration amendment increases the income limit for a with waiver (WW)-only expenditure authority population, adds remote supports and monitoring as an available HCBS, and makes other adjustments to the delivery of HCBS, these modifications are projected to be budget neutral to the federal government. The state will be held to the budget neutrality monitoring and reporting requirements in accordance with the STCs.

Monitoring and Evaluation

The state is required to conduct systematic monitoring and robust evaluation of the demonstration amendment in accordance with the STCs. The state is required to incorporate this amendment into its evaluation activities to support a comprehensive assessment of whether the initiatives in this demonstration are effective in producing the desired outcomes for beneficiaries and the state’s overall Medicaid program. Evaluation of the PCS in acute care hospital settings component of the amendment should examine the impacts on care transitions and rates of institutionalization. The state must also evaluate the impact of the other HCBS amendment components on spending, utilization, quality of care, and rates of institutionalization, as applicable. Additionally, the state’s monitoring and evaluation efforts must facilitate understanding the extent to which the amendment might support reducing existing disparities in access to and quality of care and health outcomes.

Consideration of Public Comments

Extension Application Public Notice

For the state’s extension application, CMS conducted a federal comment period from January 6, 2023, through February 5, 2023. There were 13 public comments received during the federal comment period, ten of which were in support of the application and three of which were not relevant. Seven of the comments pertained to the elements of the extension request that CMS is approving as part of this amendment. Three of the comments pertained to elements of the extension request that continue to be under review. Comments were received from provider organizations, advocacy organizations, research organizations, and one individual. One commenter wrote to express support for the expansion of home stabilization services providers; the changes to HCBS, specifically the telephonic assessments; remote supports and monitoring; and parents as service providers. A total of four commenters supported updating the

references to the pregnant individual expenditure authorities to include 12-months of postpartum coverage. Other commenters advocated for modifying the educational requirements to increase the number of home stabilization providers.

Amendment Application Public Notice

For the state's amendment application, CMS conducted a federal public notice and comment period from September 25, 2023, through October 25, 2023, and received several comments unrelated to the proposal and one comment in support of the proposal. The individual commenter stated that PCS in acute care hospital settings will improve the ability of individuals with intellectual and developmental disabilities (I/DD) to bilaterally communicate with hospital staff, thus improving the accessibility of care and strengthening the treatment plan.

After careful review of the public comments submitted during the federal comment period and the information received from the state public comment period, CMS has concluded that the demonstration amendment is likely to advance the objectives of Medicaid.

Other Information

CMS's approval of this amendment is conditioned on compliance with the enclosed expenditure authorities, waiver authorities, and the STCs defining the nature, character, and extent of anticipated federal involvement in the project. The award is subject to your written acknowledgement of the award and acceptance of the STCs within 30 days of the date of this letter.

Your project officer for this demonstration is Kathleen O'Malley. She is available to answer any questions concerning your amendment. Her contact information is as follows:

Centers for Medicare & Medicaid Services
Center for Medicaid and CHIP Services
Mail Stop: S2-25-26
7500 Security Boulevard
Baltimore, MD 21244-1850
Email: Kathleen.OMalley@cms.hhs.gov
Phone: (410) 786-8987

If you have questions regarding this approval, please contact Jacey Cooper, Director, State Demonstrations Group, Center for Medicaid and CHIP Services, at (410) 786-9686.

Sincerely,

A handwritten signature in black ink, appearing to be 'D. Tsai', with a long horizontal stroke extending to the right.

Daniel Tsai
Deputy Administrator and Director

Enclosure

cc: Joyce Butterworth, State Monitoring Lead, CMS Medicaid & CHIP Operations Group

CENTERS FOR MEDICARE & MEDICAID SERVICES

WAIVER LIST

NUMBER: 11-W-00242/1

TITLE: Rhode Island Comprehensive Demonstration

AWARDEE: Rhode Island Executive Office of Health and Human Services

Title XIX Waivers

All requirements of the Medicaid program expressed in law, regulation and policy statement, not expressly waived in this list, shall apply to the demonstration project beginning as of January 1, 2019, through December 31, 2024. In addition, these waivers may only be implemented consistent with the approved Special Terms and Conditions (STCs).

Under the authority of section 1115(a)(1) of the Social Security Act (the Act), the following waivers of State plan requirements contained in section 1902 of the Act are granted in order to enable Rhode Island to carry out the Rhode Island Comprehensive section 1115 demonstration.

1. Amount, Duration, and Scope **Section 1902(a)(10)(B)**

To enable Rhode Island to vary the amount, duration and scope of services offered to individuals, regardless of eligibility category, by providing additional services to individuals who are enrollees in certain managed care arrangements.

2. Reasonable Promptness **Section 1902(a)(8)**

To enable the state to impose waiting periods for home and community-based services (HCBS) waiver-like long term care services.

3. Comparability of Eligibility Standards **Section 1902(a)(17)**

To permit the state to apply standards different from those specified in the Medicaid state plan for determining eligibility, including, but not limited to, different income counting methods.

4. Freedom of Choice

Section 1902(a)(23)(A)

To enable the state to restrict freedom of choice of provider for individuals in the demonstration. No waiver of freedom of choice is authorized for family planning providers.

5. Retroactive Eligibility

Section 1902(a)(34)

To enable the state to exclude individuals in the demonstration from receiving coverage for up to 3 months prior to the date that an application for assistance is made.

The waiver of retroactive eligibility does not apply to individuals under section 1902(l)(4)(A) of the Act or the ABD population.

6. Payment Review

Section 1902(a)(37)(B)

To the extent that the state would otherwise need to perform prepayment review for expenditures under programs for self-directed care by individual beneficiaries.

7. Proper and Efficient Administration

Section 1902(a)(4)

To permit the State to enter into contracts with a single Prepaid Ambulatory Health Plan (PAHP) for the delivery of dental services under the RIteSmiles Program without regard to the choice requirements of 42 C.F.R. § 438.52.

CENTERS FOR MEDICARE & MEDICAID SERVICES

EXPENDITURE AUTHORITY

NUMBER: 11-W-00242/1

TITLE: Rhode Island Comprehensive Demonstration

AWARDEE: Rhode Island Executive Office of Health and Human Services

Under the authority of section 1115(a)(2) of the Social Security Act (the Act), expenditures made by Rhode Island for items identified below, which are not otherwise included as matchable expenditures under section 1903 of the Act shall, for the period of this demonstration beginning January 1, 2019, through December 31, 2024, unless otherwise specified, be regarded as expenditures under the state's title XIX plan.

The following expenditure authorities may only be implemented consistent with the approved Special Terms and Conditions (STCs) and shall enable Rhode Island (the state) to operate its section 1115 Medicaid demonstration.

1. Expenditures Related to Eligibility Expansion

Expenditures to provide medical assistance coverage to the following demonstration populations, who meet applicable citizenship and identity requirements that are not covered under the Medicaid state plan and are enrolled in the Rhode Island Comprehensive demonstration.

[Note: Budget populations 1, 2, 4, and 22, which are described in the demonstration's special terms and conditions and are affected by the demonstration, are covered under the Medicaid state plan. Demonstration populations 11 – 13 (related to 217-like groups) are described in expenditure authority 2 below, and demonstration population 7 is described in CHIP expenditure authority 1 below.]

Budget Population 3 [RIte Care]:

Expenditures for pregnant individuals with incomes up to 190 percent of the federal poverty level (FPL) and children whose family incomes are up to 261 percent of the FPL who are not otherwise eligible under the approved Medicaid state plan.

Budget Population 5 [EFP]: Expenditures for family planning services under the Extended Family Planning program, for women individuals of childbearing age

whose family income is at or below 253 percent of the FPL who lose Medicaid or CHIP Targeted Low Income Pregnant Individuals eligibility at the conclusion of their 12-month postpartum period. Continued program eligibility for these women individuals will be determined by the twelfth month after their enrollment in the program.

Budget Population 6a [Pregnant Expansion]: Individuals who, at the time of initial application: (a) are uninsured pregnant individuals; (b) have no other coverage; (c) have net family incomes between 190 and 253 percent of the FPL; (d) receive benefits only by virtue of the Comprehensive demonstration; (e) meet the citizenship and identity requirements specified in the Deficit Reduction Act of 2005; and f) are covered using title XIX funds if title XXI funds are exhausted. Expenditures for Medicaid state plan benefits to extend the postpartum eligibility period from the end of the month in which the 60th postpartum day occurs to the end of the 12th month following the end of the pregnancy. This authority is only needed if the XXI funds are exhausted.

Budget Population 6b [Pregnant Expansion]: Individuals who, at the time of initial application: (a) are pregnant individuals; (b) have other coverage; (c) have net family incomes between 190 and 253 percent of the FPL; (d) receive benefits only by virtue of the Comprehensive demonstration; and (e) meet the citizenship and identity requirements specified in the Deficit Reduction Act of 2005. Expenditures for Medicaid state plan benefits to extend the postpartum eligibility period from the end of the month in which the 60th postpartum day occurs to the end of the 12th month following the end of the pregnancy.

Budget Population 8 [Substitute Care]: Expenditures for parents pursuing behavioral health treatment with children temporarily in state custody with income up to 200 percent of the FPL.

Budget Population 9 [Children with special health care needs (CSHCN) Alt.]: Expenditures for CSHCN (as an eligibility factor) who are 21 and under who would otherwise be placed in voluntary state custody below 300 percent SSI.

Budget Population 10 [Elders 65 and over]: Expenditure authority for those at risk for needing LTC with income at or below 250 percent of the FPL who are in need of home and community-based services (state only group).

Budget Population 14 [Serious Emotional Disability/Intellectual Developmental Disability (SED/IDD) children]. Expenditure authority for disabled children, who are not otherwise Medicaid or CHIP eligible who need care in either a psychiatric residential treatment facility (PRTF) or residential treatment services authorized under the Rhode Island Medicaid State plan and who would meet the SSI disability standards if only the child's income and

resources were counted. These children do not receive SSI cash payments due to family income and resource limits.

Budget Population 15 [Adults with disabilities at risk for long-term care]:

Expenditures for HCBS waiver like services for adults living with disabilities with incomes at or below 400 percent of the SSI Federal Benefit Rate (FBR) with income and resource levels above the Medicaid limits.

Budget Population 16 [Uninsured adults with mental illness]: Expenditures for a limited benefit package of supplemental services for uninsured adults with mental illness and/or substance abuse problems with incomes above 133 and below 200 percent of the FPL not eligible for Medicaid. The benefits do not meet Minimum Essential Coverage (MEC) requirements.

Budget Population 17 [Youth at risk for Medicaid]: Expenditures for coverage of detection and intervention services for at-risk young children not eligible for Medicaid who have incomes up to 300 percent of SSI, including those with special health care needs, such as Seriously Emotional Disturbance (SED), behavioral challenges and/or medically dependent conditions, who may be safely maintained at home with appropriate levels of care, including specialized respite services.

Budget Population 18 [HIV]: Expenditures for a limited benefit package of supplemental HIV services for persons living with HIV with incomes above 133 percent of the FPL and below 200 percent of the FPL, and who are ineligible for Medicaid. The benefits do not meet Minimum Essential Coverage (MEC) requirements.

Budget Population 19 [Non-working disabled adults]: Expenditures for a limited benefit package of supplemental services for non-working disabled adults with disabilities ages 19-64 eligible for the General Public cash assistance program with income above 133 percent of the FPL, but who do not qualify for disability benefits. The benefits do not meet Minimum Essential Coverage (MEC) requirements.

Budget Population 20 [Alzheimer adults]: Expenditure authority for adults aged 19-64 who have been diagnosed with Alzheimer's Disease or a related Dementia as determined by a physician, who are at risk for LTC admission, who are in need of home and community care services, whose income is at or below 250 percent of the FPL.

Budget Population 21 [Beckett aged out]: Expenditure authority for young adults aged 19-21 aging out of the Katie Beckett eligibility group with incomes below 250 percent of the FPL, who are otherwise ineligible for Medicaid, are in

need of services and/or treatment for behavioral health, medical or developmental diagnoses.

2. Expenditures Related to Eligibility Expansion for 217-like groups.

Expenditures for Comprehensive demonstration beneficiaries who are age 65 and older and adults age 21 and older with disabilities and who would otherwise be Medicaid-eligible under section 1902(a)(10)(A)(ii)(VI) of the Act and 42 CFR §435.217 in conjunction with section 1902(a)(10)(A)(ii)(V) of the Act, if the services they receive under the Comprehensive demonstration were provided under an HCBS waiver granted to the state under section 1915(c) of the Act. This includes the application of spousal impoverishment eligibility rules.

Budget Population 11: Expenditures for 217-like Categorically Needy Individuals receiving HCBS-like services & PACE-like participants Highest need group.

Budget Population 12: Expenditures for 217-like Categorically Needy Individuals receiving Home and Community Based Services (HCBS) and PACE-like participants in the High need group.

Budget Population 13: Expenditures for 217-like Medically Needy receiving HCBS-like services in the community (High and Highest group). Medically Needy PACE-like participants in the community.

3. Budget Services 1 [Window Replacement]: Expenditures for window replacement for homes which are the primary residence of eligible children who are lead poisoned.

4. Budget Services 2 [RIte Share]. Expenditures for part or all of the cost of private insurance premiums and cost sharing for eligible individuals which are determined to be cost-effective using state-developed tests that may differ from otherwise applicable tests for cost-effectiveness.

5. Marketplace Subsidy Program: The state may claim as allowable expenditures under the demonstration, the payments made through its state-funded program to provide premium subsidies for parents and caretakers with incomes above 133 percent of the FPL through 175 percent of the FPL who purchase health insurance through the Marketplace Subsidies will be provided on behalf of individuals who: (1) are not Medicaid eligible; (2) are eligible for the advance premium tax credit (APTC); and (3) whose income is above 133 percent of the FPL through 175 percent of the FPL.

6. Designated State Health Program (DSHP)

If applicable, budgetary limits for the following Designated State Health

Programs (DSHP) are set forth in the STCs.

Budget Population 23: Expenditures for cost of designated programs that provide or support the provision of health services that are otherwise state-funded, as specified in STC 79.

7. Demonstration Benefits.

- a. Expenditures for benefits specified in Attachment A of the STCs provided to demonstration populations, which are not otherwise available in the Medicaid State Plan.
- b. Expenditures for the provision of HCBS that are not otherwise available under the approved State plan, after accounting for beneficiary share of post-eligibility cost of care.
- c. Expenditures for core and preventive services and home and community-based therapeutic services as identified in Attachment B for Medicaid eligible youth who are at risk youth for out-of-home care or hospitalization and adults with a behavioral health diagnosis and/or developmental disability (**Budget Services 4**).

8. Expenditures for Healthy Behaviors Incentives.

9. Long-Term Care Benefits Pending Verification of Financial Eligibility Criteria for New LTC Applicants. Expenditures for a limited set of LTC benefits for individuals who self-attest to financial eligibility factors as specified in STC 24.

10. Expenditures for Recovery Navigation Program (Budget Services 5).

Expenditures to deliver a recovery-oriented environment and care plan dedicated to connecting individuals with a substance use disorder eligible for RNP services as specified in STC 90, with the necessary level of detox, treatment, and recovery services within a less-intensive and less-costly level of care than is furnished in an inpatient hospital setting.

11. Expenditures for Peer Recovery and Family/Youth Support Specialist Program (Budget Services 6).

Expenditures to deliver services using a Peer Recovery or Family/Youth Support Specialist who provides an array of interventions that promote socialization, long-term recovery, wellness, self-advocacy, and connections to the community, as well as offer services, as outlined in STC 99, that will focus on the treatment of mental health and/or substance use disorders for those individuals who have trouble stabilizing in the community and/or are in need of supports to maintain their stability in the community.

12. Expenditures for Family Home Visitation Program (Budget Services 7)

Expenditures to deliver evidence-based home visiting services in identified areas throughout the state to as outlined in STC 32.

13. Expenditures for Home Based Primary Care Services (Budget Services 8)

Expenditures to deliver home based primary care and related services to Medicaid-eligible individuals who are homebound, have functional limitations that make it difficult to access office-based primary care, or for whom routine office-based primary care is not effective because of complex medical, social, and/or behavioral health conditions, as outlined in STC 33.

14. Expenditures for Behavioral LINK Program (Budget Services 9)

Expenditures to deliver the services within one Behavioral Health Link (BH Link) triage center, to support crisis stabilization and short-term treatment for individuals experiencing a behavioral health (mental health or substance use disorder) crisis, as outlined in STC 104.

15. Expenditures for the Dental Case Management Pilot (Budget Services 10)

Expenditures to operate a Dental Case Management Pilot project, in 6 dental offices, to use four new dental case management service codes to determine the potential effectiveness in advancing health care coordination, improved oral health literacy and alleviating transportation barriers in dental offices to support patient compliance, as outlined in STC 109.

16. Residential and Inpatient Treatment for Individuals with Substance Use Disorder (Budget Services 11). Expenditures for otherwise covered services furnished to otherwise eligible individuals who are primarily receiving treatment and withdrawal management services for SUD who are short-term residents in facilities that meet the definition of an institute for mental diseases (IMD).

17. Expenditures for Home Stabilization Services (Budget Services 12)

Expenditures for home stabilization services described in STC 26.

18. Expenditures for Telephonic Psychiatric Consultation Services (Budget Services 13).

Expenditures for telephonic psychiatric consultation services as described in described in STC 109.

Title XIX Requirements Not Applicable to Budget Population 5:

Amount, Duration, and Scope

Section 1902(a)(10)(B)

To enable Rhode Island to provide a benefit package consisting only of approved

family planning and family planning-related services.

Title XIX Requirements Not Applicable to Budget Populations 10, 15, 16, 17, 18, 19, 20

Amount, Duration, and Scope

Section 1902(a)(10)(B)

To enable Rhode Island to provide a limited benefit package.

CHIP Expenditure Authority

Expenditures for medical assistance for children through age 18 whose family income is equal to or less than 261 percent of the FPL and who are not otherwise eligible under the approved Medicaid state plan. [Budget Population 7]

CENTERS FOR MEDICARE & MEDICAID SERVICES

SPECIAL TERMS AND CONDITIONS

NUMBER: 11-W-00242/1

TITLE: Rhode Island Comprehensive Section 1115 Demonstration

AWARDEE: Rhode Island Executive Office of Health and Human Services

I. PREFACE

The following are the Special Terms and Conditions (STCs) for the “Rhode Island Comprehensive Demonstration” section 1115(a) Medicaid demonstration (hereinafter “demonstration”), to enable the Rhode Island Executive Office of Health and Human Services (hereinafter “state”) to operate this demonstration. The Centers for Medicare & Medicaid Services (CMS) has granted waivers of requirements under section 1902(a) of the Social Security Act (Act), and expenditure authorities authorizing federal matching of demonstration costs not otherwise matchable, which are separately enumerated. These STCs set forth conditions and limitations on those waivers and expenditure authorities, and describe in detail the nature, character, and extent of federal involvement in the demonstration and the state’s obligations to CMS related to this demonstration. These STCs neither grant additional waivers or expenditure authorities, nor expand upon those separately granted. The STCs are effective January 1, 2019, through December 31, 2024, unless otherwise specified. The STCs have been arranged into the following subject areas:

- I. Preface
- II. Program Description and Objectives
- III. General Program Requirements
- IV. Eligibility and Enrollment
- V. Demonstration Programs and Benefits
- VI. Cost Sharing
- VII. Delivery System
- VIII. Health System Transformation Project
- IX. Self-Direction
- X. Extended Family Planning Program
- XI. RIte Smiles
- XII. Other Programs
- XIII. Designated State Health Plans (DSHP)

- XIV.** Healthy Behavior Incentives Program
- XV.** Opioid Use Disorder/ SUD Program
- XVI.** Recovery Navigation Services
- XVII.** Peer Recovery Specialist (PRS) and Family/Youth Support Partners (FYSP) Programs
- XVIII.** Behavioral Health Link
- XIX.** Telephonic Psychiatric Consultation Services
- XX.** Dental Case Management Pilot
- XXI.** General Reporting Requirements
- XXII.** Monitoring
- XXIII.** Evaluation of the Demonstration
- XXIV.** General Financial Requirements Under Title XIX
- XXV.** Monitoring Budget Neutrality for the Demonstration
- XXVI.** Schedule of Deliverables for the Demonstration Extension Period

The following attachments have been included to provide supplemental information and guidance for specific STCs. The following attachments are incorporated as part of this Agreement.

- Attachment A: Managed Care Demonstration Only Benefits
- Attachment B: Core and Preventive Home and Community-based Service Definitions
- Attachment C: Assessment and Coordination Organization
- Attachment D: Level of Care Criteria
- Attachment E: Quarterly Report Progress Template and Instructions
- Attachment F: Evidentiary Review Guidance for HCBS
- Attachment G: Healthy Behaviors Incentives Program Description (reserved)
- Attachment H: Accountable Entities Certification Standards- Comprehensive AE
- Attachment I: Accountable Entities: Certification Standards- Specialized AE
- Attachment J: Accountable Entity Total Cost of Care Requirements
- Attachment K: Reserved
- Attachment L: Accountable Entity Road Map Document
- Attachment M: Accountable Entity Attribution Guidance
- Attachment N: Reserved
- Attachment O: Claiming Protocol – Other DSHPs
- Attachment P: Wavemaker Methodology and Claiming Protocol
- Attachment Q: Health Workforce Development Protocol
- Attachment R: Claiming Protocol – Health Workforce Development
- Attachment S: Deliverables Chart – 5 Years
- Attachment T: RNP Claiming Methodology Protocol
- Attachment U: RNP- Memoranda of Agreements (MOA) Template
- Attachment V: RNP Approved EOHHS Screening Tool

Attachment W: Developing the Evaluation Design
Attachment X: Preparing the Interim and Summative Evaluation Reports
Attachment Y: Evaluation Design
Attachment Z: SUD Implementation Plan Protocol
Attachment AA: SUD Monitoring Protocol Attachment
Attachment BB: Behavioral Link Component Services
Attachment CC: Behavioral Link Payment Methodology

II. PROGRAM DESCRIPTION AND OBJECTIVES

The Rhode Island Medicaid Reform Act of 2008 (R.I.G.L §42-12.4) directed the state to apply for a global demonstration project under the authority of section 1115(a) of Title XI of the Social Security Act (the Act) to restructure the state’s Medicaid program to establish a “sustainable cost-effective, person-centered and opportunity driven program utilizing competitive and value-based purchasing to maximize available service options” and “a results-oriented system of coordinated care.”

Under this demonstration, Rhode Island operates its entire Medicaid program subject to the financial limitations of this section 1115 demonstration project, with the exception of: 1) disproportionate share hospital (DSH) payments; 2) administrative expenses; 3) phased-Part D contributions; and 4) payments to local education agencies (LEA) for services that are furnished only in a school-based setting, and for which there is no third party payer.

With those four exceptions, all Medicaid funded services on the continuum of care – from preventive care in the home and community to care in high-intensity hospital settings to long-term and end-of life-care, whether furnished under the approved state plan, or in accordance with waivers or expenditure authorities granted under this demonstration or otherwise, are subject to the requirements of the demonstration. Rhode Island’s previous section 1115 demonstration programs, RItE Care and RItE Share, were subsumed under this demonstration, in addition to the state’s previous section 1915(b) Dental Waiver and the state’s previous section 1915(c) home and community-based services (HCBS) waivers.

The Rhode Island Comprehensive demonstration includes the following distinct components:

- a. The Managed Care component provides Medicaid state plan benefits as well as supplemental benefits as identified in Attachment A to most recipients eligible under the Medicaid state plan, including the new adult group. Benefits are provided through comprehensive mandatory managed care delivery systems. The amount, duration and scope of these services may vary

and limitations must be set out in the state plan, these STCs, or in demonstration changes implemented using the processes described in section IV of these STCs.

- b. The Extended Family Planning component provides access to family planning and referrals to primary care services for women individuals whose family income is at or below 200 percent of the federal poverty level (FPL), and who lose Medicaid or CHIP Targeted Low Income Pregnant Individuals eligibility under RIte Care at the conclusion of their 12-month postpartum period. Effective January 1, 2014, eligibility was raised to 253 percent of the FPL. See Section X for more detailed requirements.
- c. The RIte Share premium assistance component enrolls individuals who are eligible for Medicaid/CHIP, and who are employees or dependents of an employee of an employer that offers a “qualified” plan into the ESI coverage.
- d. The Rhody Health Partners component provides Medicaid state plan and demonstration benefits through a managed care delivery system to aged, blind, and disabled beneficiaries who have no other health insurance. Effective November 1, 2013, the Rhody Health Partners expanded to all qualified aged, blind, and disabled beneficiaries whether they have other health insurance or not. Effective January 1, 2014, the New Adult Group was enrolled in Rhody Health Partners. The amount, duration, and scope of these services may vary and limitations must be set out in the state plan, these STCs, or in demonstration changes implemented using the processes described in section IV of these STCs.
- e. The Home and Community-Based Services (HCBS) component provides services similar to those authorized under sections 1915(c) and 1915(i) of the Act to individuals who need HCBS either as an alternative to institutionalization or otherwise based on medical need. Effective January 1, 2019, the existing services will continue under the demonstration; any new state amendment request for HCBS will be authorized under the appropriate authority under of 1915(c) and 1915(i) and not through the 1115 demonstration. Upon CMS’s approval of the state’s September 12, 2023, section 1115 demonstration amendment application, and pursuant to section 3715 of the Coronavirus Aid, Relief, and Economic Security Act or the CARES Act, Pub. L. No. 116-136 (2020), the state is authorized to provide 1915(c)-like Personal Care Services (PCS) in acute care hospital settings under its existing HCBS expenditure authorities (budget populations 10, 11, 12, 13, 15, and 20 and expenditure authorities 7(b) and 7(c).
- f. The RIte Smiles Program is a managed dental benefit program for Medicaid eligible children and young adults born after May 1, 2000.

In 2013, CMS renewed the Comprehensive demonstration through December 31, 2018. This renewal included changes to support the state's implementation of the Affordable Care Act (including coverage of the new adult group for adults with incomes at or below 133 percent of the FPL), the expansion of the state's HCBS, and the conversion from an aggregate cap to a per member per month budget neutrality model.

On October 20, 2016, CMS approved an amendment that provides for federal funding of designated state health programs (DSHPs) that promote healthcare workforce development to ensure access to trained healthcare professionals for eligible individuals. The DSHP funding will be phased down over the period of the demonstration, as the state develops alternative funding sources for these programs. The state submitted an amendment on May 17, 2016 that requested federal funding of DSHPs to ensure the continuation of workforce training and other vital health care programs while the state devotes increased state resources during the period of this demonstration to a "Health System Transformation Project" that will positively impact the Medicaid program. For the period of this demonstration, DY 11 and DY 12, DSHP funding will be limited to the additional state funding attributable to the establishment of Accountable Care Entities participating in managed care arrangements through Medicaid managed care contracts, net of savings attributable to the operation of those entities and the costs associated with the Hospital and Nursing Home Incentive program.

In DY 8, Rhode Island's Executive Office of Health and Human Services (EOHHS) directed the managed care organizations (MCOs) to provide incentive payments to providers; the incentive payments were funded under the Hospital and Nursing Home Incentive program. EOHHS distributed the payments to the MCOs, which distributed the payments to their contracted providers consistent with EOHHS's directions. The incentive program paid out a one-time payment of \$20.5 million (total computable) to providers based on demonstrated achievement of pre-determined performance benchmarks measures that demonstrated institutional providers' efforts towards value-based contracting arrangements, cost effectiveness, and alignment with key clinical interventions.

The Accountable Entities (AEs) are responsible for improving the quality of care, and there will be Alternative Payment models established, between managed care and AEs through the development of value-based contracts. The amount of DSHP funding will be phased down over the period of the demonstration as the implementation costs associated with AEs diminish and savings resulting from their operations reduce funding needs.

The state developed an Accountable Entity Roadmap for the Health System Transformation Project (Roadmap) that contains requirements regarding the AE's accountability for the total costs of care and healthcare quality and outcomes for an

attributed population. The Roadmap will be updated annually to ensure that best practices and lessons are learned throughout implementation that can be leveraged and incorporated into the state's overall vision of delivery system reform. This Roadmap will demonstrate the state's ambition and outline what the state and its stakeholders consider the payment reforms required for a high quality and a financially sustainable Medicaid delivery system, as well as the state's sustainability plan, outlined in STC 44.

On February 8, 2018, CMS approved the category III change (an amendment) request from the state to give Rhode Island the authority to create two new programs: Recovery Navigation Program (RNP) and Peer Recovery Specialist Program (PRS). These programs offer services to Medicaid beneficiaries with certain chronic diseases and conditions. RNP is a recovery-oriented environment that will connect individuals with necessary resources such as detoxification treatments, care management, and/or other recovery services. The Peer Recovery Specialist (PRS) will be a credentialed health care professional who provides an array of interventions that promote socialization, long-term recovery, wellness, self-advocacy, and connections to the community.

On July 11, 2018, the state requested expenditure authority to receive FFP for services delivered to beneficiaries diagnosed with an Opioid Use Disorder (OUD) and other Substance Use Disorders (SUD) residing in an Institution of Mental Diseases (IMD). The state's goal to implement these initiatives will increase access to critical levels of care for Opioid Use Disorder (OUD) and other Substance Use Disorder (SUD), increase the use of evidence-based, SUD specific patient placement criteria and to set standards for residential treatment provider qualifications across the state. The IMD expenditure authority will allow some larger SUD residential treatment providers to assist the state in alleviating some of the access challenges that Rhode Island faces for ASAM III.1 – III.5 levels of care.

In its extension application, the state also requested authority for the following programs:

- Home-based primary care services
- Dental Case Management Pilot program;
- Family Home Visiting Services Program;
- Behavioral LINK Pilot Program;
- Home Stabilization Services;
- Telephonic Psychiatric Consultation Services; and
- Expansion of Eligibility for Children with Serious Emotional Disturbance (SED) who require residential treatment.

On February 6, 2020, CMS approved a section 1115(a) amendment authorizing telephonic psychiatric consultation services to expand access to behavioral health services and home stabilization services (home find services and home tenancy services) to address housing

instability for Medicaid beneficiaries at risk for institutionalization.

On March 21, 2024, CMS approved a section 1115(a) amendment authorizing 1915(c)-like personal care services in acute care hospital settings as well as state requests that the state included in its December 22, 2022, section 1115(a) extension application. These approved requests included long-term authority for virtual HCBS flexibilities that were previously approved under Attachment K COVID-19 PHE authority, authority for HCBS remote supports and monitoring, an increase in the income level for HCBS waiver-like services for adults with disabilities at risk for long-term care, changing the provider education requirements for home stabilization services, expanding the post-partum continuous eligibility period to 12 months, and updating federal poverty levels (FPL) to reflect the modified adjusted gross income (MAGI) conversion.

III. GENERAL PROGRAM REQUIREMENTS

- 1. Compliance with Federal Non-Discrimination Statutes.** The state must comply with all applicable federal statutes relating to non-discrimination. These include, but are not limited to, the Americans with Disabilities Act of 1990, Title VI of the Civil Rights Act of 1964, section 504 of the Rehabilitation Act of 1973, and the Age Discrimination Act of 1975.
- 2. Compliance with Medicaid and Child Health Insurance Program (CHIP) Law, Regulation, and Policy.** All requirements of the Medicaid program, or the Children's Health Insurance Program (CHIP) for the separate CHIP population, expressed in law, regulation, and policy statement, not expressly waived or identified as not applicable in the waiver and expenditure authority documents (of which these terms and conditions are part), apply to the demonstration.
- 3. Changes in Medicaid and CHIP Law, Regulation, and Policy.** The state must, within the timeframes specified in law, regulation, or policy statement, come into compliance with any changes in federal law, regulation, or policy affecting the Medicaid or CHIP programs that occur during this demonstration approval period, unless the provision being changed is expressly waived or identified as not applicable. In addition, CMS reserves the right to amend the STCs to reflect such changes and/or changes as needed without requiring the state to submit an amendment to the demonstration under STC 7. CMS will notify the state 30 business days in advance of the expected approval date of the amended STCs to allow the state to provide comment. Changes will be considered in force upon issuance of the approval letter by CMS. The state must accept the changes in writing.
- 4. Impact on Demonstration of Changes in Federal Law, Regulation, and Policy.**
 - a. To the extent that a change in federal law, regulation, or policy requires either a reduction or an increase in federal financial participation (FFP) for

expenditures made under this demonstration, the state must adopt, subject to CMS approval, a modified budget neutrality agreement for the demonstration as necessary to comply with such change. The modified agreement will be effective upon the implementation of the change. The trend rates for the budget neutrality agreement are not subject to change under this subparagraph.

- b. If mandated changes in the federal law require state legislation, the changes must take effect on the earlier of the day such state legislation becomes effective, or on the last day such legislation was required to be in effect under the law.

5. State Plan Amendments. The state will not be required to submit title XIX or XXI state plan amendments for changes affecting any populations made eligible solely through the demonstration. If a population eligible through the Medicaid or CHIP state plan is affected by a change to the demonstration, a conforming amendment to the appropriate state plan is required, except as otherwise noted in these STCs. In all such cases, the Medicaid state plan governs.

6. Changes Subject to the Amendment Process. Changes related to eligibility, enrollment, benefits, delivery systems, cost sharing, sources of non-federal share of funding, budget neutrality, and other comparable program elements must be submitted to CMS as amendments to the demonstration. All amendment requests are subject to approval at the discretion of the Secretary in accordance with section 1115 of the Act. The state must not implement changes to these elements without prior approval by CMS. Amendments to the demonstration are not retroactive and FFP will not be available for changes to the demonstration that have not been approved through the amendment process set forth in STC 7 below.

7. Amendment Process. Requests to amend the demonstration must be submitted to CMS for approval no later than 120 calendar days prior to the planned date of implementation of the change and may not be implemented until approved. CMS reserves the right to deny or delay approval of a demonstration amendment based on non-compliance with these STCs, including, but not limited to the failure by the state to submit required reports and other deliverables according to the deadlines specified therein.

Amendment requests must include, but are not limited to, the following:

- a. An explanation of the public process used by the state, consistent with the requirements of STC 15. Such explanation must include a summary of any public feedback received and identification of how this feedback was addressed by the state in the final amendment request submitted to CMS;
- b. A data analysis which identifies the specific “with waiver” impact of the proposed amendment on the current budget neutrality agreement. Such analysis must include current total computable “with waiver” and “without

waiver” status on both a summary and detailed level through the current approval period using the most recent actual expenditures, as well as summary and detailed projections of the change in the “with waiver” expenditure total as a result of the proposed amendment, which isolates (by Eligibility Group) the impact of the amendment;

- c. An up-to-date CHIP allotment worksheet, if necessary.
- d. A detailed description of the amendment, including impact on beneficiaries, with sufficient supporting documentation; and
- e. The state must provide updates to existing demonstration reporting and quality and evaluation plans. This includes a description of how the evaluation design and annual progress reports will be modified to incorporate the amendment provisions, as well as the oversight, monitoring and measurement of the provisions.

8. Extension of the Demonstration. States that intend to request demonstration extensions under sections 1115(e) or 1115(f) of the Act must submit extension applications in accordance with the timelines contained in statute. Otherwise, if the state intends to request a demonstration extension under section 1115(a) of the Act, the state must submit the extension application no later than 12 months prior to the expiration date of the demonstration. The Governor or Chief Executive Officer of the state must submit to CMS either a demonstration extension request that meets federal requirements at CFR section 431.412(c) or a phase-out plan consistent with the requirements of STC 10.

9. Compliance with Transparency Requirements 42 CFR Section 431.412.

As part of the demonstration extension requests the state must provide documentation of compliance with the transparency requirements 42 CFR Section 431.412 and the public notice and tribal consultation requirements outlined in STC 15, as well as include the following supporting documentation:

- a. Demonstration Summary and Objectives: The state must provide a narrative summary of the demonstration project, reiterate the objectives set forth at the time the demonstration was proposed and provide evidence of how these objectives have been met as well as future goals of the program. If changes are requested, a narrative of the changes being requested along with the objective of the change and desired outcomes must be included.
- b. Special Terms and Conditions: The state must provide documentation of its compliance with each of the STCs. Where appropriate, a brief explanation may be accompanied by an attachment containing more detailed information. Where the STCs address any of the following areas, they need not be documented a second time.
- c. Waiver and Expenditure Authorities: The state must provide a list along

with a programmatic description of the waivers and expenditure authorities that are being requested in the extension.

- d. Quality: The state must provide summaries of: External Quality Review Organization (EQRO) reports; managed care organization (MCO) reports; state quality assurance monitoring; and any other documentation that validates the quality of care provided or corrective action taken under the demonstration.
- e. Compliance with Budget Neutrality Cap: The state must provide financial data (as set forth in the current STCs) demonstrating the state's detailed and aggregate, historical and projected budget neutrality status for the requested period of the extension as well as cumulatively over the lifetime of the demonstration. CMS will work with the state to ensure that federal expenditures under the extension of this project do not exceed the federal expenditures that would otherwise have been made. In doing so, CMS will take into account the best estimate of current trend rates at the time of the extension. In addition, the state must provide up to date responses to the CMS Financial Management standard questions. If title XXI funding is used in the demonstration, a CHIP Allotment Neutrality worksheet must be included.
- f. Evaluation Report: The state must provide an evaluation report reflecting the hypotheses being tested and any results available. For the proposed extension period, the state must provide a narrative summary of the evaluation design, status (including evaluation activities and findings to date), and plans for evaluation activities during the extension period.
- g. Documentation of Public Notice 42 CFR section 431.408: The state must provide documentation of the state's compliance with public notice process as specified in 42 CFR section 431.408 including the post-award public input process described in 431.420(c) with a report of the issues raised by the public during the comment period and how the state considered the comments when developing the demonstration extension application.

10. Demonstration Phase-Out. The state may only suspend or terminate this demonstration in whole, or in part, consistent with the following requirements.

- a. Notification of Suspension or Termination: The state must promptly notify CMS in writing of the reason(s) for the suspension or termination, together with the effective date and a phase-out plan. The state must submit its notification letter and a draft phase-out plan to CMS no less than 6 months before the effective date of the demonstration's suspension or termination. Prior to submitting the draft phase-out plan to CMS, the state must publish on its website the draft phase-out plan for a 30-day public comment period. In addition, the state must conduct tribal consultation in accordance with its approved tribal consultation State Plan Amendment. Once the 30-day public comment period has ended, the state must provide

- a summary of each public comment received the state's response to the comment and how the state incorporated the received comment into a revised phase-out plan.
- b. The state must obtain CMS approval of the phase-out plan prior to the implementation of the phase-out activities. Implementation of phase-out activities must be no sooner than 14 calendar days after CMS approval of the phase-out plan.
 - c. Phase-out Plan Requirements: The state must include, at a minimum, in its phase-out plan the process by which it will notify affected beneficiaries, the content of said notices (including information on the beneficiary's appeal rights), the process by which the state will conduct administrative reviews of Medicaid eligibility for the affected beneficiaries, and ensure ongoing coverage for eligible individuals, as well as any community outreach activities.
 - d. Phase-out Procedures: The state must comply with all notice requirements found in 42 CFR §431.206, 431.210 and 431.213. In addition, the state must assure all appeal and hearing rights afforded to demonstration participants as outlined in 42 CFR §431.220 and 431.221. If a demonstration participant requests a hearing before the date of action, the state must maintain benefits as required in 42 CFR §431.230. In addition, the state must conduct administrative renewals for all affected beneficiaries in order to determine if they qualify for Medicaid eligibility under a different eligibility category as discussed in October 1, 2010, State Health Official Letter #10-008.
 - e. Federal Financial Participation (FFP): If the project is terminated or any relevant waivers suspended by the state, FFP must be limited to normal closeout costs associated with terminating the demonstration including services and administrative costs of disenrolling participants.

11. CMS Right to Terminate or Suspend. CMS may suspend or terminate the demonstration in whole or in part at any time before the date of expiration, whenever it determines, following a hearing that the state has materially failed to comply with the terms of the project. CMS will promptly notify the state in writing of the determination and the reasons for the suspension or termination, together with the effective date.

12. Finding of Non-Compliance. The state does not relinquish its rights to challenge CMS' finding that the state materially failed to comply.

13. Withdrawal of 1115(a) Authority. CMS reserves the right to withdraw waiver or expenditure authorities at any time it determines that continuing the waiver or expenditure authorities would no longer be in the public interest or promote the objectives of title XIX. CMS will promptly notify the state in writing of the determination and the reasons for the withdrawal, together with the effective date, and afford the state an opportunity to request a hearing to

challenge CMS' determination prior to the effective date. If a waiver or expenditure authority is withdrawn, FFP is limited to normal closeout costs associated with terminating the waiver or expenditure authority, including services and administrative costs of disenrolling participants.

- 14. Adequacy of Infrastructure.** The state will ensure the availability of adequate resources for implementation and monitoring of the demonstration, including education, outreach, and enrollment; maintaining eligibility systems; compliance with cost sharing requirements; and reporting on financial and other demonstration components.
- 15. Public Notice, Tribal Consultation, and Consultation with Interested Parties.** The state must comply with the state notice procedures as required in 42 CFR section 431.408 prior to submitting an application to extend the demonstration. For applications to amend the demonstration, the state must comply with the state notice procedures set forth in 59 Fed. Reg. 49249 (September 27, 1994) prior to submitting such request. The state must also comply with the public notice procedures set forth in 42 CFR section 447.205 for changes in statewide methods and standards for setting payment rates.

The state must also comply with tribal and Indian Health Program/Urban Indian Organization consultation requirements at section 1902(a)(73) of the Act, 42 CFR section 431.408(b), State Medicaid Director Letter #01-024, and contained in the state's approved Medicaid State plan, when any program changes to the demonstration, either through amendment as set out in STC 6 or extension, are proposed by the state.
- 16. Federal Financial Participation (FFP).** No federal matching funds for expenditures for this demonstration will take effect until the effective date identified in the demonstration approval letter, or later date if so identified elsewhere in these STCs or in the list of waiver or expenditure authorities.
- 17. Administrative Authority.** When there are multiple entities involved in the administration of the demonstration, the Single State Medicaid Agency must maintain authority, accountability, and oversight of the program. The State Medicaid Agency must exercise oversight of all delegated functions to operating agencies, MCOs and any other contracted entities. The Single State Medicaid Agency is responsible for the content and oversight of the quality strategies for the demonstration.
- 18. Common Rule Exemption.** The state must ensure that the only involvement of human subjects in research activities which may be authorized and/or required by this demonstration is for projects which are conducted by or subject to the approval of CMS, and which are designed to study, evaluate, or otherwise examine the Medicaid program – including public benefit or service programs; procedures for obtaining Medicaid benefits or services; possible changes in or alternatives to those programs or procedures; or possible changes in methods or level of payment for benefits or services under those

programs. CMS has determined that this demonstration as represented in these approved STCs meets the requirements for exemption from the human subject research provisions of the Common Rule set forth in 45 CFR 46.101(b)(5).

IV. Eligibility and Enrollment

19. Populations Affected and Eligible under the Demonstration.

All Medicaid state plan populations are in the demonstration. In addition, the populations for which expenditure authority is granted are also enrolled in the demonstration.

Mandatory and optional Medicaid and/or CHIP state plan groups derive their eligibility through the Medicaid State Plan or CHIP State Plan are subject to all applicable Medicaid laws and regulations except as expressly waived under authority granted by this demonstration. Those groups made eligible by virtue of the expenditure authorities expressly granted in this demonstration are subject to all applicable Medicaid and/or CHIP laws and regulations except as expressly identified as not applicable under expenditure authority granted by this demonstration.

20. Eligibility Determinations – ABD Related. Eligibility determinations for ABD related populations in the community must follow the income and resource methodologies of the SSI program and the current Medicaid state plan.

21. Eligibility/Post-Eligibility Treatment of Income and Resources for Institutionalized Individuals. In determining eligibility for institutionalized individuals, the state must use the rules specified in the currently approved Medicaid state plan. All individuals receiving institutional services must be subject to post-eligibility treatment of income rules set forth in section 1924 of the Act and 42 CFR 435.733.

22. Individuals Receiving Home and Community Based Services-

- a. **HCBS Quality Systems and Strategy.** The state is expected to implement systems that measure and improve its performance to meet the waiver assurances set forth in 42 CFR 441.301 and 441.302. The Quality Review, as specified in Attachment F, provides a comprehensive assessment of the state's capacity to ensure adequate program oversight, detect and remediate compliance issues, and evaluate the effectiveness of implemented quality improvement activities.
- b. **HCBS Electronic Visit Verification System.** The state must require the use of an Electronic Visit Verification System (EVV) for HCBS-like services that are personal care services (PCS) provided under this demonstration by January 1, 2020, and HCBS like-services that are home health care services provided under this demonstration by January 1, 2023.

The state must implement this requirement consistent with section 12006 of the 21st Century CURES Act.

- c. **For 1915(c) HCBS**, the state must have an approved Quality Assurance System and is required to work with CMS to develop approvable performance measures within 90 days following approval of the 1115 for the following waiver assurances (please see Attachment F for more detail):
- i. **Administrative Authority:** A performance measure should be developed and tracked for any authority that the State Medicaid Agency (SMA) delegates to another agency, unless already captured in another performance measure.
 - ii. **Level of Care:** Performance measures are required for the following two sub assurances: (1) applicants with reasonable likelihood of needing services receive a level of care determination; and (2) the processes for determining level of care are followed as documented. While a performance measure for annual levels of care is not required to be reported, the state is expected to be sure that annual levels of care are determined.
 - a) Categorically Needy Individuals at the Highest Level of Care. The state will use institutional eligibility and post eligibility rules for an individual who would only be eligible in the institution in the same manner as specified under 42 CFR 435.217, 435.726, and 435.236 and section 1924 of the Act, to the extent that the state operates a program under the demonstration using authority under section 1915(c) of the Act.
 - b) Categorically Needy Individuals at the High Level of Care. The state will use institutional eligibility and post eligibility rules for individuals who would not be eligible in the community because of community deeming rules in the same manner as specified under 42 CFR 435.217, 435.726, and 435.236 and section 1924 of the Act, to the extent that the state operates a program under the demonstration using authority under section 1915(c) of the Act.
 - c) Medically Needy at the High and Highest Level of Care. The state may apply the medically needy income standard plus \$400. Individuals requiring habilitation services will be eligible to receive those services with a High or Highest Level of Care. The state will otherwise use institutional eligibility rules, including the application of spousal impoverishment eligibility rules.
 - d) Program for All-Inclusive Care for the Elderly (PACE). For participants at the “highest” level of care, the state will use institutional eligibility and post eligibility rules for individuals

who would only be eligible in the institution in the same manner as specified under 42 CFR 435.217, 435.726 and 435.236 and section 1924 of the Act, if the state had section 1915(c) waiver programs. For participants at the “high” level of care, the state will use institutional eligibility and post eligibility rules for individuals who would not be eligible in the institution in the same manner as specified under 42 CFR 435.217, 435.726 and 435.236 and section 1924 of the Act, if the state had section 1915(c) waiver programs.

- iii. **Certified Providers:** The state must have performance measures that track that providers meet licensure/certification standards, that non-certified providers are monitored to assure adherence to waiver requirements, and that the state verifies that training is given to non- certified providers in accordance with the waiver.
- iv. **Service Plan:** The state must demonstrate it has designed and implemented an effective system for reviewing the adequacy of service plans for participants in accordance with 42 CFR 441.301(c)(1). Performance measures are required for choice of HCBS-like waiver services and providers, service plans address all assessed needs and personal goals, and services are delivered in accordance with the service plan including the type, scope, amount, duration, and frequency specified in the service plan.
- v. **Health and Welfare:** The state must demonstrate it has designed and implemented an effective system for assuring HCBS participants health and welfare. The state must have performance measures that track that on an ongoing basis it identifies, addresses and seeks to prevent instances of abuse, neglect, exploitation and unexplained death; that an incident management system is in place that effectively resolves incidents and prevents further singular incidents to the extent possible; that state policies and procedures for the use or prohibition of restrictive interventions are followed; and, that the state establishes overall health care standards and monitors those standards based on the responsibility of the service provider as stated in the approved waiver.
- vi. **Financial Accountability:** The state must demonstrate that it has designed and implemented an adequate system for insuring financial accountability of the HCBS. The state must have performance measures that track that it provides evidence that claims are coded and paid for in accordance for services rendered, and that it provides evidence that rates remain consistent with the approved rate methodology throughout the five-year waiver cycle.

Attachment F outlines the details of the sub assurances under each assurance listed above (i-vi).

- d. The state will submit an evidentiary report to CMS following receipt of an Evidence Request letter and report template from the Regional officer no later than 21 months prior to the end of the approved waiver demonstration period which includes evidence on the status of the HCBS quality assurances and measures that adhere to the requirements outlined in the March 12, 2014, CMS Informational Bulletin, Modifications to Quality Measures and Reporting in § 1915(c) Home and Community-Based Waivers. Following receipt of the state’s evidence report, the Regional Office will issue a Draft report to the state and the state will have 90 days to respond. The Regional Office will issue a Final report to the state 60 days following receipt of the state’s responses to the Draft report.
- e. The CMS Regional Office will evaluate each evidentiary report to determine whether the assurances have been met and will issue a final report to the state 12 months prior to the expiration of the demonstration.
- f. The state must also separately report annually the deficiencies found during the monitoring and evaluation of the HCBS assurances, an explanation of how these deficiencies have been or are being corrected, as well as the steps that have been taken to ensure that these deficiencies do not reoccur. The state must also report on the number of substantiated instances of abuse, neglect, exploitation and/or death, the actions taken regarding the incidents and how they were resolved. Submission is due no later than 6 months following the end of each demonstration year:

<i>Demonstration Year</i>	<i>Dates</i>	<i>Due dates</i>
<i>Demonstration Year 11</i>	<i>January 1, 2019, - December 31, 2019</i>	<i>June 30, 2020</i>
<i>Demonstration Year 12</i>	<i>January 1, 2020, - December 31, 2020</i>	<i>June 30, 2021</i>
<i>Demonstration Year 13</i>	<i>January 1, 2021, - December 31, 2021</i>	<i>June 30, 2022</i>
<i>Demonstration Year 14</i>	<i>January 1, 2022, - December 31, 2022</i>	<i>June 30, 2023</i>
<i>Demonstration Year 15</i>	<i>January 1, 2023, - December 31, 2023</i>	<i>June 30, 2024</i>

- g. **For 1915(i) HCBS**, the state must have an approved Quality Improvement Strategy and is required to develop performance measures to address the following requirements:

- i. Service plans that:
 - a) address assessed needs of 1915(i) participants;
 - b) are updated annually; and
 - c) document choice of services and providers.
 - ii. Eligibility Requirements: The state will ensure that:
 - a) an evaluation for 1915(i) State plan HCBS eligibility is provided to all applicants for whom there is reasonable indication that 1915(i) services may be needed in the future;
 - b) the processes and instruments described in the approved program for determining 1915(i) eligibility are applied appropriately; and
 - c) the 1915(i) benefit eligibility of enrolled individuals is reevaluated at least annually (end of each demonstration year- DY11-DY15) or if more frequent, as specified in the approved program.
 - iii. Providers meet required qualifications.
 - iv. Settings meet the home and community-based setting requirements as specified in the benefit and in accordance with 42 CFR 441.710(a)(1) and (2).
 - v. The SMA retains authority and responsibility for program operations and oversight.
 - vi. The SMA maintains financial accountability through payment of claims for services that are authorized and furnished to 1915(i) participants by qualified providers.
 - vii. The state identifies, addresses, and seeks to prevent incidents of abuse, neglect, and exploitation.
 - viii. The state must also describe the process for systems improvement as a result of aggregated discovery and remediation activities.
- h. The state must report annually to CMS the actual number of unduplicated individuals served and the estimated number of individuals for the following year. Submission to CMS is due at the end of each demonstration year- DY11-DY15.

23. Maintenance of Current Optional Populations. The state must maintain eligibility of all optional populations that are covered under the Rhode Island Medicaid State Plan as of November 1, 2008, except to the extent that this demonstration expressly permits changes in eligibility methods and standards. Any changes affecting these populations will be considered an amendment as specified in STC 7. In making any such changes, the state must give priority to extension or continuation of eligibility for optional populations prior to extension or continuation of eligibility for groups not otherwise eligible under the State Plan.

24. Expedited LTC Eligibility. The state may accept self-attestation of the

financial eligibility criteria for new LTC applicants for a maximum of ninety (90) days. Eligible individuals would be required to complete the LTC Clinical and Financial Application for LTC services. After Clinical Eligibility criteria has been verified by the state, the individual would provide a self-attestation of the LTC financial eligibility criteria to receive a limited benefit package of community based LTSS for up to 90 days pending the determination of the full LTC financial application. The limited benefit package includes a maximum of twenty (20) hours weekly of personal care/homemaker services and/or a maximum of three (3) days weekly of Adult Day Care Services and/or limited skilled nursing services based upon assessment. Upon determination of the approval of the full LTC financial application, the individual will receive the full LTC benefit package. The limited community based LTSS services is available for up to ninety (90) days or until the eligibility for LTC decision is rendered, whichever comes first.

V. DEMONSTRATION PROGRAMS and BENEFITS

25. **General.** Benefits provided through this demonstration program are as follows:

- a. RItE Care. Benefits are the full scope of benefits set forth in the approved state plan and this demonstration. Benefits are delivered through managed care organizations or managed care delivery systems, with the exception of certain services paid by the state on a fee-for-service basis, as outlined in the applicable managed care contract. Benefits that are available to RItE Care enrollees under this demonstration include all benefits listed in Attachment A and under the Medicaid State Plan.
- b. Alternative Benefit Plan. The New Adult Group receives benefits provided through the state's approved alternative benefit plan (ABP) state plan amendment (SPA), which are effective, as of the effective date in the approved ABP SPA. Individuals in the New Adult Group may receive, as part of their ABP under this demonstration, Expenditure Authority services such as those benefits specified in Attachment A of the STCs.
- c. Extended Family Planning Program. Family planning services and referrals to primary care services are provided to eligible recipients at or below 253 percent of the FPL who lose Medicaid or CHIP Targeted Low Income Pregnant Individuals eligibility at the conclusion of their 12-month postpartum period. See Section X for more detailed requirements.
- d. HCBS Beneficiary Protections. Long term care services are provided when medically necessary to certain individuals eligible under the Medicaid state plan. As indicated above, the New Adult Group will receive benefits provided through the state's approved ABP SPA. Benefit packages include long-term

care and home and community-based services based on medical necessity and an individual's person-centered plan of care. Beneficiaries may change managed care plans if their residential or employment support provider is no longer available through their current plan (MLTSS). The state will assure compliance with the characteristics of home and community-based settings as described in the applicable section 1915(c) and 1915(i) regulations in accordance with implementation/effective dates as published in the Federal Register.

- i. **Person-centered planning.** The state assures there is a person-centered service plan for each individual determined to be eligible for HCBS. The person-centered service plan is developed using a person-centered service planning process in accordance with 42 CFR 441.301(c)(1) (section 1915(c)) and 42 CFR 441.725(a) (section 1915(i)), and the written person-centered service plan meets federal requirements at 42 CFR 441.301(c)(2) (section 1915(c)) or 42 CFR 441.725(b) (section 1915(i)). The person-centered service plan is reviewed, and revised upon reassessment of functional need as required by 42 CFR 441.720, at least every 12 months, when the individual's circumstances or needs change significantly, or at the request of the individual. Person-centered planning meetings may take place virtually rather than in person. The state will establish a policy and process for accepting electronic signatures to be used to sign person-centered service plans when meetings are held virtually. When scheduling meetings, the state will ask individuals who request a virtual meeting whether they are able to use the technology to participate in a virtual meeting and what assistance they may need to do so. If the individual requires assistance before or during the meeting, the staff facilitating the meeting will offer that assistance (e.g., information on how to log into the meeting or the correct steps to access functions like screen sharing, etc.). As part of the Case Management service, all individuals, including those who choose to participate in virtual person-centered service planning, will receive an in-person contact at least once every six (6) months if this meets the individual's needs and preserves the health and welfare of the individual.
- ii. **Conflict of Interest:** The state agrees that the entity that authorizes the services is external to the agency or agencies that provide the HCBS. The state also agrees that appropriate separation of assessment, treatment planning and service provision functions are incorporated into the state's conflict of interest policies.

- e. Benefit packages for all individuals who meet the highest, or high-level of

care criteria will include access to core and preventive HCBS, and benefit packages for all individuals who meet the preventive level of care will include access to preventive HCBS as described in STC #26 and in Attachment B subject to any waiting list as described in STC 28. The core and preventive service HCBS definitions are included in Attachment B of this document.

- f. Limited Benefit Packages. Individuals in Budget Populations 10, 16, 18 and 20 are eligible for limited benefits under the demonstration. Benefit packages may include, but are not limited to, limited pharmacy, physical health, or mental health services.

26. Home Stabilization Services.

a. Eligibility

- i. Home Stabilization Services will be available to individuals who meet at least one of the following health needs-based criteria and is expected to benefit from the provision of Home Stabilization Services:
 - ii. The individual is assessed to have a mental health need, where there is a need for improvement, stabilization, or prevention of deterioration of functioning (including ability to live independently without support) resulting from the presence of a mental illness; and/or
 - iii. Any complex physical health need, which is defined as a long continuing or indefinite physical condition requiring improvement, stabilization, or prevention of deterioration of functioning (including ability to live independently without support).

AND

The individual has at least one of the following risk factors:

- iv. History of eviction and/or unstable housing (an individual must establish one of the following: notices from landlords/housing authorities to resolve issues, month-to-month housing agreements, couch surfing arrangements, or housing costs exceeding income /resources).
- v. History of frequent turnover of in-home caregivers, where within the last 12 months the individual utilized 3 or more different in-home caregiver provider agencies and the current placement is not appropriate for the individual.
- vi. History of institutionalization in a medical or penal facility including hospitals, Intermediate Care Facilities for People with Intellectual Disability (ICF/ID),

skilled nursing facilities, penal institutions nursing homes, Nursing Homes or other LTC housing, state hospitals, and any correctional facilities.

vii. Past or present substance use that interfered with ability to pay rent, maintain apartment according to lease, or created interpersonal issues that jeopardized housing.

b. Description of Services

- i. Home Stabilization Services are designed to ensure timely access to appropriate, high quality services for individuals who require support to establish or maintain a home. The goals of Home Stabilization Services include promoting living in the community successfully and reducing unnecessary institutionalization, addressing social determinants of health, and promoting a person-centered, holistic approach to care.
- ii. The state will use the Home Stabilization Certification Standards to certify providers to deliver either time-limited home tenancy teaching services for individuals who require support in obtaining and maintaining a home, or time-limited home find services to individuals who require support in finding and transitioning to housing. Home Tenancy Services and Home Find Services cannot be provided concurrently to a beneficiary and shall not be rendered for a total of more than 24 months.

b. Home Tenancy Services include:

- i. Coordinating and linking recipients to supports that assist in early identification and intervention for behaviors that may jeopardize housing, such as late rental payment and other lease violations;
- ii. Connecting the individual to education and training on the role, rights, and responsibilities of the landlord and tenant, as well as reinforcement of lessons to maximize the skills learned;
- iii. Providing supports to assist the individual in developing and maintaining key relationships with landlords/property managers with a goal of fostering successful tenancy;
- iv. Providing supports to assist the individual in resolving disputes with landlords/neighbors to reduce the risk of eviction or other adverse action;
- v. Assistance with linking the individual with community resources to prevent eviction when housing is, or may be jeopardized;
- vi. Providing supports to assist the individual with the housing

- recertification process;
 - vii. Coordinating with the tenant to review, update, and modify their housing support and crisis plan on a regular basis to reflect current needs and address existing or recurring housing retention barriers;
 - viii. Connecting the individual to training and resources that will assist the individual in being a good tenant and lease compliance, including on-going support with activities related to household management, as well as reinforcement of lessons to maximize the skills learned.
- c. Home Find Services include:
- i. Conducting tenant screening and housing assessments that identify the participants' preferences and barriers related to successful tenancy as part of the person-centered plan;
 - ii. Developing an individualized housing support plan based on housing assessment;
 - iii. Supports to assist the individual with the housing application and search process;
 - iv. Assist the individual in identifying resources to cover moving and start-up expenses and assist in arranging for and supporting the details of the move;
 - v. Ensuring that the living environment is safe and ready to move-in;
 - vi. Developing a housing support crisis plan.
2. The state will not cover the following services:
- a. Payment of rent or other room and board costs;
 - b. Capital costs related to the development or modification of housing;
 - c. Expenses for utilities or other regular occurring bills;
 - d. Goods or services intended for leisure or recreation;
 - e. Duplicative services from other state or federal programs; and
 - f. Services to individuals in a correctional institution or an IMD.
3. The state will review and approve each certified Home Stabilization Services provider's housing assessment tool.
4. Once a beneficiary is determined eligible for these services, the state must require that the provider submit to EOHHS a request for prior authorization to

provide time-limited services to the individual.

5. The state must require that the Home Stabilization Providers develop relationships with case managers from other community-based services and supports, including but not limited to healthcare providers, community mental health providers, permanent supportive housing providers, and community action programs. Home Stabilization services are intended to meet gaps in the provision of existing services and are intended to support housing retention; providers may not duplicate case management or home care services that are currently being provided in the community.
6. The state must provide training to Medicaid providers that addresses the scope of services, the Home Stabilization Services provider certification process, and the referral, authorization and billing requirements. This information must be available in person, in provider communications and provided through updates on the EOHHS website.

c) Provider Qualifications

1. The state must require that any Home Stabilization Services provider meet the Certification Standards for Home Stabilization Services codified in the Rhode Island Administrative Code at 210-RICR-20-00-1 and the state must require Home Stabilization Services providers to demonstrate compliance with Medicaid payment policies and provider certification standards.
2. The state must require that any Home Stabilization Services provider staff person providing direct support to clients must complete ongoing provider trainings offered by designees of the Rhode Island Continuum of Care, such as the Rhode Island Coalition for the Homeless, on topics that may include but are not limited to: Housing First, HIPAA, culturally informed care, Homeless Management Information System (HMIS), Motivational Interviewing, care coordination, and tenant's rights.
3. Supervisors of staff providing home find services and home tenancy services must have a Licensed Independent Clinical Social Worker (LICSW), Master of Social Work (MSW), Registered Nurse (RN), or other master's level degree.

Provider	Education and Experience (minimum)	Skills (preferred)	Services
Home Stabilization Services Provider	High School Diploma or General Educational (GED) Test and at least: with one (1) year of lived or professional experience; OR Bachelor's degree in a human/social services field.	Knowledge of principles, methods, and procedures of services included under Home Stabilization Services meant to support the client's ability to obtain and maintain residence in independent community settings.	Home Find Services and Home Tenancy Services

d) **Evaluation.** The state must submit an updated evaluation plan to CMS to address Home Stabilization Services for approval as required by STC 127. The state must generate its own hypothesis/es research question(s), outcomes used to address each research question, samples or subgroups to be compared, data sources, and analytic methods. The state must examine the effectiveness of the program and must include, at a minimum, the following research question and outcomes:

- i) Whether home stabilization services improve beneficiary health outcomes including:
 - a. pre- and post-home stabilization services living situation
 - b. number of inpatient admissions,
 - c. ED visits, including potentially avoidable utilization, and
 - d. frequency of admission to a nursing home, behavioral health facility, or inpatient acute care facility.

e) **Monitoring.** The state must include updates regarding the home stabilization services in its quarterly reports as required in STC 120.

27. Long-Term Care and HCBS Individuals eligible as aged, blind or disabled (ABD) under the Medicaid state plan will receive benefits for institutional and

home and community-based long term care services including an option for self-direction. Primary care for this population may be provided through mandatory or voluntary managed care or FFS programs. Based on a level of care determination, individuals eligible as ABD under the Medicaid state Plan can fall into the following groups: 1) highest, 2) high, and 3) preventive.

- a. Highest level of care. Individuals who are determined based on medical need to require the institutional level of care will receive services through nursing homes, long term care hospitals or intermediate care facilities for the mentally retarded (ICF/MR). Beneficiaries meeting this level of care will have the option to choose community-based care including core and preventive services as defined in Attachment B.
- b. High level of care. Individuals who are determined based on medical need to benefit from either the institutional level of care or a significant level of home and community-based services will have access to community based core and preventive services as defined in Attachment B.
- c. Preventive level of care. Individuals who do not presently need an institutional level of care will have access to services targeted at preventing admission, re-admissions or reducing lengths of stay in an institution. These beneficiaries will receive preventive services as defined in Attachment B.
- d. The state will assure compliance with the characteristics of home and community-based settings as described in the applicable section 1915(c) and 1915(i) regulations including waiver numbers 0040.90.R5 (Aged and Disabled), 0176.90.R3 (Elderly), 0335.90.R1 (Assisted Living), 0379.90.03 (Habilitation), 0041-IP.03 (Personal Choice), 0462 (Respite for Children-Hospital), 0463 (Respite for Children-ICF/MR), 0466 (Children with Mental Illness), 0162.90.R3 (MR/DD) in accordance with implementation/effective dates as published in the Federal Register.
- e. Primary and acute care services for Medicaid ABD eligible individuals meeting the highest, high or preventive level of care may be provided through Primary Care Case Management managed care or other managed fee-for-service (FFS). Individuals who are dually eligible for Medicare and Medicaid will receive primary and acute care services through Medicare FFS, a Medicare Advantage Plan, through the Program of All Inclusive Care for the Elderly (PACE), or other managed fee-for-service. This STC does not preclude the state from entering into other contract arrangements with entities that can provide these services. All individuals receiving HCBS must receive level of care evaluations, functional assessments, and person-centered service planning. Historically, these functions have only been available in face-to-face meetings. While in-person meetings will remain the default approach, beneficiaries now have the option to elect to receive evaluations,

assessments, and service planning telephonically or virtually. Telephonic and/or virtual options are available when medically appropriate and in accordance with the individual's service plan. When scheduling meetings for level of care evaluations, functional assessments, and/or person-centered planning, the state will ask individuals who request a virtual meeting whether they are able to use the technology to participate in a virtual meeting and what assistance they may need to do so. If the individual requires assistance before or during the meeting, the staff facilitating the meeting will offer that assistance (e.g., information on how to log into the meeting or the correct steps to access functions like screen sharing, etc.). As part of the Case Management service, all individuals, including those who choose to participate in virtual person-centered service planning, will receive an in-person contact at least once every six (6) months if this meets the individual's needs and preserves the health and welfare of the individual.

28. **Waiting List for HCBS.** Should a waiting list for long-term care services develop, the state must provide services for individuals classified in higher levels of care categories before providing services to individuals classified in lower categories. Specifically, participants receiving services must continue to receive services unless their condition improves and they move to a lower level of care category. Also, participants and applicants in the highest category are entitled to services and must not be put on a waiting list for institutional services. (If a community placement is not initially available, they may be put on a wait list for transition to the community.) Finally, applicants for the High group must receive services prior to applicants in the Preventive category.
29. **Long-Term Care Enrollment.** For those participants residing in an institution at the point of the initial implementation of the demonstration in January 2009, the state must apply pre-demonstration level of care criteria to those individuals unless the participant transitions to the community because he or she: (a) improves to a level where he or she would no longer meet the pre-demonstration institutional level of care, or (b) the individual chooses community care over institutional care. Once that participant is residing in the community, all future level of care redeterminations will be based on the new level of care criteria established for the purposes of this demonstration.
30. **Program for All-inclusive Care for the Elderly (PACE).** PACE is subsumed under this section 1115 demonstration program and will remain an option for qualifying demonstration eligibles, that is, those that meet the High or Highest level of care determinations. The state assures that demonstration eligibles who may be eligible for the PACE program are furnished sufficient information about the PACE program in order to make an informed decision about whether to elect this option for receipt of services. The state will comply with all Federal requirements governing its current PACE program, and any future expansion or new PACE program, in accordance with section 1934 of the

Social Security Act and regulations at Part 460 of Title 42 of the Code of Federal Regulations.

- 31. Long-Term Care Insurance Partnership.** The state must implement a Long-Term Care Insurance Partnership Program as described in the Rhode Island state plan. Under the Long-Term Care Insurance Partnership Program, an individual who is a beneficiary under a qualified long-term care insurance policy is given a resource disregard equal to the amount of insurance benefit payments made to or on behalf of the individual. The state does not seek adjustment or recovery from the individual's estate for the amount of assets or resources disregarded.
- 32. Medicaid Authorities Transition.** During the demonstration period, the state will evaluate which portions of the demonstration could be transitioned to 1915(c) and 1915(i) authorities. There will be a five-year transition plan as follows:
- a. January 2019 through December 2021 – CMS and the state conduct joint transition planning activities in order to identify which portions can be transferred.
 - b. January 2022 through December 2022 – The state will develop and submit 1915(c) and 1915(i) authorities for the portions to be transitioned for CMS review and approval.
 - c. January 2023 through December 2023 – Applications will be under review. The state and CMS will work to approve any 1915(c) waivers, 1915(i) SPAs and 1115(a) authorities requested, including, at a minimum those authorities in place through this 1115 demonstration as of December 2022.
 - d. January 2024- 1915(c) and 1915(i) waivers will be in effect.

33. Family Home Visiting Services Program

- a. Under the Family Home Visiting Services Program, the state will cover evidence-based home visiting services under the Nurse-Family Partnership (NFP) and Healthy Families America (HFA) statewide. The eligibility criteria for both the NFP and the HFA are set forth below:
 - i. Nurse-Family Partnership (NFP): Medicaid beneficiaries who are first time, pregnant individuals who enroll before 28-weeks' gestation and can remain eligible for the program, until their child is two years of age.
 - ii. Healthy Families America (HFA): Medicaid beneficiaries who are pregnant (does not have to be a first time pregnancy) or are parents of children under three months of age and can remain eligible until their child is four years old and the parent remains a Medicaid beneficiary.

- b. **Provider Qualifications:** To be eligible to provide evidence-based family

home visiting services, the state must require that provider must be certified by the Rhode Island Department of Health (RIDOH). RIDOH, with the national developers of NFP and HFA, has defined a set of standards for programs and agencies to provide services (Certification Standards). These Certification Standards are both specific to NFP and HFA and state requirements, to ensure compliance with specific NFP and HFA requirements, federal and state regulations, and to ensure the provision of quality services to eligible pregnant individuals and families with young children.

- c. The state must require that HFA providers must be certified as an HFA professional (under the HFA model) with training in infant mental health and have a minimum of one-year home visiting experience and a minimum of one to two years' experience working with families with young children and diverse populations.
- d. The state must require that NFP providers must have a Bachelor of Science in Nursing, a valid Rhode Island Nursing License, and must be certified as a Nurse Family Partnership professional with training in the Nurse Family Partnership curriculum and model.
- e. The following services will be covered during the prenatal and postpartum periods under the NFP and HFA unless otherwise specified:
 - i. **Prenatal Home Visiting Services-** The following evidence-based prenatal home visiting services are covered during the prenatal period:
 - a) Linkage to medical home
 - b) Immunization information and referral during pregnancy
 - c) Managing stress during pregnancy
 - d) Preparing for labor and delivery
 - e) Prenatal health and nutrition, including connection to WIC
 - f) Linkage to dental home
 - g) Home safety/getting the home ready for a newborn, including safe sleep
 - h) Family planning education
 - i) Depression screening and linkage to resources
 - j) Tobacco screening and linkage to cessation resources
 - k) Alcohol and substance use screening and linkage to resources
 - l) Interpersonal violence screening and linkage to resources
 - m) Planning for childcare, returning to work and/or school
 - n) Coaching expectant caregivers in their new role as parents
 - o) Link families with services in their community that support physical and social/emotional health
 - p) Social Determinants of Health Screening and linkage to

- resources (SNAP, Transportation, Housing etc.)
- q) Developing family goal plans

ii. **Postpartum Home Visiting Services-** The following evidence-based home visiting services are covered during the 90-day postpartum period (under 3 months of age):

- a) Diet and nutritional education for new mothers
- b) Maternal postpartum care, including postpartum care appointment
- c) Counseling regarding postpartum recovery
- d) Establishing ongoing medical home for parents
- e) Guidance and education with regards to well woman visits to obtain recommended preventive services
- f) Ensure caregivers have necessary vaccinations to protect newborn
- g) Stress management
- h) Positive parent and family health and wellbeing coaching
- i) STD prevention education
- j) Family planning education, inter-conception care
- k) Depression screening and linkage to resources
- l) Tobacco screening and linkage to cessation resources
- m) Alcohol and substance use screening and linkage to resources
- n) Interpersonal violence screening and linkage to resources
- o) Developing a plan to return to work and/or school
- p) Breastfeeding support and education
- q) Medical assessment of the postpartum mother and infant (NFP only);
- r) Coaching parents on how to respond to infant cues and supporting bonding and attachment
- s) Modeling and promoting positive parenting practices, including plans for discipline/behavior

iii. **Child Home Visit Services-** The following evidence-based home visiting services are covered for Medicaid eligible newborn infants born to beneficiaries enrolled in the NFP prenatally until the child reaches two or Medicaid eligible newborn infants born to beneficiaries enrolled in HFA prenatally or within three months of birth until the child reaches four years of age), as long as the child continues to be eligible for Medicaid and the demonstration is in effect:

- a) Caring for a newborn
- b) Education on child development and growth
- c) Establishing medical home
- d) Ensuring children are up-to-date on immunizations and attend well child visits
- e) Home safety assessment and education (e.g., safe sleep education for Sudden Infant Death Syndrome (SIDS) prevention)

- f) Balancing newborn needs while caring for other children (HFA only)
- g) Assessing quality of the home environment
- h) Developmental Screening and monitoring of child development
- i) Promoting Literacy and school readiness
- j) Promoting positive social emotional development and attachment
- k) Establishing a dental home for children
- l) Feeding and nutrition counseling
- m) Social determinants of health screening and linkage to resources.

34. Home Based Primary Care Program

- a) The Home Based Primary Care program addresses the needs of Medicaid-eligible individuals with complex medical, social, and/or behavioral health conditions that makes it difficult leaving their homes to access primary care services, including additional needed healthcare. The program will increase access to primary care, improve compliance with treatment, and reduce the burden of mobility challenges for high risk populations that are unable to, or have greater difficulty, accessing office or clinic-based services.
- b) Home based primary care and related services are covered under this program for Medicaid and CHIP eligible individuals who are homebound, have functional limitations that make it difficult to access office-based primary care, or for whom routine office-based primary care is not effective because of complex medical, social, and/or behavioral health conditions.
- c) Home Based Primary Care Providers. Qualified home based primary care services are approvable for FFP under this program when the services are rendered by an individual physician or team selected by or assigned to the member to provide and coordinate all of the member's health care needs. The assigned physician may initiate and monitor referrals for specialized services when required. Primary Care Providers shall be Medical Doctors or Doctors of Osteopathy in the following specialties:
 - i. Family and general practice,
 - ii. Pediatrics, gynecology, internal medicine,
 - iii. Geriatrics, or other medical specialists who have a demonstrated clinical relationship as the principal coordinator of care for children or adults and who are prepared to undertake the responsibilities of serving as a PCP.
 - iv. The Primary Care provider may designate other clinicians who can provide or authorize a member's care, including but not limited to Advanced Practice Practitioners- Certified Nurse Practitioners, and/or Physician Assistants. Advanced Practice Practitioners must provide documentation of evidence of a collaborative relationship with a Primary Care Physician, in which this physician agrees to

share responsibility for the care of patients. The designated physician shall agree to collaborate with the Advanced Practice Practitioner to ensure that members receive specialty and other referrals as necessary. The home-based primary care provider team composition may also include pharmacists, social workers and other practitioners, as credentialed and approved by EOHHS.

d) The Home Based Primary Care services include all health care services and laboratory services customarily furnished by or through a general practitioner, family practitioner, internal medicine physician, obstetrician/gynecologist, geriatric physician or other medical specialists, to the extent the furnishing of those services is legally authorized in the state in which the practitioner furnishes them. Home Based Primary Care services will be performed in the patient’s home and will be tailored to the patients’ needs and goals in order to treat the multiple chronic conditions and/or functional limitations of the individual.

VI. COST SHARING

35. Cost sharing imposed upon individuals enrolled in the demonstration is consistent with the provisions of the approved state plan. Demonstration populations may be charged premiums that do not exceed the premiums specified below.

36. Any premiums or copay requirements are specified in the Medicaid state plan. Demonstration populations may be charged premiums that do not exceed the premiums specified below.

Premium Limits for Budget Populations 3, 6, and 8					
Family Income Level	Children under 1*	Children 1 to 19th birthday*	Adults	Pregnant Individuals	Extended Family Planning
At least 150 percent but not more than 185 percent FPL	None	Up to 5 percent of family income	Up to 5 percent of family income	None	None

Over 185 percent but not more than 200 percent FPL	None	Up to 5 percent of family income	Up to 5 percent of family income	None	None
Over 200 percent but not more than 250 percent FPL	None	Up to 5 percent of family income	Up to 5 percent of family income	None	None
*No cost sharing or premiums for children in foster care or adoption subsidy			No cost-sharing for: pregnant individuals, children under age one (1), children in foster care or adoption subsidy, Chafee children, Alaskan Native/American Indian children and adults.		

VII. DELIVERY SYSTEM

37. Assessment and Coordination Organization Process. Access to institutional and community-based supports and services will be through the Assessment and Coordination Organization (ACO) process. The purpose of the ACO is to streamline the intake and assessment processes and provide beneficiaries and their families with clear, concise, and accurate information about their care options. The ACO process will involve the beneficiary and involved family members, and treating practitioners and providers to ensure comprehensive assessments and care planning. The ACO is described more fully in Attachment C.

38. Long-Term Care Services. Institutional and community-based long-term care services will be delivered through one of the following delivery systems:

- a. Managed Long Term Services and Supports. Beneficiaries will have access to long term care services and supports through their enrollment in managed care, PCCM, PACE or FFS.
- b. Fee-for-service. Beneficiaries will be able to access long-term care services through a fee-for-service system. Under this system, a beneficiary can choose the Medicaid participating agency or provider who will deliver the service(s). In turn, for those services requiring authorization or that are “out-of-plan,” the agency/provider bills the Medicaid agency for services authorized by the ACO

and/or the health plan.

- c. **Self-direction.** Beneficiaries (or, as they authorize, their families) will also have the option to purchase HCBS through a self-direction service delivery system. Under this option, beneficiaries will work with the ACO to develop a service plan identifying the budget amount and/or services needed. The beneficiary, with the support of a fiscal intermediary, will then be able to purchase services directly. This option is based on experience from Rhode Island's section 1915(c) Cash and Counseling Waiver (*RI Personal Choice*), section 1915(c) Developmental Disabilities Waiver, and Personal Assistance Service and Supports program. Self-direction is fully described in the Self-Direction Operations Section.

- 39. Primary and Acute Care Services.** Primary and acute care services will be delivered through the managed care, pre-paid dental ambulatory health plans, PACE, Premium Assistance, or FFS:
- 40. Contracts.** On those occasions that contracts with public agencies are not competitively bid, those payments under contracts with public agencies shall not exceed the documented costs incurred in furnishing covered services to eligible individuals (or a reasonable estimate with an adjustment factor no greater than the annual change in the consumer price index).
- 41. Freedom of Choice.** An enrollee's freedom of choice of providers through whom the enrollee may seek services may be limited. This applies to all populations enrolled in the Comprehensive demonstration. No waiver of freedom of choice is authorized for family planning providers.
- 42. Selective Contracting.** The state may pursue selective contracting in order to restrict the provider from (or through) whom an individual can obtain services. Emergency services and family planning services will not be covered by this provision. Providers with whom the state contracts will meet, accept, and comply with the reimbursement, quality, and utilization standards under the state plan, which standards shall otherwise be consistent with section 1923 of the Act. These standards are consistent with access, quality, and efficient and economic provision of covered care and services. Restrictions on providers will not discriminate among classes of providers on grounds unrelated to their demonstrated effectiveness and efficiency in providing those services.

If the state pursues selective contracting for nursing facilities, the state must submit, for CMS review and approval, a description of the process for selecting providers of nursing facility services and allocating nursing facility beds. The state must demonstrate that the process used to select providers of nursing facility services and to allocate Medicaid reimbursed nursing facility beds is consistent with access, quality, and efficient and economic provision of care and services for all participants needing nursing facility services including special regard to access

to services for individuals with complex long-term care needs.

43. Process for the Review and Approval of Contracts. The following process applies to contracts between the state and managed care organizations, pre-paid ambulatory health plans; primary care case management providers, and contracts pursuant to the selective contracting process.

All contracts listed above and modifications of existing contracts must be approved by CMS prior to the effective date of the contract or modification of an existing contract. The state will submit to CMS copies of the contracts or modifications and documentation supporting compliance with state and Federal statutes, regulations, special terms and conditions, and waiver and expenditure authority 60 days prior to implementation.

VIII. Health System Transformation Project

The Health System Transformation Project has Medicaid managed care entities enter into arrangements with state-certified Accountable Entities (AE) as a condition of receiving a managed care contract. Such contracts, including the AE provision, must meet the requirements of 42 CFR 438.

44. Accountable Entities. The following process applies to contracts between the state and managed care organizations (MCO) that require the contractor to subcontract with Accountable Entities (AE). AEs are integrated provider organizations that are accountable for the total cost of care and healthcare quality and outcomes of an attributed population.

- a. There will be two “types” of qualified AEs depending on the capacity and focus of the participating entities:
 - 1) Type 1 Accountable Entity: Total Population, All Services. Authority to contract for an attributed population, for all Medicaid services. A Type 1 AE must be accountable for the total cost of care of an attributed Medicaid population (a “TCOC methodology”).
 - 2) Type 2 Accountable Entity (Interim): Specialized Population, All Services. Authority to contract for a specialized population, for all Medicaid services. A Type 2 AE must be responsible for the total cost of care for a specific, defined population (e.g., persons with Serious or Persistent Mental Illness or Serious Mental Illness) and all Medicaid covered services. For specialized AEs where TCOC methodologies may not be appropriate, other APM models will be implemented.
- b. Rhode Island will require in its managed care contracts, that managed care entities will subcontract with state-certified AEs to provide accountability for the costs of care furnished under the contract.

- c. The state will use the AE Certification Standards to certify the potential AEs within the state. The final certification standards are described in Attachment H and I. The state will notify the MCOs of the approved certified AEs. After an organization is certified as an AE and it elects to make a material modification, a request for a substantive change (examples include a benefit enhancement, new provider network arrangements, change in AE governance), the state must review and approve such modification in the AE's operations, prior to the implementation of the AE.
- d. The certification standards will provide that AEs are integrated provider organizations that are accountable for the total cost of care and healthcare quality and outcomes of an attributed population. For specialized AEs where TCOC methodologies may not be appropriate, other APM models will be implemented. The MCOs, pursuant to contract requirements with the state, will subcontract with AEs in compliance with the In-Plan Medicaid managed care benefit package.
- e. EOHHS developed Alternative Payment Methodology (APM) guidelines, which MCOs must follow in contracting with certified AEs. This methodology includes quality benchmarks and outline the services that will be covered under the Type 1 and Type 2 Accountable Entities. The state must review and approve each MCO's APM methodologies and associated quality gates prior to implementation. The APM methodology document is Attachment H & I, APM Methodology Document and may be updated annually. The MCO must utilize the APM methodology to calculate the shared savings if applicable for each AE. MCO members will be attributed to an AE pursuant to the EOHHS Attribution Guidance for the AE Program- Attachment J, which may be updated annually.
- f. Certified AEs who contract with MCOs in accordance with state specified APM guidance will be eligible to participate in an AE Incentive Program. This APM guidance will include AE Incentive Program guidelines which MCOs must follow in contracting with certified AEs. The state must review and approve each MCO's AE Incentive Program as compliant with the standards.
- g. The MCO members' freedom to choose or change their providers shall not be affected by attribution to an AE. The state remains responsible for oversight of the MCOs and will augment oversight activities to ensure that the MCOs are assessing the performance of their AE subcontractors. The MCOs remain responsible for overseeing the services that are delegated to the subcontracted AEs so that the MCO remains compliant with the terms of both the contract it has with the state and as required under 42 CFR § 438.230(b)(1).

45. Accountable Entity Roadmap. The state developed an Accountable Entity Roadmap, Attachment M for the Health System Transformation Project. The Accountable Entity Roadmap contains requirements regarding the AE's accountability for the total costs of care and healthcare quality and outcomes for an attributed population. The Roadmap is considered a conceptualized living document that will be updated annually to ensure that best practices and lessons are learned throughout implementation that can be leveraged and incorporated into the State's overall vision of delivery system reform. The Roadmap may be altered only with CMS approval, and only to the extent consistent with the approved waivers, expenditure authorities and STCs. Changes to the AE Roadmap document will apply prospectively, unless otherwise indicated in the STCs. This Roadmap will demonstrate the state's ambition and outline what the state and its stakeholders consider the payment reforms required for a high quality and a financially sustainable Medicaid delivery system. Payments for each participating AE are contingent on the AE fully meeting project metrics defined in the approved APM guidance document – Attachment J. In order to receive incentive funding relating to any metric, the AE must submit all required reporting, as outlined in the Accountable Entity Roadmap.

The AE Roadmap must be updated by October 30, 2019, and annually thereafter to also include the state's Health System Transformation's Project's Sustainability plan. The Sustainability plan must outline that state's development of a viable AE business model when HSTP funds are depleted. Rhode Island's framework for sustainability will show the targeted progression from reliance on AE incentives to reliance on AE shared savings generated under the Total Cost of Care model.

In addition, the Roadmap must include the following elements:

- a. Specify that the APM guidance document will define a menu of metrics and measures that will be used by the MCOs to assess the performance of the AEs through the activities of the AE subcontractors.
- b. Include guidelines requiring AEs to develop individual AE Health System Transformation Project Plans, which shall include timelines and deadlines for the meeting of metrics associated with the projects and activities undertaken to ensure timely performance.
- c. Report to CMS any issues within the AEs that are impacting the AE's ability to meet the measures/metrics, or any negative impacts to enrollee access, quality of care or beneficiary rights. The state, working with the MCOs, shall monitor statewide AE performance, trends, and emerging issues within and among AEs on a monthly basis, and provide reports to CMS on a quarterly basis.

- d. Provide minimum standards for the process by which EOHHS seek public input in the development of the AE Certification Standards;
- e. Specify a State review process and criteria to evaluate each AE's its recommendation for approval or disapproval;
- f. Describe, and specify the role and function, of a standardized, AE-specific application to be submitted to the State on an annual basis for participation in the AE Incentive Program, as well as any data books or reports that AEs may be required to submit to report baseline information or substantiate progress;
- g. Specify that AEs must submit semi-annual reports to the MCO using a standardized reporting form to document its progress in achieving quality and cost objectives, that would entitle the AE to qualify to receive AE Incentive Program Payments
- h. Specify that each MCO must contract with Certified AEs in accordance with state defined APM guidance and state defined AE Incentive Program guidance. The APM guidance will include a Total Cost of Care (TCOC) methodology and quality benchmarks. For specialized AEs (Type 2 AE) where TCOC methodologies may not be appropriate, other APM models will be specified. Describe the process for the state to review and approve each MCO's APM methodologies and associated quality gates to ensure compliance with the standards and for CMS review of the APM guidance as stated in STC 43(e).
- i. Specify the role and function of the AE Incentive Program guidance to specify the methodology MCOs must use to determine the total annual amount of AE Incentive Program payments each participating AE may be eligible to receive during implementation. Such determinations described within the APM guidance document shall be associated with the specific activities and metrics selected of each AE, such that the amount of incentive payment is commensurate with the value and level of effort required; these elements are included in the AE incentive plans referenced in STC 43(f). Each year, the state will submit an updated APM guidance document, including APM Program guidance and the AE Incentive Program Guidance.
- j. Specify a review process and timeline to evaluate AE progress on its AE Incentive Program metrics in which the MCO must certify that an AE has met its approved metrics as a condition for the release of associated AE Incentive Program funds to the AE.

- k. Specify that an AE’s failure to fully meet a performance metric under its AE Incentive Program within the time frame specified will result in forfeiture of the associated incentive payment (i.e., no payment for partial fulfillment).
 - l. Describe a process by which an AE that fails to meet a performance metric in a timely fashion (and thereby forfeits the associated AE Incentive Program Payment) can reclaim the payment at a later point in time (not to exceed one year after the original performance deadline) by fully achieving the original metric and, where appropriate, in combination with timely performance on a subsequent related metric defined as demonstrating continued progress on an existing metric. For example, if the failed metric was related to developing a defined affiliation with a Community Business Organization or CBO, and that deliverable was late, the AE might then also be required to show it has adapted its governance model by incorporating into its bylaws and board protocols the requirement to develop a defined relationship with a CBO.
 - m. Include a process that allows for potential AE Health System Transformation Project Plan modification (including possible reclamation, or redistribution of incentive payments pending State approval).
 - n. Include a process to identify circumstances under which a plan modification may be considered, which shall stipulate that CMS may require that a plan be modified if it becomes evident that the previous targeting/estimation is no longer appropriate or that targets were greatly exceeded or underachieved; and
 - o. Include a State process of developing an evaluation of Health System Transformation Project as a component of the draft evaluation design as required by STC 127.
- 46.** Under the current managed care regulatory requirements for state direction of MCO payments (42 CFR 438.6(c)), Rhode Island will need to ensure that the measurement period of any of the performance based metrics and incentive payments within the Health Systems Transformation Project are developed and measured over the same term of the contract as the corresponding rate certification. The state will also need to meet the prior approval requirements for directed expenditures (e.g., incentive payments) in 438.6(c)(2) for contracts with rating periods starting on or after July 1, 2017. CMS will not approve rate certifications or contracts that include directed expenditures that have not been approved prior to the start of the rating period.

IX. SELF-DIRECTION

- 47. Required Elements of Self-Direction.** The state must meet the following requirements to operate its self-direction program for core and preventive services including through a High-Fidelity Wraparound process to assess the needs of the whole family, for children in residential treatment who are transitioning back to a home-based setting.
- 48. Voluntary Program.** The program is voluntary for demonstration eligibles who are eligible for and receiving home and community based long-term care services and supports.
- 49. Paid Providers of Services.** For adults participating in Self-Direction, the following individuals may be paid providers of self-directed services and supports and may be hired by the *adult* participant or the individual's representative: any individual who is capable of providing the assigned tasks, meets the requirements of the position, is freely chosen by the participant, and is *not* a representative as defined in STC 61. Parents and other non-spouse relatives of the *adult* participant may be paid providers of services as long as they meet the above requirements. For adult participants, spouses cannot be a paid provider of self-directed services.

For minor participants/ children, parents may *not* be paid providers of services. For minor participants/ children, paid providers of services must also not be a representative as defined in STC 61. For minor participants/children, the following individuals may be paid providers of self-directed services and supports and may be hired by the child's representative as defined in STC 61: any individual who is capable of providing the assigned tasks, meets the requirements of the position, is freely chosen by the participant, and is *not* a representative as defined in STC 61.

For both adult and minor participants, participants retain the right to: 1) train their employees in the specific areas of services and supports needed; 2) have those services and supports furnished in a manner that comports with the participants' personal, cultural, and/or religious preferences; and 3) access other training provided by or through the state for their employees so that they can meet any additional qualifications required or desired by the participants. For both adult and minor participants, the family member may be either the individual's representative as defined in STC 61 OR the paid provider of self-directed services, but not both.

- 50. Information Furnished to Participants.** The following information must be provided to participants: principles and benefits of participant direction; participants' rights, roles and responsibilities; self-direction election form; description of other feasible alternatives; fiscal/employer agent contact information; counseling/service advising agency contact information; grievance and appeal process and forms; roles and responsibilities of the fiscal/employer

agent and the counseling/advising agency; and participant-directed planning. Trained advisers from the service advisement agency will provide the information to participants.

- 51. Assessment.** An assessment of an individual’s needs, strengths, and preferences for services, as well as any risks that may pose a threat of harm to the individual, will be completed. The assessment includes information about the individual’s health condition, personal goals and preferences, functional limitations, age, school, employment, household and other factors that are relevant to the authorization and provision of services. The assessment information supports the development of the person-centered service plan and/or individual budget.
- 52. Person-Centered Planning.** The state must utilize a person-centered and directed planning process, intended to identify the strengths, capacities, preferences, needs, and desired outcomes of the participant. An Individual Service and Spending Plan (ISSP) is developed with the assistance of the service advisor team and those individuals the participant chooses to include. The ISSP includes the services and supports that the participant needs to live independently in the community. A back-up plan must be developed and incorporated into the ISSP to assure that the needed assistance will be provided in the event that the regular services and supports identified in the ISSP are temporarily unavailable. The back-up plan may include other individual assistants or agency services. The state shall have a process that permits participants to request a change to the person-centered plan, if the participant’s health circumstances necessitate a change, but in any event, the ISSP will be reviewed and updated at least annually. Entities or individuals that have responsibility for service plan development may not provide other direct demonstration services to the participant.
- 53. Employer Authority.** Participants have the opportunity to exercise choice and control (i.e., hire, fire, supervise, manage) over individuals who furnish their long term care demonstration services authorized in the person-centered service plan. In this demonstration, the participant functions as the employer of record of workers who furnish direct services and supports to the participant.
- 54. Budget Authority.** Participants also have the opportunity to exercise choice and control over a specified amount of funds in a participant-directed budget. Under the budget authority, the participant has decision-making authority and management responsibility for the participant-directed budget from which the participant authorizes the purchase of long term care demonstration services and supports that are authorized in the person-centered service plan.
- 55. Individual Budget.** An individual budget is the amount of funds available to the participant to self-direct. It is developed using a person-centered planning process; based on actual service utilization and cost data and derived from reliable sources; developed using a consistent methodology to calculate the resources available to each participant that is open to public inspection; and reviewed

according to a specified method and frequency. If an individual budget is established, a change in the budget must also result in a change to the person-centered plan.

56. Information and Assistance in Support of Participant Direction. The state shall have a support system that provides participants with information, training, counseling, and assistance, as needed or desired by each participant, to assist the participant to effectively direct and manage his or her self-directed services and/or budgets. Participants shall be informed about self-directed care, including feasible alternatives, before electing the self-direction option. Participants shall also have access to the support system throughout the time that they are self-directing their care. Support activities include, but are not limited to, advisement agency services and financial management services (if applicable).

57. Counseling/Advisement Agencies. The state shall provide each participant with a Service Advisor from a counseling/advisement agency that conducts participant screening, assessment and reassessment; participant orientation, training, preparation, and support of all participant functions; participant assistance in spending plan development and monitoring; and ongoing monitoring of participant satisfaction, health and safety. Counseling/advisement agencies shall meet state established certification standards to provide supports to participants.

58. Financial Management Services. The state shall provide financial management services (FMS) that: provide payroll services for program participants and/or designated representatives; are responsible for all taxes, fees, and insurances required for the program participant to act as an employer of record; manage all non-labor related payments for goods and services authorized in the participant's approved spending plan; assure that all payments made under the demonstration comply with the participant's approved spending plan; and conduct criminal background and abuse registry screens of all participant employees at the State's expense. FMS entities shall meet IRS requirements of being a fiscal/employer agent and state established certification standards to provide supports to participants. If the state claims FMS as an administrative activity, the state may contract with one vendor. If the state wants to claim FMS as a service reimbursable at FMAP for beneficiaries who self-direct, the state must allow any qualified provider to provide the service.

59. Services to be Self-Directed. Participants who elect the self-direction opportunity will have the option to self-direct all or some of the long-term care core and preventive services and supports under the demonstration. The services, goods, and supports that participants will self-direct are limited to the core and preventive services, listed in Attachment B. Services, goods, and supports that are not subject to employer and budget authority, i.e., participants do not have hiring authority and do not become the employer of record over these services, goods or items, will still be included in the calculations of participants' budgets.

Participants' budget plans will reflect the plan for purchasing these needed services, goods and supports.

60. Individual Directed Goods and Services. Individual directed goods and services may be purchased from accumulated funds (“savings”) as approved in the individual budget plan. Goods and services must relate to a need or goal identified in the person-centered service plan. Accumulated funds or savings may be carried over from month to month, and year to year, only if designated for a specific good or service. If the goods or services are not purchased at the time indicated in the budget plan, the state will recoup any unspent and un-earmarked funds at designated intervals and according to procedures established by the state. Goods and services that can be individually directed are defined in Attachment B Core and Preventive Services.

61. Participant Direction by Representative. The state provides for the direction of services by a representative. The representative may be a legal representative of the participant or a non-legal representative freely chosen by an adult participant. The representative shall not be paid and must pass a screen indicating ability to perform the functions in the best interest of the participant and must pass a criminal background check. A participant who demonstrates the inability to self-direct his or her services and supports whether due to misuse of funds, consistent non-adherence to program rules or an ongoing health and safety risk, will be required to select a representative to assist him or her with the responsibilities of self-direction. If a participant refuses to select a representative, or if a participant loses a representative (if already required for participation) and cannot locate a replacement, he or she will be required to transfer to a non-self-directed traditional service delivery system. Service advisors will assist the participant in the transition to the traditionally delivered service system to ensure continuity of care.

62. Independent Advocacy. Each participant shall have access to an independent advocate or advocacy system in the state. This function is performed by individuals or entities that do not provide direct services, perform assessments, or have monitoring, oversight or fiscal responsibilities for the demonstration.

63. Service Plan Monitoring. The Service Advisor shall, at a minimum, make quarterly in-person visits to the participant and monthly telephone contact in the first year, then semi-annual in-person and quarterly phone contact thereafter or more when requested or indicated by concern. Additionally, the RN and Mobility Specialist assess for needs at least annually. The entire Service Advisor Team is available to the participant upon request and/or Advisor identification of a potential health/safety concern.

64. Expenditure Safeguards. The FMS reports monthly to the participant and the Service Advisor, and quarterly to the state, on the budget disbursements and

balances. If more than 20 percent underutilization of authorized services is discovered, the Service advisor will work with the participant in assessing the reason and crafting a solution, such as a new worker or a reassessment of needs.

- 65. Disenrollment.** A participant may voluntarily disenroll from the self-directed option at any time and return to a traditional service delivery system. A participant may also be involuntarily disenrolled from the self-directed option for cause, such as a continuous demonstrated inability to self-direct his or her services and supports whether due to misuse of funds, consistent non-adherence to program rules or an ongoing health and safety risk. A participant who has demonstrated an inability to self-direct his or her services and supports will be required to select a representative to assist the participant with the responsibilities of self-direction. If a participant voluntarily or involuntarily disenrolls from the self-directed service delivery option, the state must have safeguards in place to ensure continuity of services.
- 66. Fair Hearing.** Participants may request a fair hearing when a reduction in services occurs or when a requested adjustment to the budget is denied or the amount of the budget is reduced.
- 67. Cash Option.** In such self-directed programs that include a budget, at such time as the state elects, a participant may elect to receive the amount of the funds in his or her individual budget in a prospective cash disbursement. Prior to the election of the cash option, the state will notify CMS of this election by sending a letter to CMS. Prior to implementation of the cash option, the state will secure a waiver of the income and asset requirements from the Social Security Administration.
- 68. Additional Populations and Services.** At such time as the state elects to add additional populations or services to the self-direction option, the state will notify CMS of this election by sending a letter to CMS. If, however, the state's proposal to add populations or services exceeds or changes the expenditure authorities of section 1915(c), 1915(i) or 1915(j), the state will follow the process for amendment requests.
- 69. Personal Needs Allowance.** The state may increase the monthly personal needs allowance by \$400 for certain persons categorically eligible or eligible as medically needy for Medicaid-funded long-term services and supports. These individuals will have resided in a nursing facility for 90 consecutive days, excluding those days that may have been used for the sole intent and purpose of short term rehabilitation; are transitioning from a nursing facility to a community residence, and are assessed to be unable to afford to remain in the community unless the personal needs allowance is increased. This would not apply to individuals who are residing in a nursing facility and whose income is being used to maintain a current community residence.

X. EXTENDED FAMILY PLANNING PROGRAM

- 70. Eligibility Requirements.** Family planning and family planning-related services and supplies are provided to individuals that are redetermined eligible for the program on an annual basis. The state must enroll only individuals, meeting the eligibility criteria below into the demonstration who have a family income at or below 253 percent of the FPL and who are not otherwise enrolled in Medicaid or Children’s Health Insurance Plan (CHIP). Individuals losing Medicaid or CHIP pregnancy coverage at the conclusion of 12 months postpartum and who have a family income at or below 253 percent of the FPL at the time of annual redetermination are auto enrolled in the Extended Family Planning group.
- 71. Primary Care Referral.** Primary care referrals to other social service and health care providers as medically indicated are provided; however, the costs of those primary care services are not covered for enrollees of this demonstration. The state must facilitate access to primary care services for participants, and must assure CMS that written materials concerning access to primary care services are distributed to demonstration participants. The written materials must explain to the participants how they can access primary care services.
- 72. Eligibility Redeterminations.** The state must ensure that redeterminations of eligibility for this component of the demonstration are conducted, at a minimum, once every 12 months. At the State’s option, redeterminations may be administrative in nature.
- 73. Disenrollment from the Extended Family Planning Program.** If an individual becomes pregnant while enrolled in the Extended Family Planning Program, she they may be determined eligible for Medicaid State Plan or the CHIP Targeted Low Income Pregnant Individuals group under the CHIP State plan. The state must not submit claims under the demonstration for any woman who is found to be eligible under the Medicaid or the CHIP Targeted Low Income Pregnant Individuals group in the CHIP State plan. In addition, individuals who receive a sterilization procedure and complete all necessary follow-up procedures will be disenrolled from the Extended Family Planning Program.
- 74. Extended Family Planning Program Benefits.** Benefits for the family planning expansion group are limited to family planning and family planning-related services. Family planning services and supplies described in section 1905(a)(4)(C) of the Act and are limited to those services and supplies whose primary purpose is family planning and which are provided in a family planning setting. Family planning services and supplies are reimbursable at the 90 percent matching rate, including:
- a. Approved methods of contraception;

- b. Sexually transmitted infection (STI) testing, Pap smears and pelvic exams;

Note: The laboratory tests done during an initial family planning visit for contraception include a Pap smear, screening tests for STIs/STDs, blood count and pregnancy test. Additional screening tests may be performed depending on the method of contraception desired and the protocol established by the clinic, program or provider. Additional laboratory tests may be needed to address a family planning problem or need during an inter-periodic family planning visit for contraception.

- c. Drugs, supplies, or devices related to women’s health services described above that are prescribed by a health care provider who meets the state’s provider enrollment requirements (subject to the national drug rebate program requirements); and
- d. Contraceptive management, patient education, and counseling.

75. Family Planning-Related Benefits. Family planning-related services and supplies are defined as those services provided as part of or as follow-up to a family planning visit and are reimbursable at the State’s regular Federal Medical Assistance Percentage (FMAP) rate. Such services are provided because a “family planning-related” problem was identified and/or diagnosed during a routine or periodic family planning visit. Examples of family planning-related services and supplies include:

- a. Colposcopy (and procedures done with/during a colposcopy) or repeat Pap smear performed as a follow-up to an abnormal Pap smear which is done as part of a routine/periodic family planning visit.
- b. Drugs for the treatment of STIs/STDs, except for HIV/AIDS and hepatitis, when the STI/STD is identified/ diagnosed during a routine/periodic family planning visit. A follow-up visit/encounter for the treatment/drugs and subsequent follow-up visits to rescreen for STIs/STDs based on the Centers for Disease Control and Prevention guidelines may be covered.
- c. Drugs/treatment for vaginal infections/disorders, other lower genital tract and genital skin infections/disorders, and urinary tract infections, where these conditions are identified/diagnosed during a routine/periodic family planning visit. A follow-up visit/encounter for the treatment/ drugs may also be covered.
- d. Other medical diagnosis, treatment, and preventive services that are routinely provided pursuant to family planning services in a family planning setting. An example of a preventive service could be a vaccination to prevent cervical

cancer.

- e. Treatment of major complications (including anesthesia) arising from a family planning procedure such as:
 - i. Treatment of a perforated uterus due to an intrauterine device insertion;
 - ii. Treatment of severe menstrual bleeding caused by a Depo-Provera injection requiring a dilation and curettage; or
 - iii. Treatment of surgical or anesthesia-related complications during a sterilization procedure.

76. Services. Services provided through the Extended Family Planning program are paid either through a capitated managed care delivery system or fee for service (FFS).

XI. RITE SMILES

77. Rite Smiles. The Rite Smiles Program is a managed dental benefit program that was previously operated under a waiver pursuant to section 1915(b) of the Act. Beneficiaries eligible for this program are Medicaid-eligible children and young adults born on or after May 1, 2000. The managed care delivery system is continuing under this demonstration. Under this demonstration, the state will continue to administer the program through a pre-paid ambulatory health plan contract. The benefit design will remain the same under this demonstration.

XII. OTHER PROGRAMS

78. Marketplace Subsidy Program. The state may claim as allowable expenditures under the demonstration the payments made through its state-funded program to provide premium subsidies for parents and caretaker relatives of Medicaid eligible and enrolled child(ren) with incomes above 133 percent of the FPL through 175 percent of the FPL who purchase health insurance through the Marketplace. The payments made by the Marketplace Subsidy Program shall not exceed 50 percent of the QHP's reduced premium amount, where the premium has been reduced each month by a) any federal tax credits a beneficiary is eligible for, and b) the amount a Medicaid beneficiary would have paid as his or her Medicaid monthly premium amount as of December 31, 2013 (between \$61 and \$92 per month), as demonstrated in the formula below.

*Maximum allowable payment by Marketplace Subsidy Program = 50% * (QHP Monthly Premium – Federal Tax Credits – 12/31/2013 Medicaid Monthly Premium Amount)*

Subsidies will be provided on behalf of individuals who: (1) have a child eligible for and enrolled in RIte Care; (2) are enrolled in a Marketplace plan that does not meet RIte Share requirements; and (3) whose income is above 133 percent of the FPL and at or below 175 percent of the FPL. For example, eligible individuals could be enrolled in a high deductible Marketplace plan, as such a plan would not meet RIte Share requirements.

Funding Limit. Expenditures for the subsidies are limited on an annual basis as follows (total computable). Expenditures for DYs 11-15 are contingent upon CMS approval of the evaluation report required in STC 128.

	DY 11 CY 2019	DY 10 CY 2020	DY 11 CY 2021	DY 12 CY 2022	DY 13 CY 2023
Marketplace Subsidy Limit	\$3,540,302	\$3,540,302	\$3,540,302	\$3,540,302	\$3,540,302

- f. **Reporting.** The state must provide data regarding the operation of this subsidy program in the quarterly reports required per STC 120. This data must, at a minimum, include:
 - i. The number of individuals served by the program each month;
 - ii. The amount of the subsidies; and
 - iii. A comparison of projected costs with actual costs.
- g. **Evaluation.** In DY 11 as part of the annual report, the state must evaluate the effect of the Marketplace Subsidy Program for enrollment in a QHP, using childless adults who are not eligible to receive a subsidy as a comparison group, as required per STC 77.
- h. **Budget Neutrality.** This subsidy program will be subject to the budget neutrality limit specified in STC 151.

79. Expenditures for Limited Benefit Budget Populations. The state provides for a limited benefit package of supplemental services for three populations:

- a. **Uninsured Adults with Mental Illness.** A limited benefit package of supplemental services for uninsured adults with mental illness and or substance abuse problems with incomes above 133 percent of the FPL and below 200 percent of the FPL who are ineligible for Medicaid.
- b. **Persons living with HIV.** A limited benefit package of supplemental HIV services for persons living with HIV with incomes above 133 percent of the FPL and below 200 percent of the FPL who are ineligible for Medicaid.

- c. Non-working disabled adults. A limited benefit package of supplemental services for non-working disabled adults ages 19-64 eligible for the General Public cash assistance program with incomes above 133 percent of the FPL, but who do not qualify for disability benefits.

XIII. DESIGNATED STATE HEALTH PROGRAMS (DSHP)

80. Health System Transformation Project (HSTP) Designated State Health Programs (DSHP). To solely support the goals of the Health System Transformation Project, the state may claim FFP for the following state programs subject to the annual limits and restrictions described below through December 31, 2020, unless otherwise specified. Designated State Health Programs enables the state to continue to improve health outcomes and increase the efficiency and quality of care by providing payments for services/activities (e.g., TB Program, etc.). Expenditures are claimed in accordance with CMS-approved claiming and documentation protocols to be specified in the Claiming Protocols; Attachment O, Attachment P, and Attachment R. In order to ensure achievement of the demonstration’s goals, the total annual expenditure authority is subject to the requirements of STC #83. CMS has approved expenditure authority for Designated State Health Programs (DSHP) with the agreement that this one-time (i.e., non-renewable) investment of DSHP funding will no longer be available after DY 12.

81. Total DSHP Limits – Expenditure authority for DSHP is limited to a total \$49,771,594 million FFP for DY 11 and DY 12 only, beginning on the date of approval through December 31, 2020, not to exceed the total aggregate limit of \$49,771,594 over the 2-year period. Each year has an annual DSHP limit listed in STC #81.

82. Annual DSHP Limits –The DSHP amounts are allocated by each year as follows:

Table 4: Aggregate DSHP Annual Limits

Demonstration Year	Time Period	Annual Limit on FFP
DY 11	1/1/19-12/31/19	\$25,987,745
DY 12	1/1/20-12/31/20	\$23,783,848

Allowable DSHP claims, for each program described below are limited to the allowable annual DSHP costs incurred for the months of the time period and Demonstration Year (DY) per the Table 4 not to exceed the annual aggregate limit for each DY.

83. Prohibited DSHP Expenditures. Allowable DSHP expenditures do not include any expenditures that are funded by federal grants (for example, grants

from the Health Resources and Services Administration, or the Centers for Disease Control, or that are included as part of the maintenance of effort or non-federal share requirements of any federal grant. Additionally, allowable DSHP expenditures do not include expenditures associated with the provision of non-emergency care to non-qualified aliens. To implement this limitation, 9 percent of total provider expenditures or claims through the Tuberculosis Clinic, Center for Acute Infectious Disease and Epidemiology, and Consumer Assistance Programs DSHPs identified below will be treated as expended for non-emergency care to non-qualified aliens.

84. Restrictions on DSHP Programs. Approved Designated State Health Programs for which FFP can be claimed for 2 years are outlined below subject to the following funding limits by the categories listed below. This funding will solely support vital state health programs and workforce development programs to enable the state to devote resources to developing and supporting the transition to Accountable Entities, which will result in a temporary increase in state expenditures on the Medicaid program over the term of these STCs. Prior to claiming funding for any of the new DSHPs, the state will submit a DSHP claiming protocol that CMS must approve prior to receiving FFP. The approved claiming protocol includes expenditures claimed in accordance with CMS-approved claiming and documentation protocols to be specified in Attachment O, Attachment P, and Attachment R. The state may claim federal match for any of the DSHPs listed below in accordance with the Claiming Protocol in Attachment O, Attachment P and Attachment R.

- Wavemaker Fellowship
- Tuberculosis Clinic
- Rhode Island Child Audiology Center
- Center for Acute Infectious Disease Epidemiology*
- Consumer Assistance Programs
- Health Workforce Development
- Elderly Transportation Program

a. **Wavemaker.** The state may claim FFP for expenditures under the Wavemaker Program for DYs 11 and 12. The Wavemaker Fellowship, a state-funded loan repayment program. The Wavemaker Fellowship will allow for graduates working in the healthcare settings to serve and make an impact on the health care of Medicaid beneficiaries. The state may claim FFP only for Fellowship costs that are conditional on loan repayment beneficiaries serving a high proportion of Medicaid patients. To ensure that DSHP funds promote the development of the Wavemaker Program to benefit the Medicaid population and improve access, the State shall commit to implementing a Methodology Protocol for the Wavemaker Program that will be Attachment R.

- b. **Tuberculosis Clinic- Department of Health.** For DYs 11 and 12, the state may claim FFP for expenditures otherwise uncompensated by Medicaid or third party payers that are incurred by the Tuberculosis Clinic within the Rhode Island Department of Health but are attributable to Medicaid and other low-income patients. The Tuberculosis Clinic is responsible for TB surveillance to detect cases and assures the availability of TB Specialty Clinical Services (adult and pediatric clinical services) to improve health outcomes and increase the efficiency and quality of care to all Rhode Island citizens.

- c. **Rhode Island Child Audiology Center- RI School for the Deaf.** For DYs 11 and 12, the state may claim FFP for expenditures otherwise uncompensated by Medicaid or third party payers that are incurred by the Rhode Island Child Audiology Center- RI School for the Deaf but are attributable to Medicaid and other low-income patients. The Audiology Center provides statewide hearing screening for children at all Rhode Island schools and will provide further diagnostic testing and referral for treatment for any child who screens at-risk for hearing loss.

- d. **Center for Acute Infectious Disease Epidemiology- RI Department of Health.** For DYs 11 and 12, the state may claim FFP for expenditures otherwise uncompensated by Medicaid or third party payers that are incurred by the state’s Center for Acute Infectious Disease Epidemiology within the Rhode Island Department of Health and are attributable to Medicaid and other low income patients. This program conducts surveillance, clinical case review and disease investigation for reportable infectious diseases to case manage, investigate and track diseases to reduce and control infectious diseases.

- e. **Consumer Assistance Programs- Executive Office of Health and Human Services.** For DYs 11 and 12, the state may claim FFP for expenditures related to the two specific programs within the Consumer Assistance Programs- Executive Office of Health and Human Services:
 - i. The Office of the Child Advocates (OCA) is an independent state agency responsible for protecting the legal rights and interests of all children in state care. These rights include, but are not limited to, a child’s right to healthcare and education.
 - ii. The Commission on the Deaf and Hard of Hearing. The Commission on the Deaf and Hard of Hearing (CDHH) coordinates, and provides services committed to promoting an environment in which the Deaf and Hard of Hearing in Rhode Island are afforded equal opportunity in all aspects of their lives.

- f. **Health Workforce Development.** For DYs 11 and 12, the state may claim

FFP for expenditures otherwise uncompensated by Medicaid or third party payers that are incurred to promote improved access and quality of care for Medicaid beneficiaries in Rhode Island by supporting the education and training of the health care workforce and to the extent that such education and training results in employment and/or continuing education of employees in settings that provide care and services in Rhode Island to Medicaid beneficiaries, the state may claim FFP for health workforce training programs and related supports at University of Rhode Island, Rhode island College and the Community College of Rhode Island. The annual limit the state may claim FFP for workforce training programs is limited to total costs, in accordance with the OMB Uniform Administrative Requirements, Cost Principles, and Audit Requirements for Federal Awards. To ensure that DSHP funds promote the development of workforce training to benefit the Medicaid population and improve access, the State shall commit to implementing the Health Workforce Development Methodology Protocol that will be Attachment S. The state shall also submit a claiming protocol specific to Health Workforce Development, Attachment T

- g. **Elderly Transportation Program.** For DYs 11 and 12, the state may claim FFP for expenditures otherwise uncompensated by Medicaid or third party payers that are incurred to improve access and quality of care by providing non-emergency medical transportation for elders 65 and older that are at risk for needing LTC and are in need of HCBS with income at or below 250 percent of the FPL.

85. Intervention for AEs Failing to Fulfill Requirements or Deliverables. Upon identification of performance issues within the AEs, the state shall intervene promptly within 30 days of identifying a concern to remediate the identified issue(s) and establish care improvements. Such remediation could include additional analysis of underlying data and gathering supplementary data to identify causes and trends, followed closely by interventions that are targeted to improve outcomes in the problem areas identified.

86. Reduction in DSHP Expenditure for Failure to Fulfill Requirements or Deliverables. The table below describes the deliverables the MCOs are required to meet for the state to qualify for DSHP funding. The DSHP will be reduced in the prospective demonstration year if the MCOs did not meet the target for the previous year. The state will have an additional 15 days' grace period (15 days after the due date) to fulfill requirements or submit necessary deliverables.

DY	Quality/Operational Improvement Targets	Due Date	% Reduction if State does not Meet
DY 8 CY 16	<i>To ensure prompt responses to CMS' questions regarding managed care rate development, CMS is adding the following items to the state's deliverable list. EOHHS will respond to CMS questions provided in writing to the state, regarding their managed care capitation rate development within 4 weeks of the request by CMS. If EOHHS anticipates that responses will not be available within the timeframe, EOHHS must notify CMS in writing, within 1 week of receipt of CMS request and request a reasonable extension, taking into account the content and volume of questions.</i>		
	EOHHS Responds to all CMS questions, received prior to 10/14/2016 regarding the 2015 managed care rate certification submissions.	Dec 1, 2016	15%
	EOHHS Submits to CMS their 2016 managed care rate certification	Dec 1, 2016	15%
DY 9 CY 17	EOHHS Submits the AE Roadmap document to CMS, including AE-Specific Health Transformation Project	June 1, 2017	10%
	EOHHS Submits their DSHP Claiming Protocols; Attachment P, Attachment Q, Attachment R and Attachment S	May 15, 2017	15%
	EOHHS Submits AE Certification Standards to CMS	June 1, 2017	10%
	EOHHS Submits Attribution Guidance to CMS	October 1, 2017	5%
	EOHHS Submits APM program guidelines to CMS, includes TCOC methodology and benchmarks	October 1, 2017	10%
DY 10 CY 18	Each MCO has at least 2 effective contracts (or 10% of covered lives) with Certified AEs in an EOHHS approved Alternative Payment Model as defined in Attachment L.	November 1, 2018	15%
	EOHHS Year 2 Guidance Posted, includes: APM Program Guidance, Attribution Guidance, and AE Incentive Program Guidance	December 15, 2018	5%

DY 11 CY 19	Each MCO with more than 60,000 covered lives has at least 2 effective contracts (or 20% of covered lives) with Certified AEs in an EOHHS approved Alternative Payment Model as defined in Attachment L.	July 1, 2019	10%
	EOHHS Year 3 Guidance Posted, includes: APM Program Guidance, Attribution Guidance, and AE Incentive Program Guidance	December 15, 2019	5%
	Applicable AEs have demonstrated meaningful achievement levels of pre-determined APM payment metrics established in the APM guidance document – Attachment L, for measurement period of July 1, 2018 through June 30, 2019.	December 31, 2019	5%
DY 12 CY 20	Each MCO with at least 60,000 covered lives has at least 3 effective contracts (or 30% of covered lives) with Certified AEs in an EOHHS approved Alternative Payment Model as defined in Attachment L.	July 1, 2020	10%
DY 13 CY 21	10% of covered lives, or at least one contract, shall be through an EOHHS Approved Alternative Payment Methodology that includes shared or full risk.	July 1, 2021	
DY 12 CY 20	EOHHS Year 4 Guidance Posted, includes: APM Program Guidance, Attribution Guidance, and AE Incentive Program Guidance	December 15, 2020	5%

DY 12 CY 20	Applicable AEs have demonstrated meaningful achievement levels for pre-determined APM payment metrics established in the APM guidance document – Attachment L, for measurement period of July 1, 2019 through June 30, 2020.	December 31, 2020	5%
----------------	--	-------------------	----

87. Specified Designated State Health Programs (DSHP). The following programs are authorized for claiming as DSHP, subject to the overall budget neutrality limit and DSHP limits described in section XIII of the STCs.

Table 6: List of Approved DSHPs

Agency	Program Name
<u>Previously Authorized Programs</u>	
EOHHS	Elderly Transportation Program
Rhode Island Department of Commerce	Wavemaker Fellowship
RI Department of Health	Tuberculosis Clinic
RI School for Deaf	Rhode Island Child Audiology Center
RI Department of Health	Center for Acute Infectious Disease Epidemiology
EOHHS	Consumer Assistance Programs
URI, RIC and CCRI	Health Workforce Development

XIV. HEALTHY BEHAVIORS INCENTIVES PROGRAM

88. Healthy Behaviors Incentives. Subject to federal approval, the state may establish a program based on incentives: individuals who adopt healthy behaviors may be eligible for rewards, such as a gift card for health-related goods. The program may also include penalties that disincentivize unhealthy behaviors. Such program may be a part of state’s efforts to reduce emergency room utilization, such as through the Communities of Care program.

Healthy Behaviors Incentives Protocols. The state is required to submit protocols pertaining to the program no later than 120 days prior to implementation

(Attachment G). Protocols must include, at a minimum, descriptions of the following:

- a. Populations impacted
- b. Incentives offered to beneficiaries
- c. Any penalties to disincentivize unhealthy behaviors
- d. Payment and financing methodologies, explaining which entities receive and administer funding, how incentive amounts are determined, and an explanation of any quality controls used to ensure proper use of funds.

XV. OPIOID USE DISORDER/SUBSTANCE USE DISORDER PROGRAM

89. Opioid Use Disorder/Substance Use Disorder Program. Effective upon CMS' approval of the OUD/SUD Implementation Plan Protocol, the demonstration benefit package for Rhode Island Medicaid recipients will include OUD/SUD treatment services, including short term residential services provided in residential and inpatient treatment settings that qualify as an Institution for Mental Diseases (IMD), which are not otherwise matchable expenditures under section 1903 of the Act. The state will be eligible to receive FFP for Rhode Island Medicaid recipients who are short-term residents in IMDs under the terms of this demonstration for coverage of medical assistance, including OUD/SUD benefits that would otherwise be matchable if the beneficiary were not residing in an IMD. Rhode Island must aim for a statewide average length of stay of 30 days in residential treatment settings, to be monitored pursuant to the SUD Monitoring Protocol as outlined in Section b below, to ensure short-term residential treatment stays. Under this demonstration, beneficiaries will have access to high quality, evidence-based OUD and other SUD treatment services ranging from medically supervised withdrawal management to on-going chronic care for these conditions in cost-effective settings while also improving care coordination and care for comorbid physical and mental health conditions.

The coverage of OUD/SUD treatment services and withdrawal management during short term residential and inpatient stays in IMDs will expand Rhode Island's current SUD benefit package available to all Rhode Island Medicaid recipients as outlined in Table 7, including peer support services authorized under 1115 demonstration authority as described in STC 99. Room and board costs are not considered allowable costs for residential treatment service providers unless they qualify as inpatient facilities under section 1905(a) of the Act.

Table 7: Rhode Island OUD/SUD Benefits Coverage with Expenditure Authority

SUD Benefit	Medicaid Authority	Expenditure Authority
Outpatient Services	State plan (Individual services covered)	
Intensive Outpatient Services	State plan (Individual services covered)	
Residential Treatment	State plan (Individual services covered)	Services provided to individuals in IMDs
Medically Supervised Withdrawal Management	State plan	Services provided to individuals in IMDs
Medication-Assisted Treatment (MAT)	State plan	Services provided to individuals in IMDs
Peer Recovery Support Services	1115 Demonstration	Services provided to individuals in IMDs

The state attests that the services indicated in Table 7, above, as being covered under Medicaid state plan authority are currently covered in the Rhode Island Medicaid state plan.

- a. **SUD Implementation Protocol.** The state must submit an OUD/SUD Implementation Protocol (referred to hereinafter as the SUD Implementation Plan) within 90 calendar days after approval of the SUD program under this demonstration. The state may not claim FFP for services provided in IMDs until CMS has approved the Implementation with this extension approval, CMS is also approving the SUD Implementation Plan and it has been incorporated into the STCs, as Attachment Z, and may be altered only with CMS approval. After approval of the Implementation Plan, FFP will be available prospectively, not retrospectively. Failure to submit an Implementation Protocol will be considered a material failure to comply with the terms of the demonstration project as described in 42 CFR 431.420(d) and, as such, would be grounds for termination or suspension of the OUD/SUD program under this demonstration. Failure to progress in meeting the

milestone goals agreed upon by the state and CMS will result in a funding deferral.

At a minimum, the SUD Implementation Plan must describe the strategic approach and detailed project implementation plan, including timetables and programmatic content where applicable, for meeting the following milestones which reflect the key goals and objectives of the SUD component of this demonstration program:

- i. **Access to Critical Levels of Care for OUD and other SUDs:** Service delivery for new benefits, including residential treatment and withdrawal management, within 12-24 months of OUD/SUD program demonstration approval;
- ii. **Use of Evidence-based SUD-specific Patient Placement Criteria:** Establishment of a requirement that providers assess treatment needs based on SUD-specific, multidimensional assessment tools, such as the American Society of Addiction Medicine (ASAM) Criteria or other assessment and placement tools that reflect evidence-based clinical treatment guidelines within 12-24 months of OUD/SUD program demonstration approval;
- iii. **Patient Placement:** Establishment of a utilization management approach such that beneficiaries have access to SUD services at the appropriate level of care and that the interventions are appropriate for the diagnosis and level of care, including an independent process for reviewing placement in residential treatment settings within 12-24 months of SUD program demonstration approval;
- iv. **Use of Nationally Recognized SUD-specific Program Standards to set Provider Qualifications for Residential Treatment Facilities:** Currently, residential treatment service providers must be a licensed organization, pursuant to the residential service provider qualifications described in Section 40.0 of the Rhode Island Rules and Regulations for the Licensing of Behavioral Healthcare Organizations. The state must establish residential treatment provider qualifications in licensure, policy or provider manuals, managed care contracts or credentialing, or other requirements or guidance that meet program standards in the ASAM Criteria or other nationally recognized, SUD-specific program standards regarding in particular the types of services, hours of clinical care, and credentials of staff for residential treatment settings within 12-24 months of OUD/SUD program demonstration approval;
- v. **Standards of Care:** Establishment of a provider review process to ensure that residential treatment providers deliver care consistent with the specifications in the ASAM Criteria or other comparable, nationally recognized SUD program standards based on evidence-based clinical treatment guidelines for types of services, hours of clinical care, and credentials of staff for

residential treatment settings within 12-24 months of SUD program demonstration approval;

vi. **Standards of Care:** Establishment of a requirement that residential treatment providers offer MAT on-site or facilitate access to MAT off-site within 12-24 months of SUD program demonstration approval;

vii. **Sufficient Provider Capacity at each Level of Care including Medication Assisted Treatment for OUD:** An assessment of the availability of providers in the key levels of care throughout the state, or in the regions of the state participating under this demonstration, including those that offer MAT within 12 months of SUD program demonstration approval;

viii. **Implementation of Comprehensive Treatment and Prevention Strategies to Address Opioid Abuse and OUD:** Implementation of opioid prescribing guidelines along with other interventions to prevent prescription drug abuse and expand coverage of and access to naloxone for overdose reversal as well as implementation of strategies to increase utilization and improve functionality of prescription drug monitoring programs;

ix. **SUD Health IT Plan:** Implementation of the milestones and metrics as detailed in Attachment Z; and

x. **Improved Care Coordination and Transitions between levels of care:** Establishment and implementation of policies to ensure residential and inpatient facilities link beneficiaries with community-based services and supports following stays in these facilities within 24 months of SUD program demonstration approval.

b. **SUD Monitoring Protocol.** The state must submit a SUD Monitoring Protocol within 150 calendar days after approval of the SUD demonstration. The SUD Monitoring Protocol must be developed in cooperation with CMS and is subject to CMS approval. Once approved, the SUD Monitoring Protocol will be incorporated into the STCs, as Attachment CC. At a minimum, the SUD Monitoring Protocol must include reporting relevant to each of the program implementation areas listed in STC 89(a). The SUD Monitoring Protocol must specify the methods of data collection and timeframes for reporting on the state's progress on required measures as part of the general reporting requirements described in Section XX of the demonstration. In addition, the SUD Monitoring Protocol must identify a baseline and a target to be achieved by the end of the demonstration. Where possible, baselines will be informed by state data, and targets will be benchmarked against performance in best practice settings. CMS will closely monitor demonstration spending on services in IMDs to ensure adherence to budget neutrality requirements. Progress on the performance measures identified in the Monitoring Protocol will be reported via the quarterly and annual monitoring reports.

- c. **Mid-Point Assessment.** The state must conduct an independent mid-point assessment by June 30, 2020. The state must require that the assessor collaborate with key stakeholders, including representatives of MCOs, SUD treatment providers, beneficiaries, and other key partners in the design, planning and conducting of the mid-point assessment. The state must require that the assessment include an examination of progress toward meeting each milestone and timeframe approved in the SUD Implementation Plan, and toward closing the gap between baseline and target each year in performance measures as approved in the SUD Monitoring Protocol. The state must require that the assessment include a determination of factors that affected achievement on the milestones and performance measure gap closure percentage points to date, and a determination of selected factors likely to affect future performance in meeting milestones and targets not yet met and about the risk of possibly missing those milestones and performance targets. The state must require that the mid-point assessment must also provide a status update of budget neutrality requirements. For each milestone or measure target at medium to high risk of not being met, the state must require that the assessor provide, for consideration by the state, recommendations for adjustments in the state's implementation plan or to pertinent factors that the state can influence that will support improvement. The state must require that the assessor provide a report to the state that includes the methodologies used for examining progress and assessing risk, the limitations of the methodologies, its determinations and any recommendations. The state must provide a copy of the report to CMS. The state must brief CMS on the report

For milestones and measure targets at medium to high risk of not being achieved, the state will submit to CMS modifications to the SUD Implementation Plan and SUD Monitoring Protocol for ameliorating these risks subject to CMS approval.

- d. **SUD Evaluation.** The OUD/SUD Evaluation will be subject to the same requirements as the overall demonstration evaluation, as listed in sections XX General Reporting Requirements and XXII Evaluation of the Demonstration of the STCs.
- e. **SUD Evaluation Design.** The draft Evaluation Design must be developed in accordance with Attachment W (Developing the Evaluation Design) of these STCs. The state must submit, for CMS comment and approval, a revision to the Evaluation Design to include the SUD program with implementation timeline, no later than one hundred eighty (180) days after the effective date of these amended STCs. Any modifications to an existing approved Evaluation Design will not affect previously established requirements and timelines for report submission for the demonstration, if applicable. The state must use an independent evaluator to develop the draft Evaluation Design.

- i. Evaluation Design Approval and Updates.** The state must submit a revised draft Evaluation Design within sixty (60) days after receipt of CMS’ comments. Upon CMS approval of the draft Evaluation Design, the document will be included as an attachment to these STCs. Per 42 CFR 431.424(c), the state will publish the approved Evaluation Design within thirty (30) days of CMS approval. The state must implement the evaluation design and submit a description of its evaluation implementation progress in each of the Quarterly and Annual Reports, including any required Rapid Cycle Assessments specified in these STCs. Once CMS approves the evaluation design, if the state wishes to make changes, the state must submit a revised evaluation design to CMS for approval.
 - ii. Evaluation Questions and Hypotheses Specific to OUD/SUD Program.** Consistent with Attachments W and X (Developing the Evaluation Design and Preparing the Evaluation Report) of these STCs, the evaluation documents must include a discussion of the evaluation questions and hypotheses that the state intends to test. Each demonstration component should have at least one evaluation question and hypothesis. The hypothesis testing should include, where possible, assessment of both process and outcome measures. Proposed measures should be selected from nationally-recognized sources and national measures sets, where possible. Measures sets could include CMS’s Core Set of Health Care Quality Measures for Children in Medicaid and CHIP, Consumer Assessment of Health Care Providers and Systems (CAHPS), the Initial Core Set of Health Care Quality Measures for Medicaid-Eligible Adults and/or measures endorsed by National Quality Forum (NQF).
- f. SUD Health Information Technology (Health IT).** The state must provide CMS with an assurance that it has a sufficient health IT infrastructure/“ecosystem” at every appropriate level (i.e. state, delivery system, health plan/MCO and individual provider) to achieve the goals of the demonstration—or it will submit to CMS a plan to develop the infrastructure/capabilities. This “SUD Health IT Plan,” or assurance, will be included as a section of the state’s “Implementation Plan” (see STC 89 (a)) to be approved by CMS. The SUD Health IT Plan will detail the necessary health IT capabilities in place to support beneficiary health outcomes to address the SUD goals of the demonstration. The plan will also be used to identify areas of SUD health IT ecosystem improvement.

 - i.** The SUD Health IT section of the Implementation plan will include implementation milestones and dates for achieving them (see Attachment Z).

- ii. The SUD Health IT Plan must be aligned with the state’s broader State Medicaid Health IT Plan (SMHP) and, if applicable, the state’s Behavioral Health (BH) “Health IT” Plan.
- iii. The SUD Health IT Plan must describe the state’s goals, each DY, to enhance the state’s prescription drug monitoring program’s (PDMP)¹
- iv. The SUD Health IT Plan must address how the state’s PDMP will enhance ease of use for prescribers and other state and federal stakeholders.² This must also include plans to include PDMP interoperability with a statewide, regional or local Health Information Exchange. Additionally, the SUD Health IT Plan will describe ways in which the state will support clinicians in consulting the PDMP prior to prescribing a controlled substance—and reviewing the patients’ history of controlled substance prescriptions—prior to the issuance of a Controlled Substance Schedule II (CSII) opioid prescription.
- v. The SUD Health IT Plan must, as applicable, describe the state’s capabilities to leverage a master patient index (or master data management service, etc.) in support of SUD care delivery. Additionally, the SUD Health IT Plan must describe current and future capabilities regarding PDMP queries—and the state’s ability to properly match patients receiving opioid prescriptions with patients in the PDMP. The state must also indicate current efforts or plans to develop and/or utilize current patient index capability that supports the programmatic objectives of the demonstration.
- vi. The SUD Health IT Plan must describe how the activities described in (a) through (e) above will support broader state and federal efforts to diminish the likelihood of long-term opioid use directly correlated to clinician prescribing patterns.³
- vii. In developing the Health IT Plan, states should use the following resources.
 - 1. States may use resources at Health IT.Gov (<https://www.healthit.gov/playbook/opioid-epidemic-and-health-it/>) in “Section 4: Opioid Epidemic and Health IT.”

¹ Prescription drug monitoring programs (PDMP) are electronic databases that track controlled substance prescriptions in states. PDMPs can provide health authorities timely information about prescribing and patient behaviors that contribute to the “opioid” epidemic and facilitate a nimble and targeted response.

² *Ibid.*

³ Shah, Anuj, Corey Hayes and Bradley Martin. *Characteristics of Initial Prescription Episodes and Likelihood of Long-Term Opioid Use — United States, 2006–2015*. MMWR Morb Mortal Wkly Rep 2017;66.

2. States may also use the CMS 1115 Health IT resources available on “Medicaid Program Alignment with State Systems to Advance HIT, HIE and Interoperability” at <https://www.medicaid.gov/medicaid/data-and-systems/hie/index.html>. States should review the “1115 Health IT Toolkit” for health IT considerations in conducting an assessment and developing their Health IT Plans.
 3. States may request from CMS technical assistance to conduct an assessment and develop plans to ensure they have the specific health IT infrastructure with regards to PDMP plans and, more generally, to meet the goals of the demonstration.
- h. The state must include in its Monitoring Protocol (see STC 89(b)) an approach to monitoring its SUD Health IT Plan which will include performance metrics to be approved in advance by CMS.
 - i. The state must monitor progress, each DY, on the implementation of its SUD Health IT Plan in relationship to its milestones and timelines—and report on its progress to CMS in an addendum to its Annual Reports (see STC 120).
 - j. As applicable, the state should advance the standards identified in the ‘Interoperability Standards Advisory—Best Available Standards and Implementation Specifications’ (ISA) in developing and implementing the state’s SUD Health IT policies and in all related applicable State procurements (e.g., including managed care contracts) that are associated with this demonstration.
 - i. Where there are opportunities at the state- and provider-level (up to and including usage in MCO or ACO participation agreements) to leverage federal funds associated with a standard referenced in 45 CFR 170 Subpart B, the state should use the federally-recognized standards, barring another compelling state interest.
 - ii. Where there are opportunities at the state- and provider-level to leverage federal funds associated with a standard not already referenced in 45 CFR 170 but included in the ISA, the state should use the federally-recognized ISA standards, barring no other compelling state interest.

XVI. RECOVERY NAVIGATION PROGRAM (RNP) SERVICES

The Recovery Navigation Program (RNP) is a non-residential (less than 24 hours), community-based recovery-oriented program that assesses, monitors, and provides case management and peer support for individuals who are under the influence of substances within a less-traumatic, less costly setting than the Emergency Department. These individuals are provided with case management in an attempt to connect them to substance use disorders (SUD) treatment and support services. Medicaid reimbursement for referral services in a RNP is limited

to Medicaid enrolled beneficiaries who receive the services listed in STC 90 and from one of the qualified provider organizations that meet the requirements in STC 91 and 92 for RNP participating providers.

- 91.** On-site Medicaid-coverable RNP services are limited to services provided by a licensed EMT, LPN or RN, and case management services furnished by providers that meet the state’s qualifications for furnishing these services.
- a. RNP services will be provided by RNP practitioners, who may include an on-call physician, Registered Nurse, Licensed Practical Nurse (LPN), Emergency Medical Technician (EMT), and Case Manager practicing at an RNP participating provider defined in STC 91. These services will be within their scope of practice under state law and include services such as assessments and monitoring the health status of the individual at intake and throughout the beneficiary’s participation in the RNP.
 - b. Case management services are provided by a Case Manager. A case manager will have a degree in social work, psychology, or other human service related field from an accredited college or university (there is no state level certification or licensure required). Case managers practicing at an RNP participating provider will receive all required trainings through the RNP participating provider.
 - c. Case management services are limited to identifying services appropriate for the beneficiary and referring the beneficiary to resources to obtain needed services. Referrals to these services may include, but are not necessarily limited to, substance use treatment (including medication assisted treatment, detoxification, crisis stabilization, and residential medical services); social services; and housing support services. These services will not be provided directly under the RNP; rather, case managers participating in the RNP will only link beneficiaries to the services.
 - d. Costs for services provided in an institution for mental disease (IMD) will not be eligible for federal matching funds under the RNP or as a result of a referral made under the RNP.
 - e. RNP participating providers will claim payment for services provided under the RNP based on the RNP Claiming Methodology Protocol. The state must submit this protocol 60 days after the approval of the STCs and CMS has 60 days to approve the protocol. The approved protocol will be Attachment X of these STCs.
 - f. Any provider delivering services through the RNP bundle will be paid through the RNP bundled payment rate and cannot bill separately. Medicaid providers delivering services outside of the RNP service bundle may bill in accordance with the state’s Medicaid billing procedures.

92. RNP participating providers are organizations that do all of the following:

- a. Meet applicable state licensure requirements of the Rhode Island Department of Behavioral Healthcare, Developmental Disabilities and Hospitals (BHDDH) or the Rhode Island Department of Health (DOH) for the relevant provider type;
- b. Meet state certification standards to furnish RNP services as specified on the EOHHS website.
- c. Enter into an agreement with the state that reflects all requirements for furnishing, claiming, and receiving payment for RNP services, including the referral process from EMS and other emergency responders, the monitoring requirements, tracking performance measures and reporting to the BHDDH and EOHHS, as specified in this section XIII of the STCs. The state will ensure that these agreements reflect the RNP providers' agreement to abide by these STCs and all applicable federal and state laws; and
- d. Ensure the on-site presence of all necessary practitioners to implement RNP services including a Registered Nurse, Licensed Practical Nurse, and/or Emergency Medical Technician; a Peer Recovery Specialist; and a Case Manager. These practitioners will operate within the setting established by the RNP participating provider with which they are associated and deliver the RNP services described in STC 90. An on-call physician, will be available to the RNP provider for telephonic consultation as needed.
- e. Administrative staff employed by the RNP participating provider will assist in the support of the program and may include, but are not limited to, a Program Manager, Medical Office Assistant, and Security personnel.

93. The state will ensure that RNP participating providers are required to facilitate and conduct necessary training for their RNP practitioners and staff on the implementation of the RNP. The state will review each RNP participating provider's curriculum to ensure the quality and consistency of the trainings. The standard trainings that the RNP participating provider, practitioners and staff receive include, but is not limited to, the following, as appropriate to the person's role within the RNP:

- a. Trauma-informed care
- b. Screening and Assessments
- c. Substance Use Disorders
- d. Alcohol Use Disorder and its effects including the dangers of detoxification from alcohol
- e. Medication Assisted Treatment

- f. Ethics and Boundaries
- g. Motivational interviewing (MI) (an evidence-based treatment that addresses ambivalence about or resistance to change)
- h. Crisis intervention
- i. CPR- Cardiopulmonary Resuscitation
- j. Community resources
- k. Naloxone administration

94. The RNP is intended to promote a recovery-oriented environment and facilitate access to services to address substance use disorder without other medical complications in adults who meet the following appropriateness criteria:

- a. 18 years of age or older; the state assures that comparable services are available for SUD treatment and referrals for children under 18 years of age who do not meet the range for RNP services.
- b. Eligible for Medicaid or a Medicaid beneficiary;
- c. Have no other immediate medical needs other than substance use;
- d. Do not have any abnormal vital signs, pulse oximetry, or abnormal blood sugar levels; and
- e. Do not have any signs of physical trauma, illness, or environmental emergency.

95. The on-site RN, LPN, or EMT, will use clinical judgment after observation of the individual, and review and analyze of observable (or available) clinical information to determine if the level of impairment warrants a transfer to the emergency department (ED). If the on-site practitioner determines that the individual's medical condition requires emergent medical care, the individual will be transported by EMS to the ED. If the clinical staff determines that the individual does not require emergent medical care but that RNP services are not appropriate for the individual, alternative arrangements and referrals will be made by the RNP case manager.

Individuals will be able to access the RNP through any number of referral sources including, but not limited to, Peer Recovery Specialists, Outreach Workers, community agencies, physicians, family, and self-referrals. The RNP participating providers will establish Memoranda of Agreements (MOAs) with other local medical providers and organizations (including the Rhode Island Department of Health, Center for Emergency Preparedness and Response (CEPR), which coordinates education and support services for public safety agencies and the general public), and will utilize an EOHHS approved standard screening tool, found in Attachment V, to determine if RNP services are appropriate for an individual. These MOAs will include the content described in Attachment U.

96. Individuals may be transported to the RNP participating provider via Emergency Medical Services (EMS) and law enforcement. Prior to transport, the emergency responder will conduct an initial screening to determine if referral to an RNP participating provider for RNP services is appropriate, using the screening tool found in Attachment V.

97. If possible, all referral sources will notify the RNP participating provider of the pending arrival of an individual. Regardless of referral source or prior notification, individuals will be received by clinical staff of the RNP participating provider.

- a. The individual will be brought to the triage area for a full assessment performed by RN, LPN, or EMT, who prioritizes the determination of the state of intoxication, potential for increased intoxication, and risk for withdrawal using the Clinical Institute Withdrawal Assessment (CIWA) and Clinical Opiate Withdrawal Scale (COWS). Vital signs and Blood Alcohol Level (BAL) are also collected. In the event an individual has been transported by an emergency responder, these screenings/assessments are all conducted prior to the emergency responder leaving the RNP participating provider's site. This is to ensure that the individual is served in the clinically appropriate setting.
- b. Once RNP services are determined to be appropriate for the individual by clinical staff, ongoing assessments of vital signs, BAL, COWS, and CIWA, will be conducted as appropriate. The RNP participating provider will use the Patient Health Questionnaire-9 (PHQ-9) to document any concerns of depression, and/or thoughts of harming oneself.
- c. Any non-emergent mental health issue that may be identified by the RNP participating provider would be addressed through the RNP referral process for additional assistance. The presence of peripheral mental health issues does not exclude participants so long as they meet the appropriateness criteria for RNP services.

98. Requirements Related to Program Monitoring:

- a. The RNP participating provider shall provide BHDDH and EOHHS with information needed to monitor compliance, quality improvement, and effective clinical care.
- b. The RNP participating provider shall provide BHDDH and EOHHS with an outcome-oriented quarterly progress report, in addition to meeting the performance measure reporting requirements, as detailed below in STC 103(e).
- c. The RNP participating provider shall meet with BHDDH and EOHHS personnel to discuss operational and policy matters related to any services

provided under the RNP participating provider agreement including, but not limited to, performance on issues of access, continuity of care, and development and implementation of the RNP.

- d. Any requested amendments to the RNP participating provider agreement, and any contracts related to the provider's participation in the RNP (including with respect to the services agreed to be provided by the RNP participating provider and/or by any contractor of the RNP participating provider), must be submitted in writing to BHDDH and EOHHS for review and approval prior to implementation. EOHHS must submit requested changes to the permissible RNP services identified in STC 90 to CMS and must receive CMS approval before any such changes are implemented within the RNP.
- e. Prior to releasing the individual, the RNP participating provider must attempt to collect client feedback from the individual to help ensure quality of services in the form of a consumer satisfaction survey.
- f. The RNP participating provider (and, if applicable, any contractors of the RNP participating provider), must maintain a detailed, comprehensive record of all services provided under the program.
 - g. The RNP participating provider must provide at least two hours per month or 30 minutes per week of documented supervision to all Case Managers, administered by an appropriately licensed healthcare professional. The RNP provider must adhere to all applicable Rhode Island General Laws and Code of Regulations regarding supervision of on-call physician, Registered Nurses, Licensed Practical Nurses (LPN), and Emergency Medical Technicians (EMT).

99. Performance Measures for Recovery Navigation Program

The RNP participating provider is required to submit data at monthly intervals to BHDDH and EOHHS via secure electronic files of client-level records for all individuals receiving RNP services, as outlined in STC 90.

- a. The RNP participating provider monthly reporting will include the minimum requirements below and submitted in the format required by the state:
 - i. Number of unduplicated clients served;
 - ii. Number of Medicaid beneficiaries assessed for RNP admission;
 - iii. Number of individuals eligible for Medicaid but not an enrolled Medicaid beneficiary at the time of RNP service assessed for specific RNP services during reporting period (reporting should be done per RNP service); For each client, date and time of entry into the program;
 - iv. Number of clients that upon assessment with RNP, self-reported a mental health issue or co-occurring disorders;

- v. Number of clients with self-reported current medical conditions;
 - vi. Patient demographics (SSN, age, gender, ethnicity, city of residency);
 - vii. Historical substance(s) used;
 - viii. Number of clients referred for additional services, including detoxification or crisis stabilization unit (reporting should be done per referral service)
 - ix. Number of clients that continue to work with the peer recovery support team, 3, 6 and 12 months after referral;
 - x. Number of clients sent to the ED from RNP because of an RNP practitioner determination that ED services were clinically required;
 - xi. Source of referral to RNP (EMS, self-referral, police, Peer Recovery Specialists, ED, other hospital department, etc., with number of referrals reported by source);
 - xii. Number of clients referred for application to other social/health/human services benefit programs, such as Low Income Heat Energy Assistance Program (LIHEAP), Medicaid (if not an enrolled beneficiary), Rhode Island Rite Care (SCHIP) Benefits, Women, Infants and Children Program (WIC), Supplemental Nutrition Assistance Program (SNAP), Unemployment, RI Works.
 - xiii. The RNP participating provider shall provide quarterly progress report narratives including any obstacles to successful implementation of the RNP and steps taken or planned to address such obstacles, which narratives shall be informed by client feedback regarding quality of services. This data will be crossed with Medicaid claims data and Behavioral Health On- Line Database of admission, discharge and outcome data to determine if the total cost of care for individuals receiving interventions under the RNP is reduced or increased, if hospital admissions are decreased, and if they make inroads to recovery through engagement in treatment, increased stability in housing, reduction in substance use and other outcome measures as collected through the Substance Abuse and Mental Health Services Administration's (SAMHSA) National Outcome measures.
- b. The state should provide a summary of this information in its annual monitoring reports.

XVII. PEER RECOVERY SPECIALIST (PRS) AND FAMILY/ YOUTH SUPPORT PARTNERS (FYSP) PROGRAMS

- 100.** The Peer Recovery and Family Youth Support Peer Program will have a Peer Recovery Specialist (PRS) or Family/Youth Partners (FYSP) work with a beneficiary to offer a unique vantage point and the skills of someone who has succeeded in managing a serious behavioral health condition or developmental disability, or is an adult with an on-going and/or personal experience caring for a child or with another family member with a similar mental illness and/or substance use disorder. The key objective of this program is to provide individuals with a support system to develop and learn healthy living skills.
- 101.** Recovery support services are expected to help prevent relapse, reduce the severity of a disability, improve and restore function and promote long-term recovery. Additionally, FYSPs act to prevent hospitalization or short- or long-term residential treatment that results from a child's (under age 21) behavioral health condition. Recovery support services include peer support to foster encouragement of personal responsibility and self-determination, tools and education to focus on health and wellness and skills to engage and communicate with providers and systems of care. These peer supports will assist, educate and encourage the participant and their family members to be active advocates for services to secure healthier outcomes for the participant.

The Peer Recovery Specialists (PRS) offer peer services that focus on people with a mental health and/or substance use disorder who are having trouble stabilizing in the community and/or are in need of supports to maintain their stability in the community. This includes but is not limited to Medicaid-eligible individuals who are experiencing, or are at risk of, hospitalization, overdose, homelessness or are in the hospital after an overdose, are homeless or are in a detox setting. It also includes people recently released from institutions such as hospitals and prison.

The FYSP offers services to children under 21 years of age and their caregivers related to supporting a child with behavioral health needs and to improve functioning within family and community settings. The services focus on stabilizing the child with behavioral health or developmental disability disorder to promote well-being of the child and limiting the effects of various social determinants. The goal is for the child to continue to be living in the community with services rather than being institutionalized in a short- or long- term residential treatment facility or hospital.

- 102.** The PRS and FYSP role is to bring to the beneficiary a unique vantage point and the skills of someone who has succeeded in managing a serious behavioral health condition or developmental disability, or is an adult with an on-going

and/or personal experience caring for a child or with another family member with a similar mental illness and/or substance use disorder. The key objective of this position is to provide individuals with a support system to develop and learn healthy living skills. Recovery support services are expected to help prevent relapse, reduce the severity of a disability, improve and restore function and promote long-term recovery. Additionally, FYSPs act to prevent hospitalization or short- or long-term residential treatment that results from a child's behavioral health condition. Services include peer support to foster encouragement of personal responsibility and self-determination, tools and education to focus on health and wellness and skills to engage and communicate with providers and systems of care. These peer supports will assist, educate and encourage the participant and their family members to be active advocates for services to secure healthier outcomes for the participant.

The state must require that the PRS or FYSP work under the direction of a licensed health care practitioner. The Peer Recovery Specialist may also work under the direction of or a non-clinical PRS Supervisor. Non-clinical PRS Supervisors must be certified as a PRS and have worked at least 2 years providing PRS services. A Peer Recovery Specialist may work under the supervision of a RNP participating provider. Peer Recovery Specialist services that are provided through the RNP will be paid through the RNP bundled payment rate and may not be separately billed. Peer Recovery Specialist services that are not provided through the RNP must be billed by a Medicaid-enrolled provider of services through standard claiming procedures, and will be paid a flat fee for all services provided to a given Medicaid beneficiary. The FYSP specifically, will work under the direction and specifications from the Department of Children, Youth and Family (DCYF). Although children and caregivers may be involved with DCYF, the Family/Youth Support Partner service focuses upon mitigating a behavioral health condition defined through the current version of the Diagnostic and Statistical Manual of Mental Disorders (DSM). In addition to providing wellness supports, the PRS/FYSP utilizes his or her own experiences to act as a role model, teacher, and guide who both encourages and empowers the beneficiary to succeed in recovery and leading a healthy productive lifestyle.

103. Benefits. Specific other examples of PRS and FYSP work include, but are not limited to, the following:

- a. Supporting individuals in accessing community-based resources; recovery, health and wellness supports; and employment services;
- b. Guiding individuals in developing and implementing recovery, health and wellness, and employment plans. Serving as a role model for the integration of recovery, health and wellness, and employment;

- c. Educating individuals regarding services and benefits available to assist in transitioning into and staying in the workforce;
- d. Navigating state and local systems (including addiction and mental health treatment systems);
- e. Using lived experience to help youth and their caregivers to understand and develop the skills to address behavioral health conditions within a family and community setting
- f. Mentoring individuals as they develop strong foundations in recovery and wellness;
- g. Promoting empowerment and a sense of hope through self-advocacy by sharing personal recovery experiences;
- h. Serving as an integral member of an individual’s recovery and wellness team.

104. Peer Recovery Specialist/Family/Youth Support Partner. The state must require a Peer Recovery Specialist/Family/Youth Support Partner must meet the following criteria:

- a. Credentialed by the Rhode Island Certification Board (RICB) as a Peer Recovery Specialist, pursuant to the standards available at <http://www.ricertboard.org/>. RICB credentialing standards meet minimum standards of the International Certification and Reciprocity Consortium (IC&RC). Family/Youth Support Partners will be certified by the RICB or by DCYF.
- b. Peer support services will be provided by a Peer Recovery Specialist and include group and individual coaching, and education on the recovery process. Peer Recovery Specialists must meet the qualifications in the CMS State Medicaid Director Letter, #07-011, <https://www.medicaid.gov/Federal-Policy-Guidance/downloads/SMD081507A.pdf>.
- c. Acknowledges s/he has a mental illness, addiction, chronic illness, or intellectual/developmental disability (ID/DD) and has received or is currently receiving treatment and/or community support for it. People who have experience with an on-going and/or personal experience with a family member, including their child, with a similar mental illness and/or substance use disorder are also qualified to be a PRS.
- d. The service is restorative in nature for individuals with mental health and/or substance use disorders needing support to maintain stability in the community. PRS operate under a “Recovery Oriented Systems of Care” model. They use a strengths-based approach with the primary goal being to assist individuals in achieving sustained recovery and restoration.
- e. Reporting and Monitoring. Consumer Surveys as well as focus groups and outreach in the community will be used to collect information about the

effectiveness of the PRS. The Consumer Survey is administered to identified potential clients during the first contact, and then at 6 months and 1 year. BHDDH, through a contract with a local community agency, will be doing outreach to and focus groups for populations with additional challenges including but not limited to: housing instability; socioeconomic status; employment issues; people transitioning from prison to community; those with transportation issues; and parents involved with child welfare system to get their input regarding peer recovery services. Information gleaned from the focus groups, surveys, and outreach will be used to improve PRS training and service delivery. Similarly, DCYF will be administering consumer surveys for Family/Youth Partner service recipients.

- f. The Peer Recovery Specialist Training Curriculum must meet the Rhode Island Certification Board standards.

XVIII. Behavioral Health Link (BH Link) Program

105. The Behavioral Health Link (BH Link) program will begin in the first quarter of January 2019 as one triage center to support crisis stabilization and short-term treatment for Medicaid beneficiaries experiencing a behavioral health (mental health and/or substance use disorder) crisis. This triage center must provide access to a specialized emergency behavioral healthcare services other than emergency departments. As of January 2019, there is only one provider that can receive reimbursement for this service, which will operate 24 hours a day, 7 days a week. The state may implement this program on a less than statewide basis. If the state finds this program is found to be cost effective, the state will increase the number of BH Link triage centers.

106. The BH Link is a licensed behavioral healthcare facility that will provide services consistent with a licensed community mental health center. Physician- or nurse-approved protocols for the provision of emergency medical and emergency behavioral healthcare will be available for staff at the center as needed.

107. The BH Link triage center will provide screening/evaluations, treatment, crisis intervention—including local mobile outreach, case management, assessment, treatment coordination, 23-hour observation beds, discharge planning, warm hand-offs to community providers, and medications. Attachment BB contains the component services that are provided through the BH Link.

108. The BH Link triage center will provide services to include physician services, medication prescribing and management, skilled nursing, behavioral

health services provided by qualified Mental Health Professionals, comprehensive assessment and triage, crisis stabilization and management, behavioral disorder evaluations, treatment identification and facilitation, system navigation, case management, engagement and follow-up care post initial assessment, and discharge coordination. All of these services will be available on site directly from staff 24/7 or through telemedicine. In addition, staff from the triage center who respond to crises in the community through a mobile intervention, will have access to all triage staff.

The state must require that a BH Link and its staff meet EOHHS certification standards that will address minimal staffing levels, availability (e.g., must be open 24 hours per day, 7 days per week), the protocols for referral and warm handoffs to other treatment resources, and affiliation with the BH Link hotline.

- 109.** The BH Link triage center will receive a bundled rate that may be billed no more than once per client per 24-hour period. The bundled rate will include physician services, medication prescribing and management, skilled nursing, behavioral health services provided by qualified Mental Health Professionals, comprehensive assessment and triage, crisis stabilization and management, behavioral disorder evaluations, treatment identification and facilitation, system navigation, case management, engagement and follow-up care post initial assessment, and discharge coordination. The state must submit the bundled rate methodology no later than 120 days prior to implementation. The methodology will be incorporated as Attachment CC of the STCs.

XIX. Telephonic Psychiatric Consultation Services

110. Telephonic Psychiatric Consultation Services

a. General Description

Under the Telephonic Psychiatric Consultation Services, the state receives FFP for telephonic consultations by psychiatrists provided to primary care providers (PCP), including physicians, physician assistants, nurse practitioners, and obstetricians and gynecologists (OBGYNs), that need consultative assistance regarding a Medicaid eligible child or adult with potential behavioral and/or mental health conditions. The telephonic psychiatric consultations will be a discussion between the PCP and a psychiatrist or licensed behavioral health provider with similar prescribing authority without the beneficiary being present. Beneficiaries will not be

charged any cost-sharing as a result of the telephonic psychiatric consultation service. Beneficiaries will have advance notice and the opportunity to consent or not consent before the telephonic psychiatric consultation occurs.

b. Service Description

The consultation services provided to the PCP by the psychiatrist or licensed behavioral health provider with similar prescribing authority include:

1. Diagnostic clarification
2. Treatment planning
3. Second opinion
4. Screening support
5. Crisis consultation
6. Care Plan Development – recommending appropriate resources and additional referrals
7. Pharmacological support – side effects, selection, dosage, medication management etc.
8. Referral Assistance

For some cases, in-person consultation between all parties and/or beneficiary follow-up with a psychiatrist via referral may be appropriate.

c. Payment Methodology

The state will pay a flat fee for each individual consultative service provided, directly to the billing psychiatrist, of \$54.70, for 21-30 minutes of medical consultative discussion and review for the first year of implementation. Each year, beginning DY13, the unit cost may increase by one percent.

d. Evaluation: Pursuant to STC 127, the state is required to submit a revised evaluation design for CMS approval after the approval of the amendment. The state must update its evaluation design 180 days after the Amendment approval date for these services to examine the effectiveness of the telephonic psychiatric consultation services. The revised evaluation design should include, but is not limited to, the following process and health outcome measures 1-5 below, and also should include, but is not limited to, either the process and health outcome measures 6-11 below or other similar or comparable measures.

1. Type and amount of behavioral health services provided within the primary care practice
2. Geographic location of each primary care practice that utilized these services

3. Number of utilizing primary care providers who found that this service was helpful and increased their sense of confidence in providing behavioral health services to beneficiaries
4. Number of children and adults served
5. Number of primary care practitioners accessing the program's services
6. Follow-Up after Hospitalization for Mental Illness – 7 Day (NQF #576);
7. Antidepressant Medication Management (NQF #0105);
8. Adherence to Antipsychotic Medications for Individuals with Schizophrenia (MIPS #383);
9. Initiation & Engagement of Alcohol & Other Drug Dependence Treatment (NQF #0004);
10. Screening for Clinical Depression and Follow-Up Plan (MIPS #134);
11. Maternal Depression Screening (CMS #82).

e. Monitoring. The state must include updates regarding the telephonic psychiatric consultation services in its quarterly reports as required in STC 120. The state's quarterly reports must include narrative information that will give information on the following aspects: how the program is supporting quality of care, improving health outcomes, and any costs/benefits for this specific health care intervention. The broad outcomes to be achieved include: increased availability of psychiatric and behavioral health services within the scope of primary care practices; promotion of a strong primary care/specialist relationship; and rational use of scarce resources. The confidence of participating PCPs to treat psychiatric and behavioral health issues within their scope of practice will be used as a key indicator.

XX. Dental Case Management (DCM) Pilot

111. The Dental Case Management (DCM) Pilot uses a select group of trained dental practices across the state. The DCM Pilot focuses on using four new dental case management service codes to emphasize health care coordination, improve oral health literacy and to support patient compliance among Medicaid beneficiaries. The state may implement this pilot less than statewide, and the state will select up to six (6) dental practices. The state must require that the dental practices complete a no-cost training program developed in partnership with the Medicaid/Medicare CHIP Services Dental Association (MSDA) and submit verification documentation showing completion of the training to the state to be part of the DCM pilot. Once selected, dental practices will be able to bill and be reimbursed for four (4) new dental case management CDT codes. The pilot project will phase-in the

new dental case management codes into the state's standard Medicaid oral health policies while continuing to monitor utilization, patient outcomes, and fiscal feasibility. The state will conduct this pilot program for 12 months and may extend the pilot program by seeking and receiving approval from CMS.

- 112.** Dental case management reimbursement will only be available for services provided for adults enrolled in fee-for-service. Under the pilot, the dental practice may bill the following codes: addressing appointment compliance barriers (D9991), care coordination (D9992), motivational interviewing (D9993), and patient education to improve oral health literacy (D9994). Dental practices will receive fee-for-service (FFS) payment for completion of dental case management services. For participating practices that are also Federally Qualified Health Centers (FQHC), the practices will receive their usual prospective payment when a case management service is billed to the state with another covered dental service. However, if a case management service is provided by an FQHC via phone, as would be appropriate for at least one of the service codes, then the state will reimburse the FQHC for the service on a fee-for-service basis. The provider will receive \$22 for each code billed.
- 113.** The Providers Dental practices participating in the pilot must complete a no-cost online training program developed in partnership with the Medicaid/Medicare CHIP Services Dental Association (MSDA) and submit verification documentation to be a part of the pilot. Training and verification information will be posted by state.
- 114.** For providers to receive reimbursement for the DCM services, the state must require that the following requirements must be completed:
- a. Completion of an online or paper DCM Progress and Outcomes Data Collection Form;
 - b. Submission to EOHHS, documenting progress around the patient's behavior; and
 - c. Scores which grade the degree of behavior difficulty must be provided and resubmitted at follow-up to assess progress.
- 115.** The state must collect data and report on the following performance measures, stratified by case management code, by provider, by provider type and totals:
- a. Number of, and percentage change in, broken appointments among adult beneficiaries, to be indicated on the Dental Case Management Progress and Outcomes Data Collection Form;
 - b. Number of, and percentage change in, preventive dental services;
 - c. Ratio of preventive dental services to restorative services provided
 - d. Number of and percentage of completed treatment plans;

- e. Change in utilization of emergency rooms for dental-related reasons among the targeted population (use of the ER for dental trauma will be excluded from this analysis if a claims-based methodology for doing so is identified); and
- f. Aggregated scores and improvements focused on:
- g. Health literacy (patient-reported outcomes - physiological, psychosocial and functional oral health);
- h. Patient experience with health care (access to care, transportation needs, community-based needs, coordination of specialty healthcare needs, cultural competency, cost, and shared decision-making)

The state must also track and report on the utilization of Dental Case Management service to monitor utilization by provider, provider type, age, and sex of the beneficiary.

- a. State Oversight, Monitoring, and Reporting
- b. Program Integrity: To ensure program integrity, the state must perform annual assessments of service utilization, billing patterns and costs that may be indicators of fraud, waste or abuse. The state is required to ensure all claims submitted for adjudication are handled in a timely manner. Any suspicious claim activity is tracked through the program's MMIS to prevent fraud and abuse.
- c. Monitoring Protocol/Provisions: The state must track and analyze Dental case management code activity in MMIS on a regular basis through the State's fiscal intermediary, DXC. In addition, a Dental Case Management *Progress and Outcomes Data Collection Form* must be monitored and analyzed for each dental case management service by adult patient. These forms will be instrumental in determining a patient's progress. Data from the *Progress and Outcomes Data Collection Form* will be housed in a separate database to allow relevant analytics to occur regularly.

The outcomes of the Dental Case Management pilot will be used to determine whether there are positive behavior changes from the delivery of dental case management services to adult beneficiaries in a dental practice setting. From ongoing analysis of data over the pilot period, the state anticipates there will be demonstrated positive outcomes around two critical assessment areas that link to long-lasting healthy behaviors.

- 116.** The state must report to CMS on an annual basis in the demonstration annual report, per the requirements in STC 120. The annual report must include the DCM Pilot summary and must include the following:
- a. A descriptive assessment of the impact of dental case management

services, based on the results of the performance metrics as described above.

- b. A discussion of the extent to which the metrics described for this pilot are proving to be useful in understanding the effectiveness of the DCM Pilot;
- c. An analysis of changes in cost per adult;
- d. A descriptive analysis of any challenges generated by this pilot and how those challenges have been, or will be, addressed

XX. GENERAL REPORTING REQUIREMENTS

117. Submission of Post-Approval Deliverables. The state must submit all deliverables as stipulated by CMS and within the timeframes outlined within these STCs.

118. Deferral for Failure to Submit Timely Demonstration Deliverables. CMS may issue deferrals in the amount of \$5,000,000 (federal share) when items required by these STCs (e.g., required data elements, analyses, reports, design documents, presentations, and other items specified in these STCs (hereafter singly or collectively referred to as “deliverable(s)”) are not submitted timely to CMS or found to not be consistent with the requirements approved by CMS. Specifically:

- e. Thirty (30) calendar days after the deliverable was due, CMS will issue a written notification to the state providing advance notification of a pending deferral for late or non-compliant submissions of required deliverables.
- f. For each deliverable, the state may submit a written request for an extension to submit the required deliverable. Extension requests that extend beyond the current fiscal quarter must include a Corrective Action Plan (CAP).
 - i. CMS may decline the extension request.
 - ii. Should CMS agree in writing to the state’s request, a corresponding extension of the deferral process described below can be provided.
 - iii. If the state’s request for an extension includes a CAP, CMS may agree to or further negotiate the CAP as an interim step before applying the deferral.
- g. The deferral would be issued against the next quarterly expenditure report following the written deferral notification.
- h. When the state submits the overdue deliverable(s) that are accepted by CMS, the deferral(s) will be released.
- i. As the purpose of a section 1115 demonstration is to test new methods of operation or services, a state’s failure to submit all required deliverables may

preclude a state from renewing a demonstration or obtaining a new demonstration.

- j. CMS will consider with the state an alternative set of operational steps for implementing the intended deferral to align the process with the state's existing deferral process, for example, what quarter the deferral applies to and how the deferral is released.

119. Deferral of Federal Financial Participation (FFP) from IMD claiming for Insufficient Progress Toward Milestones. Up to \$5,000,000 in FFP for services in IMDs may be deferred if the state is not making adequate progress on meeting the milestones and goals as evidenced by reporting on the milestones in the Implementation Protocol and the required performance measures in the Monitoring Protocol agreed upon by the state and CMS. Once CMS determines the state has not made adequate progress, up to \$5,000,000 in FFP for services in IMDs will be deferred in the next calendar quarter and each calendar quarter thereafter until CMS has determined sufficient progress has been made.

120. Compliance with Federal Systems Updates. As federal systems continue to evolve and incorporate additional 1115 demonstration reporting and analytics functions, the state will work with CMS to:

- k. Revise the reporting templates and submission processes to accommodate timely compliance with the requirements of the new systems;
- l. Ensure all 1115, T-MSIS, and other data elements that have been agreed to for reporting and analytics are provided by the state; and

Submit deliverables to the appropriate system as directed by CMS.

121. Cooperation with Federal Evaluators. As required under 42 CFR 431.420(f), the state must cooperate fully and timely with CMS and its contractors' in any federal evaluation of the demonstration or any component of the demonstration. This includes, but is not limited to, commenting on design and other federal evaluation documents and providing data and analytic files to CMS, including entering into a data use agreement that explains how the data and data files will be exchanged, and providing a technical point of contact to support specification of the data and files to be disclosed, as well as relevant data dictionaries and record layouts. The state must include in its contracts with entities who collect, produce or maintain data and files for the demonstration, that they must make such data available for the federal evaluation as is required under 42 CFR 431.420(f) to support federal evaluation. The state may claim administrative match for these activities. Failure to comply with this STC may result in a deferral being issued as outlined in STC 116.

XXI. MONITORING

122. Monitoring Reports. The state must submit three (3) Quarterly Reports and one (1) compiled Annual Report each DY. The information for the fourth quarter should be reported as distinct information within the Annual Report. The Quarterly Reports are due no later than sixty (60) calendar days following the end of each demonstration quarter. The compiled Annual Report is due no later than ninety (90) calendar days following the end of the DY. The reports will include all required elements as per 42 CFR 431.428, and should not direct readers to links outside the report. Additional links not referenced in the document may be listed in a Reference/Bibliography section. The Monitoring Reports must follow the framework provided by CMS, which is subject to change as monitoring systems are developed/evolve, and be provided in a structured manner that supports federal tracking and analysis.

- a. Operational Updates - Per 42 CFR 431.428, the Monitoring Reports must document any policy or administrative difficulties in operating the demonstration. The reports shall provide sufficient information to document key challenges, underlying causes of challenges, how challenges are being addressed, as well as key achievements and to what conditions and efforts successes can be attributed. The discussion should also include any issues or complaints identified by beneficiaries; lawsuits or legal actions; unusual or unanticipated trends; legislative updates; and descriptions of any public forums held. The Monitoring Report should also include a summary of all public comments received through post-award public forums regarding the progress of the demonstration.
- b. Performance Metrics – Per 42 CFR 431.428, the Monitoring Reports must document the impact of the demonstration in providing insurance coverage to beneficiaries and the uninsured population, as well as outcomes of care, quality and cost of care, and access to care. This may also include the results of beneficiary satisfaction surveys, if conducted, grievances and appeals. The required monitoring and performance metrics must be included in writing in the Monitoring Reports, and will follow the framework provided by CMS to support federal tracking and analysis.
- c. Budget Neutrality and Financial Reporting Requirements Per 42 CFR 431.428, the Monitoring Reports must document the financial performance of the demonstration. The state must provide an updated budget neutrality workbook with every Monitoring Report that meets all the reporting requirements for monitoring budget neutrality set forth in the General Financial Requirements section of these STCs, including the submission of corrected budget neutrality data upon request. In addition, the state must report quarterly and annual expenditures associated with the populations

affected by this demonstration on the Form CMS-64. Administrative costs should be reported separately.

- d. Evaluation Activities and Interim Findings. Per 42 CFR 431.428, the Monitoring Reports must document any results of the demonstration to date per the evaluation hypotheses. Additionally, the state shall include a summary of the progress of evaluation activities, including key milestones accomplished, as well as challenges encountered and how they were addressed.
- e. SUD Health IT. The state will include a summary of progress made in regards to SUD Health IT requirements outlined in STC 89.

123. Corrective Action. If monitoring indicates that demonstration features are not likely to assist in promoting the objectives of Medicaid, CMS reserves the right to require the state to submit a correction action plan to CMS for approval. This may be an interim step to withdrawing waivers or expenditure authorities, as outlined in STC 13.

124. Close-Out Operational Report. Within 120 calendar days after the expiration of the demonstration, the state must submit a Draft Close-Out Report to CMS for comments.

- a. The draft close-out report must comply with the most current Guidance from CMS.
- b. The state will present to and participate in a discussion with CMS on the close-out report.
- c. The state must take into consideration CMS' comments for incorporation into the final close-out report.
- d. The final close-out report is due to CMS no later than 30 calendar days after receipt of CMS' comments.
- e. A delay in submitting the draft or final version of the close-out report may subject the state to penalties described in STC 116.

125. Monitoring Calls. CMS will convene periodic conference calls with the state.

- a. The purpose of these calls is to discuss any significant actual or anticipated developments affecting the demonstration. Examples include implementation activities, enrollment and access, budget neutrality, and progress on the evaluation.
- b. CMS will provide updates on any amendments or concept papers under review, as well as federal policies and issues that may affect any aspect of the demonstration.

c. The state and CMS will jointly develop the agenda for the calls.

- 126. Post Award Forum.** Pursuant to 42 CFR 431.420(c), within six (6) months of the demonstration’s implementation, and annually thereafter, the state must afford the public with an opportunity to provide meaningful comment on the progress of the demonstration. At least 30 calendar days prior to the date of the planned public forum, the state must publish the date, time and location of the forum in a prominent location on its website. The state must also post the most recent annual report on its website with the public forum announcement. Pursuant to 42 CFR 431.420(c), the state must include a summary of the comments in the Monitoring Report associated with the quarter in which the forum was held, as well as in its compiled Annual Report.

XXII. EVALUATION OF THE DEMONSTRATION

- 127. Independent Evaluator.** Upon approval of the demonstration, the state must begin to arrange with an independent party to conduct an evaluation of the demonstration to ensure that the necessary data is collected at the level of detail needed to research the approved hypotheses. The independent party must sign an agreement to conduct the demonstration evaluation in an independent manner in accord with the CMS-approved, draft Evaluation Design. When conducting analyses and developing the evaluation reports, every effort should be made to follow the approved methodology. However, the state may request, and CMS may agree to, changes in the methodology in appropriate circumstances.
- 128. Evaluation Budget.** A budget for the evaluation must be provided with the draft Evaluation Design. It will include the total estimated cost, as well as a breakdown of estimated staff, administrative and other costs for all aspects of the evaluation such as any survey and measurement development, quantitative and qualitative data collection and cleaning, analyses and report generation. A justification of the costs may be required by CMS if the estimates provided do not appear to sufficiently cover the costs of the design or if CMS finds that the design is not sufficiently developed, or if the estimates appear to be excessive.
- 129. Draft Evaluation Design.** The draft Evaluation Design must be developed in accordance with Attachment W (Developing the Evaluation Design) of these STCs. The state may choose to submit one evaluation design inclusive of the demonstration and SUD, or a separate evaluation design focused on SUD. If the state chooses to submit two evaluation designs, the SUD evaluation design is subject to the same terms and conditions listed below which apply to the overall demonstration evaluation. The state must submit, for CMS comment and approval, a draft Evaluation Design with implementation timeline, no later than one hundred eighty (180) days after the effective date of these STCs. Any modifications to an existing approved Evaluation Design will not affect previously established requirements and timelines for report submission for the demonstration, if applicable.

- 130. Evaluation Design Approval and Updates.** The state must submit a revised draft Evaluation Design within sixty (60) days after receipt of CMS' comments. Upon CMS approval of the draft Evaluation Design, the document will be included as an attachment to these STCs. Per 42 CFR 431.424(c), the state will publish the approved Evaluation Design to the state's website within thirty (30) days of CMS approval. The state must implement the evaluation design and submit a description of its evaluation implementation progress in each of the Monitoring Reports, including any required Rapid Cycle Assessments specified in these STCs. Once CMS approves the evaluation design, if the state wishes to make changes, the state must submit a revised evaluation design to CMS for approval.
- 131. Evaluation Questions and Hypotheses.** Consistent with attachments W and X (Developing the Evaluation Design and Preparing the Evaluation Report) of these STCs, the evaluation documents must include a discussion of the evaluation questions and hypotheses that the state intends to test. Each demonstration component should have at least one evaluation question and hypothesis. The hypothesis testing should include, where possible, assessment of both process and outcome measures. Proposed measures should be selected from nationally-recognized sources and national measures sets, where possible. Measures sets may include CMS's Core Set of Health Care Quality Measures for Children in Medicaid and CHIP, Consumer Assessment of Health Care Providers and Systems (CAHPS), the Initial Core Set of Health Care Quality Measures for Medicaid-Eligible Adults and/or measures endorsed by National Quality Forum (NQF).
- 132. Interim Evaluation Report.** As outlined in 42 CFR 431.412(c)(2)(vi), the state must submit an Interim Evaluation Report for the completed years of the demonstration, and for each subsequent renewal or extension of the demonstration. When submitting an application for renewal, the Evaluation Report should be posted to the state's website with the application for public comment.
- a. The interim evaluation report will discuss evaluation progress and present findings to date as per the approved evaluation design.
 - b. For demonstration authority that expires prior to the overall demonstration's expiration date, the Interim Evaluation Report must include an evaluation of the authority that is expiring as approved by CMS.
 - c. If the state is seeking to renew or extend the demonstration, the draft Interim Evaluation Report is due when the application for renewal is submitted. If the state made changes to the demonstration in its application for renewal, the research questions and hypotheses, and how the design was adapted should be included. If the state is not requesting a renewal for a demonstration, an Interim Evaluation report is due one (1) year prior to the end of the demonstration. For demonstration phase outs prior to the expiration of the approval period, the draft Interim Evaluation Report is due to CMS on the date that will be specified in the notice of termination or suspension.

- d. The state must submit the final version of the Interim Evaluation Report 60 calendar days after receiving CMS comments on the draft Interim Evaluation Report and post the document to the state’s website.
- e. The Interim Evaluation Report must comply with Attachment X of these STCs.

133. Summative Evaluation Report. The draft Summative Evaluation Report must be developed in accordance with Attachment X of these STCs. The state must submit a draft Summative Evaluation Report for the demonstration’s current approval period, January 1, 2019 through December 31, 2023, within 18 months of the end of the approval period represented by these STCs. The Summative Evaluation Report must include the information in the approved Evaluation Design.

- a. Unless otherwise agreed upon in writing by CMS, the state must submit the final Summative Evaluation Report within 60 calendar days of receiving comments from CMS on the draft.
- b. The final Summative Evaluation Report must be posted to the state’s Medicaid website within 30 calendar days of approval by CMS.

134. Corrective Action Plan Related to Evaluation. If evaluation findings indicate that demonstration features are not likely to assist in promoting the objectives of Medicaid, CMS reserves the right to require the state to submit a corrective action plan to CMS for approval. These discussions may also occur as part of a renewal process when associated with the state’s Interim Evaluation Report. This may be an interim step to withdrawing waivers or expenditure authorities, as outlined in STC 13.

135. State Presentations for CMS. CMS reserves the right to request that the state present and participate in a discussion with CMS on the Evaluation Design, the interim evaluation, and/or the summative evaluation.

136. Public Access. The state shall post the final documents (e.g., Monitoring Reports, Close Out Report, approved Evaluation Design, Interim Evaluation Report, and Summative Evaluation Report) on the state’s Medicaid website within 30 days of approval by CMS.

137. Additional Publications and Presentations. For a period of twelve (12) months following CMS approval of the final reports, CMS will be notified prior to presentation of these reports or their findings, including in related publications (including, for example, journal articles), by the state, contractor, or any other third party directly connected to the demonstration. Prior to release of these reports, articles or other publications, CMS will be provided a copy including any associated press materials. CMS will be given ten (10) business days to review and comment on publications before they are released. CMS may choose to decline to comment or review some or all of these notifications and reviews. This requirement does not apply to the release or presentation of these materials to state or local government officials.

138. As a part of the Annual reports for Demonstration Years 11 and 12 the state must collect and report data on the tracking of the following items for the Workforce Development DSHP project. Per Attachment R, tracking and reporting will include:
- Number of graduates of each health professional training program for which FFP is claimed, within University of Rhode Island, Rhode Island College and the Community College of Rhode Island
 - Number of Graduates of each program/professional type (e.g. reporting will distinguish between physicians, nurses, dentists, physical therapists, and so on) and by practitioner specialty to the extent possible.
 - These data will be presented in a detailed annual report. Updates will be provided quarterly, as available.

As a part of the Annual reports for Demonstration Years 11 and 12, the state must collect and report data from the Commerce Corporation's existing database on the tracking of the following items for the Wavemaker DSHP project. Per Attachment P, tracking and reporting will include:

- Number of Fellowship awardees and the estimated volume of Medicaid patients served by each awardee each year.
- Number of Fellowship awardees who have fulfilled their annual work commitment by working with a Medicaid provider serving Medicaid members and description of specific health care/medical job (job placement and employer information) in RI for each Fellowship awardee.
- These data will be presented in a detailed annual report. Updates will be provided quarterly, as available.

In addition, as part of the Annual reports for Demonstration Years 11 and 12, the State must analyze whether support for DSHP programs resulted in a net increase in state spending (adjusted for inflation) in federally matched state expenditures.

XXIII. GENERAL FINANCIAL REQUIREMENTS UNDER TITLE XIX

139. **Reporting Expenditures under the Demonstration.** The following describes the reporting of expenditures subject to the Budget Neutrality agreement:
- a. Tracking Expenditures. In order to track expenditures under this demonstration, the state must report demonstration expenditures through the Medicaid and Children's Health Insurance Program Budget and Expenditure System (MBES/CBES), following routine CMS-64 reporting instructions outlined in section 2500 of the State Medicaid Manual. All demonstration expenditures claimed under the authority of title XIX of the Act and subject to the BN expenditure limit must be reported each quarter on separate Forms CMS-64.9 Waiver and/or 64.9P Waiver, identified by the demonstration project number (11-W-00304/0) assigned by CMS, including the project number extension which indicates the Demonstration Year (DY) in which

services were rendered.

- b. Cost Settlements. For monitoring purposes, cost settlements attributable to the demonstration must be recorded on the appropriate prior period adjustment schedules (Form CMS-64.9P Waiver) for the Summary Sheet Line 10B, in lieu of Lines 9 or 10C. For any cost settlement not attributable to this demonstration, the adjustments should be reported as otherwise instructed in the State Medicaid Manual.
- c. Pharmacy Rebates. The state may propose a methodology for assigning a portion of pharmacy rebates to the demonstration in a way that reasonably reflects the actual rebate-eligible pharmacy utilization of the demonstration population, and which reasonably identifies pharmacy rebate amounts with DYs. Use of the methodology is subject to the approval in advance by the CMS Regional Office, and changes to the methodology must also be approved in advance by the Regional Office. The portion of pharmacy rebates assigned to the demonstration using the approved methodology will be reported on the appropriate Forms CMS-64.9 Waiver for the demonstration and not on any other CMS-64.9 form (to avoid double counting). Each rebate amount must be distributed as state and Federal revenue consistent with the federal matching rates under which the claim was paid.
- d. Use of Waiver Forms. For each demonstration year, separate Forms CMS-64.9 Waiver and/or 64.9P Waiver must be completed, using the waiver names listed below. Expenditures should be allocated to these forms based on the guidance which follows.
 - i. **SUD IMD:** All expenditures for costs of medical assistance that could be covered, were it not for the IMD prohibition under the state plan, provided to otherwise eligible individuals during a month in an IMD.
 - 1) SUD IMD Expenditures
 - 2) Other Waiver Forms are defined in the charts below.

Demonstration population number	CMS-64 Eligibility Group Reporting	PMPM Grouping for Without Waiver Budget Neutrality Worksheets
Budget Population 1	ABD no TPL	ABD no TPL
Budget Population 2 (State plan)	ABD TPL	ABD TPL
Budget Population 3	RItCare	RItCare
Budget Population 4	CSHCN	CSHCN
Budget Population 5	EFP	Family Planning Group

Budget Population 6	Pregnant Expansion	Rlte Care
Budget Population 8	Substitute care	CSHCN
Budget Population 9	CSHCN Alt	CNOM
Budget Population 10	Elders 65 and over	CNOM
Budget Population 11	217-like group Category Needy-Highest	217-like Group
Budget Population 12	217-like group Category Needy-High	217-like Group
Budget Population 13	217-like group Medically Needy	217-like Group
Budget Population 14	SED/IDD Children	CNOM
Budget Population 15	AD Risk for LTC	CNOM
Budget Population 16	Adult Mental Unins	CNOM

Demonstration population number	CMS-64 Eligibility Group Reporting	PMPM Grouping for Without Waiver Budget Neutrality Worksheets
Budget Population 17	Youth Risk Medic	CNOM
Budget Population 18	HIV	CNOM
Budget Population 19	AD Non-working	CNOM
Budget Population 20	Alzheimer adults	CNOM
Budget Population 21	Beckett aged out	CNOM
Budget Population 22	New Adult Group	Low-Income Group
Budget Population 23	WM-DSHP TC- DSHP RICAC-DSHP CFAIDE-DSHP CAP-DSHP HWD-DSHP ET-DSHP	n/a

Demonstration services number	CMS-64 Eligibility Group Reporting	PMPM Grouping for Without Waiver Budget Neutrality Worksheets
Budget Services 1	Windows	CNOM
Budget Services 2	RIteShare & Colltns	RIte Share
Budget Services 3	Other Payments	RIte Care
Budget Services 4	Core Preventive and Therapeutic Services	CNOM
Budget Services 5	Recovery Navigation	CNOM
Budget Services 6	Peer Recovery and FYSP	CNOM

Demonstration population number	CMS-64 Eligibility Group Reporting	PMPM Grouping for Without Waiver Budget Neutrality Worksheets
Budget Services 7	Family Home Visitation	CNOM
Budget Services 8	Home-Based Primary Care	CNOM
Budget Services 9	Behavioral LINK	CNOM
Budget Services 10	DCM	CNOM
Budget Services 12	Home Stabilization	CNOM
Budget Services 13	Telephonic Psychiatric Consultation	CNOM

Description of Budget Services.

- i. Budget Services 1 [Windows]. Cost of replacement windows in residences of lead poisoned eligibles.
 - ii. Budget Services 2 [RIteShare & Colltns]. Premiums paid by state for ESI coverage and premiums paid by RIte Care enrollees.
 - iii. Budget Services 3 [Other Payments]. Payments to health plans for performance incentives; risk sharing; and stop loss, as well as FQHC supplemental payments.
 - iv. Budget Services 4 [Core Preventive Services]. Core and preventive and home and community-based therapeutic services for Medicaid-eligible youth and adults.
- e. **Demonstration Years.** The demonstration years are as follows:

<i>Demonstration Year 11</i>	<i>January 1, 2019, - December 31, 2019</i>	<i>12 Months</i>
<i>Demonstration Year 12</i>	<i>January 1, 2020, - December 31, 2020</i>	<i>12 Months</i>
<i>Demonstration Year 13</i>	<i>January 1, 2021, - December 31, 2021</i>	<i>12 Months</i>

<i>Demonstration Year 14</i>	<i>January 1, 2022, - December 31, 2022</i>	<i>12 Months</i>
<i>Demonstration Year 15</i>	<i>January 1, 2023, - December 31, 2023</i>	<i>12 Months</i>

- 140. Budget Neutrality Monitoring Tool.** The state and CMS will jointly develop a BN monitoring tool (using a mutually agreeable spreadsheet program) for the state to use for quarterly BN status updates including established baseline and member months’ data and other in situations when an analysis of BN is required. The tool will incorporate the “C Report” for monitoring actual expenditures subject to BN. A working version of the monitoring tool will be available for the state’s first Annual Report.
- 141. Quarterly Expenditure Reports:** The state must provide quarterly expenditure reports using the Form CMS-64 to report total expenditures for services provided through this under the Medicaid program, including those provided through the demonstration under section 1115 authority that are subject to budget neutrality. This project is approved for expenditures applicable to services rendered during the demonstration period. CMS will provide FFP for allowable demonstration expenditures only so long as they do not exceed the pre-defined limits as specified in these STCs. FFP will be provided for expenditures net of collections in the form of pharmacy rebates, cost sharing, or third party liability.
- 142. Expenditures Subject to the Budget Neutrality Agreement.** For the purpose of this section, the term “expenditures subject to the budget neutrality agreement” means expenditures for the EGs outlined in Section XII, Monitoring Budget Neutrality for the Demonstration, except where specifically exempted. All expenditures that are subject to the budget neutrality agreement are considered demonstration expenditures and must be reported on Forms CMS-64.9 Waiver and/or 64.9P Waiver. purpose of this section, the term “expenditures subject to the budget neutrality limit” will include the following:
- a. All medical assistance expenditures (including those authorized in the Medicaid State plan, through section 1915(c) waivers, and through section 1115 waivers and expenditure authorities, but excluding the increased expenditures resulting from the mandated increase in payments to physicians) made on behalf of all demonstration participants listed in the table in STC 137, with dates of service within the demonstration’s approval period;
 - b. SUD IMD services.
- 143. Administrative Costs.** Administrative costs will not be included in the budget neutrality limit, but the state must separately track and report additional administrative costs that are directly attributable to the demonstration, using separate CMS-64.10 waiver and 64.10 waiver forms, with waiver name “ADM.”

144. Claiming Period. All claims for expenditures subject to the budget neutrality limit (including any cost settlements) must be made within two (2) years after the calendar quarter in which the state made the expenditures. Furthermore, all claims for services during the demonstration period (including any cost settlements) must be made within two (2) years after the conclusion or termination of the demonstration. During the latter 2-year period, the state must continue to identify separately net expenditures related to dates of service during the operation of the section 1115 demonstration on the Form CMS-64 in order to properly account for these expenditures in determining budget neutrality.

145. Reporting Member Months. The following describes the reporting of member months for demonstration populations.

- a. For the purpose of calculating the BN expenditure limit and for other purposes, the state must provide to CMS, as part of the BN Monitoring Tool required under STC 138, the actual number of eligible member months for each MEG described in subparagraph D below. The state must submit a statement accompanying the BN Monitoring Tool, which certifies the accuracy of this information. To permit full recognition of “in-process” eligibility, reported counts of member months may be subject to revision.
- b. The term "eligible member/months" refers to the number of months in which persons are eligible to receive services. For example, a person who is eligible for 3 months contributes 3 eligible member months to the total. Two individuals who are eligible for 2 months each contribute 2 eligible member months to the total, for a total of 4 eligible member/months.
- c. The state must report separate member month totals for individuals enrolled in the Rhode Island Comprehensive demonstrations and the member months must be subtotaled according to the MEGs defined in STC 151) below.
- d. The state must report member months according to the MEGs defined below.
 - i. **SUD IMD:** SUD IMD Member Months are months of Medicaid eligibility during which the individual is an inpatient in an IMD under terms of the demonstration for any day during the month and must be reported for the SUD IMD MEG, as applicable.

146. Standard Medicaid Funding Process. The standard Medicaid funding process must be used during the demonstration. The state must estimate matchable Medicaid expenditures (total computable and federal share) subject to the budget neutrality expenditure limit and separately report those expenditures by quarter for each FFY on the Form CMS-37 (narrative section) for both Medical Assistance Payments (MAP) and state and Local Administrative Costs (ADM). As a supplement to the Form CMS-37, the state will provide updated estimates of expenditures subject to the budget neutrality limit. CMS will make federal funds available based upon the state's estimate, as approved by CMS. Within 30 calendar days after the end of each quarter, the state must submit the Form CMS-64 quarterly Medicaid expenditure report, showing Medicaid

expenditures made in the quarter just ended. CMS will reconcile expenditures reported on the Form CMS-64 quarterly with federal funding previously made available to the state, and include the reconciling adjustment in the finalization of the grant award to the state.

- 147. Extent of Federal Financial Participation for the Demonstration.** Subject to CMS approval of the source(s) of the non-federal share of funding. CMS will provide FFP at the applicable federal matching rate for the demonstration as a whole for the following, subject to the limits described in Section XXIII:
- a. Administrative costs, including those associated with the administration of the demonstration;
 - b. Net expenditures and prior period adjustments of the Medicaid program that are paid in accordance with the approved Medicaid state plan; and
 - c. Medical assistance expenditures and prior period adjustments made under section 1115 demonstration authority with dates of service during the demonstration extension period; including those made in conjunction with the demonstration, net of enrollment fees, cost sharing, pharmacy rebates, and all other types of third party liability.
- 148. Sources of Non-Federal Share.** The state certifies that the matching non-federal share of funds for the demonstration is state/local monies. The state further certifies that such funds must not be used as the match for any other federal grant or contract, except as permitted by law. All sources of non-federal funding must be compliant with section 1903(w) of the Act and applicable regulations. In addition, all sources of the non-federal share of funding are subject to CMS approval.
- a. CMS may review at any time the sources of the non-federal share of funding for the demonstration. The state agrees that all funding sources deemed unacceptable by CMS must be addressed within the time frames set by CMS.
 - b. Any amendments that impact the financial status of the program must require the state to provide information to CMS regarding all sources of the non-federal share of funding.
 - c. The state assures that all health care-related taxes comport with section 1903(w) of the Act and all other applicable federal statutory and regulatory provision, as well as the approved Medicaid state plan.
- 149. State Certification of Funding Conditions.** Under all circumstances, health care providers must retain 100 percent of the reimbursement amounts claimed by the state as demonstration expenditures. Moreover, no pre-arranged agreements (contractual or otherwise) may exist between the health care providers and the state government to return and/or redirect any portion of the Medicaid payments. This confirmation of Medicaid payment retention is made with the understanding that payments that are the normal operating expenses of conducting business (such as payments related to taxes—including health care provider-related taxes—fees, and business relationships with governments that are unrelated to Medicaid and in

which there is no connection to Medicaid payments) are not considered returning and/or redirecting a Medicaid payment.

150. Program Integrity. The state must have a process in place to ensure that there is no duplication of federal funding for any aspect of the demonstration.

151. Budget Neutrality Mid-Course Correction Adjustment Request. No more than once per demonstration year, the state may request that CMS make an adjustment to its budget neutrality agreement based on changes to the state's Medicaid expenditures that are unrelated to the demonstration and/or outside the state's control, and/or that result from a new expenditure that is not a new demonstration-covered service or population and that is likely to further strengthen access to care.

a. Contents of Request and Process. In its request, the state must provide a description of the expenditure changes that led to the request, together with applicable expenditure data demonstrating that due to these expenditures, the state's actual costs have exceeded the budget neutrality cost limits established at demonstration approval. The state must also submit the budget neutrality update described in STC 149(c). If approved, an adjustment could be applied retrospectively to when the state began incurring the relevant expenditures, if appropriate. Within 120 days of acknowledging receipt of the request, CMS will determine whether the state needs to submit an amendment pursuant to STC 7. CMS will evaluate each request based on its merit and will approve requests when the state establishes that an adjustment to its budget neutrality agreement is necessary due to changes to the state's Medicaid expenditures that are unrelated to the demonstration and/or outside of the state's control, and/or that result from a new expenditure that is not a new demonstration-covered service or population and that is likely to further strengthen access to care.

b. Types of Allowable Changes. Adjustments will be made only for actual costs as reported in expenditure data. CMS will not approve mid-demonstration adjustments for anticipated factors not yet reflected in such expenditure data. Examples of the types of mid-course adjustments that CMS might approve include the following:

- i. Provider rate increases that are anticipated to further strengthen access to care;
- ii. CMS or state technical errors in the original budget neutrality formulation applied retrospectively, including, but not limited to the following: mathematical errors, such as not aging data correctly; or unintended omission of certain applicable costs of services for individual MEGs;
- iii. Changes in federal statute or regulations, not directly associated with Medicaid, which impact expenditures;

- iv. State legislated or regulatory change to Medicaid that significantly affects the costs of medical assistance;
- v. When not already accounted for under Emergency Medicaid 1115 demonstrations, cost impacts from public health emergencies;
- vi. High cost innovative medical treatments that states are required to cover; or,
- vii. Corrections to coverage/service estimates where there is no prior state experience (e.g., SUD) or small populations where expenditures may vary widely.

c. Budget Neutrality Update. The state must submit an updated budget neutrality analysis with its adjustment request, which includes the following elements:

- i. Projected without waiver and with waiver expenditures, estimated member months, and annual limits for each DY through the end of the approval period; and,
- ii. Description of the rationale for the mid-course correction, including an explanation of why the request is based on changes to the state’s Medicaid expenditures that are unrelated to the demonstration and/or outside the state’s control, and/or is due to a new expenditure that is not a new demonstration-covered service or population and that is likely to further strengthen access to care.

XXIV. MONITORING BUDGET NEUTRALITY FOR THE DEMONSTRATION

- 152. Limit on Title XIX Funding.** The state will be subject to a limit on the amount of federal title XIX funding that the state may receive on selected Medicaid expenditures during the period of approval of the demonstration. The limit is determined by using the per capita cost method described in STCs 151 and 153, and budget neutrality expenditure limits are set on a yearly basis with a cumulative budget neutrality expenditure limit for the length of the entire demonstration. Actual expenditures subject to the budget neutrality expenditure limit must be reported by the state using the procedures described in section XXIV. The data supplied by the state to CMS to set the annual caps is subject to review and audit, and if found to be inaccurate, will result in a modified budget neutrality expenditure limit. CMS’ assessment of the state’s compliance with these annual limits will be done using the Schedule C report from the CMS-64.
- 153. Risk.** The state will be at risk for the per capita cost (as determined by the method described below) for state plan and hypothetical populations, but not at risk for the number of participants in the demonstration population. By providing FFP without regard to enrollment in the for all demonstration populations, CMS will not place the state at risk for changing economic conditions. However, by placing the state at

risk for the per capita costs of the demonstration populations, CMS assures that the demonstration expenditures do not exceed the levels that would have been realized had there been no demonstration.

- 154. Calculation of the Budget Neutrality Limit and How It Is Applied.** For the purpose of calculating the overall budget neutrality limit for the demonstration, separate annual budget limits will be calculated for each DY on a total computable basis, by multiplying the predetermined PMPM cost for each EG (shown on the table in STC 155) by the corresponding actual member months total, and summing the results of those calculations. The annual limits will then be added together to obtain a budget neutrality limit for the entire demonstration period. The federal share of this limit will represent the maximum amount of FFP that the state may receive during the demonstration period for the types of demonstration expenditures described below. The federal share will be calculated by multiplying the total computable budget neutrality limit by Composite Federal Share, which is defined in STC 154 below. The demonstration expenditures subject to the budget neutrality limit are those reported under the following waiver names described in STC 137(d).

Impermissible DSH, Taxes, or Donations. CMS reserves the right to adjust the budget neutrality ceiling to be consistent with enforcement of laws and policy statements, including regulations and letters regarding impermissible provider payments, health care related taxes, or other payments (if necessary adjustments must be made). CMS reserves the right to make adjustments to the budget neutrality limit if any health care related tax that was in effect during the base year, or provider- related donation that occurred during the base year, is determined by CMS to be in violation of the provider donation and health care related tax provisions of section 1903(w) of the Social Security Act. Adjustments to annual budget targets will reflect the phase out of impermissible provider payments by law or regulation, where applicable

Main Budget Neutrality Test.

The trend rates and per capita cost estimates for each EG for each year of the demonstration are listed in the table below. The PMPM cost estimates are based on actual Medicaid PMPM costs from SFY 2012-2017, trended forward using trends based on the lower of state historical trends from SFY 2012 to 2017 and the FFY 2018 President's Budget trends.

MEG	Trend Rate	DY 11 (CY 2019)	DY 12 (CY 2020)	DY 13 (CY 2021)	DY 14 (CY 2022)	DY 15 (CY 2023)
		PMPM	PMPM	PMPM	PMPM	PMPM
ABD Adults No TPL	4.3%	\$3,288	\$3,429	\$3,576	\$3,730	\$3,891
ABD Adults TPL	4.3%	\$3,716	\$3,876	\$4,043	\$4,217	\$4,398
Rite Care	4.6%	\$584	\$611	\$639	\$668	\$699
CSHCN	5.0%	\$3,437	\$3,608	\$3,789	\$3,978	\$4,177

155. **Supplemental Tests.** The budget neutrality test for this demonstration includes an allowance for hypothetical populations, which are optional populations that could have been added to the Medicaid program through the state plan, but instead will be covered in the demonstration only. The expected costs of hypothetical populations are reflected in the “without-waiver” budget neutrality expenditure limit. The state must not accrue budget neutrality “savings” from hypothetical populations. To accomplish these goals, a separate expenditure cap is established for the hypothetical groups, to be known as Supplemental Budget Neutrality Test 1.

- a. The MEGs listed in the table below are for the Supplemental Budget Neutrality Test 1.

MEG	Trend Rate	DY 11 (CY 2019)	DY 12 (CY 2020)	DY 13 (CY 2021)	DY 14 (CY 2022)	DY 15 (CY 2023)
217-like Group	3.1%	\$4,222	\$4,353	\$4,488	\$4,627	\$4,770
Family Planning Group	4.8%	\$24	\$25	\$26	\$28	\$29
SUD IMD	4.8%	\$3,948	\$4,138	\$4,336	\$4,544	\$4,762

- b. The Supplemental Cap 1 is calculated by taking the PMPM cost projection for each group in the above table in each DY, times the number of eligible member months for that group and DY, and adding the products together across groups and DYs. The Federal share of Supplemental Cap 1 is obtained by multiplying the total computable Supplemental Cap 1 by Composite Federal Share 2.
- c. Supplemental Budget Neutrality Test 1 is a comparison between the Federal share of Supplemental Cap 1 and total FFP reported by the state

for hypothetical groups under the MEG “217-like group” described in STC 152. If total FFP for hypothetical groups should exceed the Federal share of Supplemental Cap 1, the difference must be reported as a cost against the budget neutrality limit described in paragraph 151.

- 156. Monitoring of New Adult Group Spending and Opportunity to Adjust Projections.** For each DY, a separate annual budget limit for the new adult group will be calculated as the product of the trended monthly per person cost times the actual number of eligible/member months as reported to CMS by the state under the guidelines set forth in STC 151. The trend rates and per capita cost estimates for the New Adult Group are listed in the table below.

MEG	Trend Rate	DY 11 (CY 2019)	DY 12 (CY 2020)	DY 13 (CY 2021)	DY 14 (CY 2022)	DY 15 (CY 2023)
New Adult Group	4.8%	\$990	\$1,038	\$1,088	\$1,140	\$1,195

- a. If the state’s experience of the take up rate for the new adult group and other factors that affect the costs of this population indicates that the new adult group PMPM limit described above may underestimate the actual costs of medical assistance for the new adult group, the state has the opportunity to submit an adjustment the PMPM limit, along with detailed expenditure data to justify this, for CMS review without submitting an amendment pursuant to STC. In order to ensure timely adjustments to the PMPM limit for a demonstration year, the revised projection must be submitted to CMS by no later than the end of the third quarter of the demonstration year for which the adjustment would take effect.
- b. The budget limit for the new adult group is calculated by taking the PMPM cost projection for the above group in each DY, times the number of eligible member months for that group and DY, and adding the products together across DYs. The federal share of the budget neutrality cap is obtained by multiplying total computable budget neutrality cap by the federal share.
- c. The state will not be allowed to obtain budget neutrality “savings” from this population.
- d. If total FFP reported by the state for the new adult group should exceed the federal share of FFP for the budget limit for the new adult group by more than 3 percent following each demonstration year, the state must submit a corrective action plan to CMS for approval.

Supplemental Budget Neutrality Test 3: Substance Use Disorder Expenditures.

As part of the SUD initiative, the state may receive FFP for the continuum of services to treat OUD and other SUDs, provided to Medicaid enrollees in an IMD with a

primary diagnosis of SUD. These “SUD Services” are, or could be state plan services that would be eligible for reimbursement if not for the IMD exclusion; therefore, they are being treated as hypothetical for the purposes of budget neutrality. Hypothetical services can be treated in budget neutrality in a way that is similar to how Medicaid state plan services are treated, by including them as a “pass through” in both the without-waiver and with-waiver calculations. The state may only claim FFP via demonstration authority for the SUD Services listed in Table 7 that will be provided in an IMD for Medicaid beneficiaries with a primary diagnosis of SUD. However, the state will not be allowed to obtain budget neutrality “savings” from these services. Therefore, a separate expenditure cap is established for SUD IMD services, to be known as Supplemental Budget Neutrality Test 3.

- a. The MEG(s) listed in the table below is/are included in SUD IMD Supplemental BN Test(s).

<i>SUD MEG(s)</i>	<i>Trend Rate</i>	<i>DY 15 PMPM</i>	<i>DY 16 PMPM</i>	<i>DY 17 PMPM</i>	<i>DY 18 PMPM</i>	<i>DY 19 PMPM</i>
<i>SUD IMD</i>	4.8%	\$3,948	\$4,138	\$4,336	\$4,544	\$4,762

- b. SUD IMD expenditures cap(s) is/are calculated by multiplying the projected PMPM for each SUD IMD MEG, each DY, by the number of actual eligible SUD IMD member months for the same MEG/DY—and summing the products together across all DYs. The federal share of the SUD IMD expenditure cap(s) is/are obtained by multiplying those caps by the Composite Federal Share (see STC 154).
- c. SUD IMD Supplemental BN Test(s) is/are a comparison between the federal share of SUD IMD expenditure cap(s) and total FFP reported by the state for the SUD IMD MEG(s).

157. Composite Federal Share Ratios. The Composite Federal Share is the ratio that will be used to convert the total computable budget neutrality limit to federal share. The Composite Federal Share is the ratio calculated by dividing the sum total of FFP received by Rhode Island on actual demonstration expenditures during the approval period by total computable demonstration expenditures for the same period, as reported through MBES/CBES and summarized on Schedule C. Since the actual final Composite Federal Share will not be known until the end of the demonstration’s approval period, for the purpose of interim monitoring of budget neutrality, a reasonable estimate of Composite Federal Share may be developed and used through the same process or through an alternative mutually agreed to method.

158. Recognizing Budget Neutrality Savings. Beginning January 1, 2019, the net variance between the without-waiver cost and actual with-waiver cost will be reduced for selected Medical population based EGs. The reduced variance, to be calculated as a percentage of the total variance, will be used in place of the total variance to determine overall budget neutrality for the demonstration.

(Equivalently, the difference between the total variance and reduced variance could be subtracted from the without-waiver cost estimate.) For the first five years that an eligibility group is enrolled in managed care, savings are carried forward in full. For the first five years that a set of services is subject to managed care, savings are also carried forward in full. The formula for calculating the reduced variance is: reduced variance equals total variance times applicable percentage. The applicable percentages for each EG and DY are determined based on how long the associated population has been enrolled in managed care subject to this demonstration; lower percentages are for longer established managed care populations. The EGs affected by this provision and the applicable percentages are shown in the table below, except that if the total variance for an EG in a DY is negative, the applicable percentage is 100 percent.

<i>EG</i>	<i>DY 15 (CY 2019)</i>	<i>DY 16 (CY 2020)</i>	<i>DY 17 (CY 2021)</i>	<i>DY 18 (CY 2022)</i>	<i>DY 19 (CY 2023)</i>
<i>ABD Adults TPL</i>	100%	100%	90%	80%	70%
<i>ABD Adults no TPL</i>	100%	100%	90%	80%	70%
<i>Rite Care</i>	25%	25%	25%	25%	25%
<i>CSHCN</i>	25%	25%	25%	25%	25%

159. Exceeding Budget Neutrality. The budget neutrality limits calculated in STC 151 will apply to actual expenditures for demonstration services as reported by the state under section XXIV of these STCs. If at the end of the demonstration period the budget neutrality limit has been exceeded, the excess federal funds will be returned to CMS. If the demonstration is terminated prior to the end of the demonstration period, the budget neutrality test will be based on the time period through the termination date.

160. Enforcement of Budget Neutrality. CMS will enforce the budget neutrality agreement over the life of the demonstration, rather than on an annual basis. However, if the state exceeds the calculated cumulative target limit by the percentage identified below for any of the DYs, the state must submit a corrective action plan to CMS for approval.

Demonstration Year	Cumulative Target Definition	Percentage
DY 11	Cumulative budget neutrality limit plus:	2.0 percent
DY 12	Cumulative budget neutrality limit plus:	1.5 percent
DY 13	Cumulative budget neutrality limit plus:	1.0 percent

DY 14	Cumulative budget neutrality limit plus:	0.5 percent
DY 15	Cumulative budget neutrality limit plus:	0 percent

- 161. Accountable Entity Roadmap.** The Accountable Entity Roadmap will be a conceptualized living document that will be updated annually to ensure that best practices and lessons are learned throughout implementation that can be leveraged and incorporated into the State’s overall vision of delivery system reform. The state must submit annually the Accountable Entity Roadmap outlined in STC #44. The document must contain elements of STC #44 a-o.
- 162. Evaluation of the Marketplace Subsidy Program.** The state must submit an interim evaluation of the Marketplace subsidy program to CMS by May 1, 2020, that meets the requirements of the CMS-approved evaluation design. The state must evaluate the number of individuals who participate in the program compared against the number of individuals who were enrolled in RItE Care and RItE Share in December 31, 2013. The state must evaluate whether and how the change in the premium subsidy affected enrollment.
- 163. Interim Evaluation of the Accountable Entities Program.** The state submitted an interim evaluation of the Accountable Entities program to CMS on December 1, 2018. The state must evaluate the number of Certified Accountable Entities that participate in the program and the benchmarks used for the final evaluation of the effectiveness of the AEs.

XXV. SCHEDULE OF DELIVERABLES FOR THE DEMONSTRATION PERIOD

Date	Deliverable	STC
30 days after approval date	State acceptance of demonstration Waivers, STCs, and Expenditure Authorities	Approval letter
90 days after SUD program approval date	SUD Implementation Protocol	STC 89(a)
150 days after SUD program approval date	SUD Monitoring Protocol	STC 89(b)
180 days after approval date	Draft Evaluation Design	129

60 days after receipt of CMS comments	Revised Draft Evaluation Design	130
30 days after CMS Approval	Approved Evaluation Design published to state's website	STC 130
June 30, 2020	Mid-Point Assessment	STC 89(c)
One year prior to the end of the demonstration, or with renewal application	Draft Interim Evaluation Report	STC 132
60 days after receipt of CMS comments	Final Interim Evaluation Report	STC 132
18 months of the end of the demonstration	Draft Summative Evaluation Report	STC 133
60 calendar days after receipt of CMS comments	Final Summative Evaluation Report	STC 133(a)
90 days after middle of DY4 (September 30, 2020)	Submit Draft SUD Mid-point Assessment	STC 89(c)
60 calendar days after receipt of CMS comments	Submit Final SUD Mid-point assessment	STC 89(c)

30 calendar days of CMS approval	Approved Final Summative Evaluation Report published to state's website	STC 133(b)
Monthly Deliverables	Monitoring Calls	STC 125
Quarterly Deliverables Due 60 days after end of each quarter, except 4 th quarter	Quarterly Monitoring Reports	STC 122
	Quarterly Expenditure Reports	STC 141
Annual Deliverables - Due 90 days after end of each 4 th quarter	Annual Reports	STC 122

Within 120 calendar days prior to the expiration of the demonstration	Draft Close-out Operational Report	STC 124
30 calendar days after receipt of CMS comments	Final Close-out Operational Report	STC 124(d)

**ATTACHMENT A – Managed Care and Fee For Service Demonstration Only
Benefits**

These benefits are not provided under the Rhode Island Medicaid State Plan, but only under the demonstration, including risk based managed care and PCCM programs.

Nutrition services
Individual/group education, parenting and childbirth education classes
Tobacco cessation services for non-pregnant beneficiaries
Window replacement for lead-poisoned children
Complementary alternative medicine services to a subset of enrollees with chronic pain diagnoses

ATTACHMENT B - Core, Preventive, and Therapeutic Home and Community-based Service Definitions

The services under this demonstration are limited to additional services not otherwise covered under the state plan, including EPSDT, but consistent with demonstration objectives of avoiding institutionalization.

CORE SERVICES - Core services are only eligible to members that have a **High or Highest level of care.**

Senior Companion/Adult Companion Services

Non-medical care, supervision, and socialization provided to a functionally impaired adult. Companions may assist or supervise the beneficiary with such tasks as meal preparation, laundry, and shopping. The provision of companion services does not entail hands-on nursing care. Providers may also perform light housekeeping tasks that are incidental to the care and supervision of the beneficiary. This service is provided in accordance with a therapeutic goal in the service plan of care.

Assisted Living Services

Personal care and supportive services (homemaker, chore, attendant services, companion services, meal preparation) that are furnished to HCBS beneficiaries who reside in a setting that meets the HCBS setting requirements and includes 24-hour on-site response capability to meet scheduled or unpredictable resident needs and to provide supervision, safety and security. Services also include social and recreational programming, and medication assistance (to the extent permitted under State law). Services that are provided by third parties must be coordinated with the assisted living provider. Nursing and skilled therapy services are incidental rather than integral to the provision of assisted living services. Payment is not to be made for 24-hour skilled care. Services furnished are required to meet a beneficiary's LTSS needs in a manner that promotes self-reliance, dignity and independence. Services may be provided in settings licensed by the state at various levels that reflect their capacity to provide different kinds of Medicaid services, depending on a beneficiary's level of care needs based on their licensure authority and capacity to provide specific packages of services to Medicaid beneficiaries with varying levels of acuity needs.

Personalized care is furnished to an individual who resides in his/her own living units (which may include dually occupied units when both occupants consent to the arrangement), which may or may not include kitchenette and/or living rooms, and which contain bedrooms and toilet facilities. The consumer has a right to privacy. Living units may be locked at the discretion of the consumer, except when a physician or mental health professional has certified in writing that the consumer is sufficiently cognitively impaired as to be a danger to self or others if given the opportunity to lock the door. (This requirement does not apply where it conflicts with

fire code.) Each living unit is separate and distinct from each other unit. The facility must have a central dining room, living room, or parlor, and common activity center(s) (which may also serve as living room or dining room). The consumer retains the right to assume risk, tempered only by the individual's ability to assume responsibility for that risk. Care must be furnished in a way that fosters the independence of each individual to facilitate continued community tenure. Routines of care provision and service delivery must be consumer-driven to the maximum extent possible, and must treat each person with dignity and respect. Costs of room and board are excluded from payments for assisted living services.

Assistive Technology

Assistive technology means an item, piece of equipment, service animal or product system, whether acquired commercially, modified, or customized, that is used to increase, maintain, or improve functional capabilities of beneficiaries, optimize their health and promote independence and self-care. Assistive technology service means a service that directly assists a beneficiary in the selection, acquisition, or use of an assistive technology device. The services under the demonstration are limited to additional services not otherwise covered under the state plan, including EPSDT, but consistent with waiver objectives of avoiding institutionalization. Assistive technology includes:

- The evaluation of the assistive technology needs of a beneficiary, including a functional evaluation of the impact of the assistive technology and appropriate services to the beneficiary in the customary environment of the beneficiary;
- Services consisting of purchasing, leasing, or otherwise providing for the acquisition of assistive technology devices for beneficiaries;
- Services consisting of selecting, designing, fitting, customizing, adapting, applying, maintaining, repairing, or replacing assistive technology devices;
- Coordination and use of necessary therapies, interventions, or services with assistive technology devices, such as therapies, interventions, or services associated with other services in the service plan;
- Training or technical assistance for the beneficiary, or, where appropriate, the family members, guardians, advocates, or authorized representatives of the beneficiary; and
- Training or technical assistance for professionals or other individuals who provide services to, employ, or are otherwise substantially involved in the major life functions of beneficiaries.

Bereavement Counseling

Counseling provided to the beneficiary and/or family members in order to guide and help them cope with the beneficiary's illness and the related stress that accompanies the continuous, daily care required by a terminally ill child. Enabling the beneficiary

and family members to manage this stress improves the likelihood that the individual with a life-threatening condition (certification of terminal illness) will continue to be cared for at home, thereby preventing premature and otherwise unnecessary institutionalization. Bereavement activities and opportunities for dialog offer the family a mechanism for expressing emotion and asking questions about death and grieving in a safe environment, thereby potentially decreasing complications for the family after the child dies. Bereavement counseling is initiated and billed while the child is receiving the HCBS but may continue after the death of the child for a period of up to six months. This service is for people who do not elect hospice.

Career Planning

Career planning is a person-centered, comprehensive employment planning and support service that provides assistance for HCBS program beneficiaries to obtain, maintain or advance in competitive employment or self-employment. It is a focused, time-limited service engaging a beneficiary in identifying a career direction and developing a plan for achieving competitive, integrated employment at or above the state's minimum wage. The outcome of this service is documentation of the beneficiary's stated career objective and a career plan used to guide individual employment support.

Case Management

Services that assist beneficiaries in gaining access to needed HCBS and other state plan services, as well as medical, social, educational, and other services, regardless of the funding source for the services to which access is gained. Case management may be delivered using telehealth or other electronic methods of case management delivery if this meets the individual's needs and preserves the health and welfare of the individual. All individuals, including those who choose to receive case management through an electronic delivery method, will receive an in-person contact *at least* once every six (6) months. If the individual's initial or annual assessment shows they need an in-person contact more than once every 6 months, or if it is the individual's preference to receive in-person contact more frequently, the case manager must provide an in-person contact more frequently than every 6 months. Case managers are responsible for ongoing monitoring of the provision of services included in the individual's plan of care; contact requires a response from the individual in order to be considered monitoring. Case managers initiate and oversee the process of assessment and reassessment of the individual's level of care and review of plans of care on an annual basis and when there are significant changes in client circumstances.

Chore Services

Services needed to maintain the home in a clean, sanitary and safe environment. This service includes heavy household chores such as washing floors, windows and walls, tacking down loose rugs and tiles, moving heavy items of furniture in order to provide safe access and egress. These services are provided only when neither the

beneficiary nor anyone else in the household is capable of performing or financially providing for them, and where no other relative, caregiver, landlord, community/volunteer agency, or third-party payor is capable of or responsible for their provision. In the case of rental property, the responsibility of the landlord, pursuant to the lease agreement, is examined prior to any authorization of service.

Community-Based Supported Living Arrangements (CSLA)

Enhanced and specialized home and community-based services for persons with more intensive LTSS needs provided through Medicaid certified living arrangements – including shared living/adult foster care, and other adult supportive care homes – that are authorized by the state to address high level functional/clinical needs that otherwise would require care in an institutional-setting, such as dementia care, limited skilled nursing care, and health stabilization services. To meet the certification standards to participate in the program set forth in state law, HCBS providers must establish and maintain an acuity-based, tiered service and payment system that ties reimbursements to: beneficiary's clinical/functional level of need; the scope of services and supports provided; and specific quality and outcome measures. Such standards establish the Medicaid state plan and core waiver services that each type of provider must deliver, the range of acuity-based service enhancements that must be made available to beneficiaries with more intensive care needs, and the minimum state licensure and/or certification requirements a provider must meet to participate at each service/payment level. The standards shall also establish any additional requirements, terms, or conditions that a provider must meet to ensure beneficiaries have access to high quality, cost-effective care. The total number of individuals receiving the CSLA in a private home of a principal care provider cannot exceed two (2).

Community Transition Services

Community Transition Services are non-recurring set-up expenses for individuals who are transitioning from an institutional or another provider-operated living arrangement to a living arrangement in a private residence where the person is directly responsible for his or her own living expenses. Allowable expenses are those necessary to enable an individual to establish a basic household that do not constitute room and board and may include:

- One-time security deposits that are required to obtain a lease on an apartment or home;
- One-time payment for the following services: Essential household furnishings and moving expense required to occupy and use a community domicile, including furniture, window coverings, food preparation items, and bed/bath linens;
- One-time payment for Set-up fees or deposits for utility or service access, including telephone, electricity, heating and water;
- One-time payment for services necessary for the individual's health and safety

- such as pest eradication and one-time cleaning prior to occupancy;
- One-time payment for Moving expenses;
- Necessary home accessibility adaptations;

Activities to assess need, arrange for and procure needed resources.

- Assistance with obtaining needed items for housing applications (e.g., assistance with obtaining and paying for a birth certificate or a state identification card, transportation to the local Social Security office);

Community Transition Services are furnished only to the extent that they are reasonable and necessary as determined through the service plan development process, clearly identified in the service plan, and the person is unable to meet such expense or when the services cannot be obtained from other sources.

Consultative Clinical and Therapeutic Services

Clinical and therapeutic services that assist unpaid caregivers in carrying out individual treatment/support plans, and that are not covered by the Medicaid State Plan, and are necessary to improve the individual's independence and inclusion in their community. Clinical and therapeutic services are provided by professionals including nursing, psychology, nutrition, counseling and behavior management. The service may include assessment, the development of a home treatment/ support plan, training and technical assistance to carry out the plan and monitoring of the individual and the provider in the implementation of the plan. This service may be delivered in the individual's home or in the community as described in the service plan.

Day Treatment and Supports

Services that are necessary for the diagnosis or treatment of the individual's mental illness or disability. The purpose of this service is to maintain the individual's condition and functional level and to prevent relapse or hospitalization. These services consist of the following elements:

- Individual and group therapy with physicians or psychologists (or other mental health professionals to the extent authorized under State law);
- Occupational therapy, requiring the skills of a qualified occupational therapist;
- Services of social workers, trained psychiatric nurses, and other staff trained to work with individuals with psychiatric illness;
- Drugs and biologicals furnished for therapeutic purposes, provided that the medication is not otherwise available under the State Plan or as a Medicare benefit to a beneficiary;
- Individual activity therapies that are not primarily recreational or diversionary,
- Family counseling (the primary purpose of which is treatment of the individual's condition);

- Training and education of the individual (to the extent that training and educational activities are closely and clearly related to the individual's care and treatment); and
- Diagnostic services.

Meals provided as part of these services shall not constitute a "full nutritional regimen" (3 meals per day). Settings will comply with the HCBS setting regulation by March 2022.

Homemaker Services

Services that consist of the performance of general household tasks (e.g., meal preparation and routine household care) provided by a qualified homemaker, when the individual regularly responsible for these activities is temporarily absent or unable to manage the home and care for him or herself or others in the home.

Home Delivered Meals

The delivery of hot meals and shelf staples to the beneficiary's residence. Meals are available to an individual who is unable to care for his/her nutritional needs because of a functional dependency/disability and who requires this assistance to live in the community. Meals provided under this service will not constitute a full daily nutritional requirement. Meals must provide a minimum of one-third of the current recommended dietary allowance. Provision of home delivered meals will result in less assistance being authorized for meal preparation for individual participants, if applicable.

Home Stabilization

Home Stabilization services are designed to ensure timely access to appropriate, high quality services for individuals who require support to establish or maintain a home, with the goal of promoting successful community living and reducing unnecessary institutionalization, addressing social determinants of health, and promoting a person-centered, holistic approach to care. EOHHS will use the Home Stabilization Certification Standards to certify providers to deliver either time-limited home tenancy teaching services for individuals who require support in obtaining and maintaining a home (Home Tenancy Services), and/or time-limited, one-time home find services to individuals who require support in finding and transitioning to housing (Home Find Services).

Home Tenancy Services include:

- Early identification and intervention for behaviors that may jeopardize housing, such as late rental payment and other lease violations;
- Education and training on the role, rights, and responsibilities of the landlord and tenant;
- Coaching on developing and maintaining key relationships with landlords/property managers with a goal of fostering successful tenancy;

- Assistance in resolving disputes with landlords/neighbors to reduce the risk of eviction or other adverse action;
- Advocacy and linkage with community resources to prevent eviction when housing is, or may be jeopardized;
- Assistance with the housing recertification process;
- Coordinating with the tenant to review, update, and modify their housing support and crisis plan on a regular basis to reflect current needs and address existing or recurring housing retention barriers; and
- Continued training in being a good tenant and lease compliance, including on-going support with activities related to household management.

Home Find Services include:

- Conducting tenant screening and housing assessments that identify the participants' preferences and barriers related to successful tenancy;
- Developing an individualized housing support plan based on housing assessment; assisting with the housing application and search process;
- Identifying resources to cover moving and start-up expenses and assist in arranging for and supporting the details of the move;
- Ensuring that the living environment is safe and ready to move-in; and
- Developing a housing support crisis plan.

Individual Directed Goods and Services

Individual Directed Goods and Services are services, equipment, or supplies not otherwise provided through this HCBS or through the Medicaid State Plan that address an identified need in the service plan (including improving and maintaining the beneficiary's opportunities for full membership in the community) and that meet the following requirements: the item or service would decrease the need for other Medicaid services; AND/OR promote inclusion in the community; AND/OR increase the beneficiary's safety in the home environment; AND the beneficiary does not have the funds to purchase the item or service or the item or service is not available through another source. Individual directed goods and services are purchased from the beneficiary-directed budget through the Self-Directed option. Experimental or prohibited treatments are excluded. Individual directed goods and services must be documented in the service plan.

Integrated Supported Employment

Integrated employment supports are services and training activities provided in regular business and industry settings for persons with disabilities. The outcome of this service is sustained, paid employment and work experience leading to further career development and individual integrated community-based employment for which an individual is compensated at or above the minimum wage, but not less than the customary wage and level of benefits paid by the employer for the same or similar

work performed by individuals without disabilities. Supports may include any combination of the following services: vocational/job-related discovery or assessment, person-centered employment planning, job placement, job development, negotiation with prospective employers, job analysis, training and systematic instruction, job coaching, benefits management, transportation and career advancement services. Other workplace support services may include services not specifically related to job skill training that enable the HCBS beneficiary to be successful in integrating into the job setting. Supported employment must be provided in a manner that promotes integration into the workplace and interaction between beneficiaries and people without disabilities in those workplaces.

Medication Management/administration

Pharmacologic management including review of medication use, both current and historical, if indicated; evaluation of symptoms being treated, side effects and effectiveness of current medication(s), adjustment of medications if indicated, and prescription, provided by a medical professional practicing within the scope of his or her licensure.

Non-Medical Transportation

Assurance of transportation is provided to enable HCBS beneficiaries to gain access to HCBS and other community services, activities and resources, as specified by the service plan when the beneficiary has no other means of transportation. Under 42 CFR §431.53 and 42 CFR §440.170(a) the assurance of transportation to and from medical services provided under the State Plan will also be provided. Whenever possible, family, neighbors, friends, or community agencies which can provide this service without charge are utilized.

Peer Supports

Peer Supports are provided by Peer Support Specialists that bring to the beneficiary a unique vantage point and the skills of lived experiences in either managing a health condition or disability, or in serving as the primary caregiver for a family member with a health condition or disability. This service is intended to provide individuals with a support system to develop and learn healthy living skills, to encourage personal responsibility and self-determination, to link individuals with the tools and education needed to promote their health and wellness (as well as the health and wellness of those that they are caring for, if applicable), and to teach the skills that are necessary to engage and communicate with providers and systems of care. Peer Support Specialists will work under the direction of a licensed healthcare practitioner or a non-clinical peer support supervisor. In addition to providing wellness supports, the Peer Support Specialists will utilize his or her own experiences to act as a role model, teacher, and guide who both encourages and empowers the beneficiary to succeed in leading a healthy, productive lifestyle.

Personal Care

A range of assistance to enable HCBS beneficiaries to accomplish tasks that they would normally do for themselves if they did not have a disability. This assistance may take the form of hands-on assistance (actually performing a task for the person) or cueing to prompt the beneficiary to perform a task. Only those personal care services that take the form of verbal cueing may be delivered using telehealth or other electronic methods of service delivery. Personal care services may be provided on an episodic or on a continuing basis and may be provided by a home health aide, personal care attendant, or direct service worker. Personal care services may be delivered in an acute care hospital setting if these services are: described in the participant's person-centered service plan; provided to meet needs of the participant that are not met through the provision of hospital services; not a substitution for services that the hospital is obligated to provide through its conditions of participation or under federal or state law, or under another applicable requirement; and designed to ensure smooth transitions between acute care settings and home and community-based settings, and to preserve the participant's functional abilities.

Personal Emergency Response System (PERS)

PERS is an electronic device that enables HCBS beneficiaries to secure help in an emergency. The beneficiary may also wear a portable "help" button to allow for mobility. The system is connected to the beneficiary's phone and programmed to signal a response center once a "help" button is activated. The response center is staffed by trained professionals, as specified herein.

Prevocational Services

Services that provide learning and work experiences, including volunteer work, where the individual can develop general, non-job-task-specific strengths and skills that contribute to employability in paid employment in integrated community settings. Services are expected to occur over a defined period of time and with specific outcomes to be achieved, as determined by the individual and his/her service and supports planning team through an ongoing person-centered planning process, to be reviewed not less than annually or more frequently as requested by the individual. Individuals receiving prevocational services must have employment-related goals in their person-centered service plan; the general habilitation activities must be designed to support such employment goals. Competitive, integrated employment in the community for which an individual is compensated at or above the minimum wage, but not less than the customary wage and level of benefits paid by the employer for the same or similar work performed by individuals without disabilities is considered to be the successful outcome of prevocational services.

Prevocational services are intended to develop and teach general skills that lead to competitive and integrated employment including, but not limited to: ability to communicate effectively with supervisors, co-workers and customers; generally accepted community workplace conduct and dress; ability to follow directions; ability

to attend to tasks; workplace problem solving skills and strategies; general workplace safety and mobility training. Participation in prevocational services is not a required pre-requisite for individual or small group supported employment services provided under the HCBS. Pre-vocational settings will meet the HCBS settings requirements by 2022.

Private Duty Nursing

Individual and continuous care (in contrast to part time or intermittent care) provided by licensed nurses within the scope of state law, and as identified in the Individual Service Plan (ISP). These services are provided to a beneficiary at home.

Psychosocial Rehabilitation Services

Medical or remedial services recommended by a physician or other licensed practitioner of the healing arts under State law, for the maximum reduction of physical or mental disability and the restoration of maximum functional level. Specific services include the following:

- Restoration and maintenance of daily living skills (grooming, personal hygiene, cooking, nutrition, health and mental health education, medication management, money management and maintenance of the living environment);
- Social skills training in appropriate use of community services;
- Development of appropriate personal support networks, therapeutic recreational services (which are focused on therapeutic intervention rather than diversion); and,
- Telephone monitoring and counseling services.

The following are specifically excluded from payment for psychosocial rehabilitation services:

- Vocational services,
- Prevocational services,
- Supported employment services, and
- Room and board.

Respite

Service provided to beneficiaries, within parameters established by the state, who are unable to care for themselves that are furnished on a short-term basis because of the absence or need for relief of those persons who normally provide care for the beneficiary.

Remote Supports and Monitoring

Also known as surveillance monitoring, remote supports uphold independence by combining technology for service delivery with limited contact with trained staff

when the participant requires assistance. For individuals who may need 24-hour support but who do not always need hands-on support from an on-site staff person, this service will facilitate access to more support than would be possible if all the support were delivered in person. Access to more hours of support (delivered remotely) will allow the individual to remain in or move into a more independent living situation. In addition, supports such as live two-way communication will allow people to engage in community activities without in-person staff, with greater independence.

As part of the person-centered planning process, in consultation with the case manager, individuals will determine which services they choose to receive through remote supports rather than in-person supports. Provided, however, that the individual's choice of whether to receive remote supports rather than in-person supports is subject to any assessment of the individual's functional needs to protect the individual's health, safety, and well-being. In consultation with the case manager, where individuals choose to have a combination of in-person and remote supports for a particular service, the person-centered service plan will identify the times of day during which each will be provided to ensure that there is no overlap in delivery of the same service both remotely and in person.

Technology Services include: Motion sensing system; Live video feed and or audio feed; Web-based monitoring system; Sensor detection monitoring systems; and/or Another device that facilitates live two-way communication. All technology will need to be HIPAA-compliant. Radio frequency identification will be a component of some remote support equipment, used to track the equipment and thereby provide a location of an individual as well as to detect falls. Motion sensing system and sensor detection monitoring systems will only be used inside the home. Other technology services can be used inside or outside the home.

Participants will be given information to support their decision-making regarding whether to use remote supports. Services will be detailed in the individual's Individual Service Plan based on the individual's preferences and a risk assessment to determine if the service will meet the individual's support needs. In cases where an individual's needs could potentially be met by either a Personal Emergency Response System (PERS) or a Remote Support Technology Service, the Individual Service Plan will state which is being used to meet the particular need. An individual may use PERS to meet certain needs while using Remote Supports for others, but an individual may not receive both services to address the same need.

Any monitoring will only be deployed with the express agreement of the individual. If an individual resides with someone else, the other resident will also need to agree for the monitoring to be deployed. Individuals will have control over their devices and be able to turn off any remote support/monitoring technology. Cameras will not be placed in certain areas like bedrooms and bathrooms.

Providers will either be licensed Developmental Disabilities Organizations or a National Organization providing remote support services. Providers will offer 24-hour on-call services with real time audio/visual or other live 2-way communication and offer an in-person response if necessary to resolve a call.

Providers of Remote Supports will have check-ins with the participant on a bi-weekly basis for the first 2 months to ensure the individual is feeling safe and comfortable with the use of remote supports. These providers' check-ins will be either on-site or remote as documented in the individual's service plan. The individual's case manager will also check in on a monthly basis and ask questions regarding the supports the individual is receiving.

Service providers will need to ensure that there is a plan in place for individuals if there is a failure with the technology. They will need to ensure that individuals have back up batteries and that staff is available to go out in person when there is a power failure or have a plan in place with other unpaid supports to assist. These plans will be detailed in the individual's person-centered service plan.

Skilled Nursing

Services listed in the service plan that are within the scope of the State's Nurse Practice Act and are provided by a registered professional nurse, or licensed practical or vocational nurse under the supervision of a registered nurse, licensed to practice in the State.

Licensed Practical Nurse services provided under the supervision of a Registered Nurse. Licensed Practical Nurse Services are available to participants who require interventions beyond the scope of Certified Nursing Assistant (C.N.A.) duties. LPN services are provided in accordance with the Nurse Practice Act under the supervision of a registered nurse. This service is aimed at individuals who have achieved a measure of medical stability despite the need for chronic care nursing interventions. Individuals are assessed by a Registered Nurse (RN) in the EOHHS, Office of Community Programs.

Special Medical Equipment and Supplies

Specialized Medical Equipment and supplies to include: (a) devices, controls, or appliances, specified in the plan of care, that enable beneficiaries to increase their ability to perform activities of daily living; (b) devices, controls, or appliances that enable the beneficiary to perceive, control, or communicate with the environment in which they live; (c) items necessary for life support or to address physical conditions along with ancillary supplies and equipment necessary to the proper functioning of such items; (d) such other durable and non-durable medical equipment not available under the State Plan that is necessary to address beneficiary functional limitations;

and, necessary medical supplies not available under the State Plan. To maximize independence, includes remote services that enable appropriately licensed healthcare professionals to monitor through the telemedicine process certain aspects of a beneficiary's health while remaining at home or in a residential setting. Items reimbursed with HCBS funds are in addition to any medical equipment and supplies furnished under the State Plan and exclude those items that are not of direct medical or remedial benefit to the beneficiary. All items shall meet applicable standards of manufacture, design and installation. The services under the demonstration are limited to additional services not otherwise covered under the state plan, including EPSDT, but consistent with waiver objectives of avoiding institutionalization.

Supports for Consumer Direction (Supports Facilitation)

Focuses on empowering beneficiaries to define and direct their own personal assistance needs and services; guides and supports, rather than directs and manages, the beneficiary through the service planning and delivery process. The Facilitator counsels, facilitates, and assists in development of an ISP which includes both paid and unpaid services and supports designed to allow the beneficiary to live in the home and participate in the community. A back-up plan is also developed to assure that the needed assistance will be provided in the event that regular services identified in the Individual Service Plan are temporarily unavailable.\

Training and Counseling Services for Unpaid Caregivers

Training and counseling services for individuals who provide unpaid support, training, companionship or supervision to beneficiaries. For purposes of this service, individual is defined as any person, family member, neighbor, friend, companion, or co-worker who provides uncompensated care, training, guidance, companionship or support to a person served on the HCBS. This service may not be provided in order to train paid caregivers. Training includes instruction about treatment regimens and other services included in the service plan, use of equipment specified in the service plan, and includes updates as necessary to safely maintain the beneficiary at home. Counseling must be aimed at assisting the unpaid caregiver in meeting and managing the needs of the beneficiary. All training for individuals who provide unpaid support to the beneficiary must be included in the beneficiary's service plan.

Environmental Modifications (Home Accessibility Adaptations)

Those physical adaptations to the home of the member or the member's family as required by the member's service plan, that are necessary to ensure the health, welfare, and safety of the member or that enable the member to attain or retain capability for independence or self-care in the home and to avoid institutionalization, and are not covered or available under any other funding source. A completed home assessment by a specially trained and certified rehabilitation professional is also required. Such adaptations may include the installation of modular ramps, grab-bars, vertical platform lifts and interior stair lifts. Excluded are those adaptations that are of general utility, and are not of direct medical or remedial benefit to the member.

Excluded are any re-modeling, construction, or structural changes to the home, i.e. (changes in load bearing walls or structures) that would require a structural engineer, architect and/or certification by a building inspector. Adaptations that add to the total square footage of the home are excluded from this benefit. All adaptations shall be provided in accordance with applicable state or local building codes and prior approved on an individual basis by the EOHHS Office of Long Term Services and Supports is required. Items should be of a nature that they are transferable if a member moves from his/her place of residence.

Minor Environmental Modifications

Minor modifications to the home may include grab bars, versa frame (toilet safety frame), handheld shower and/or diverter valve, raised toilet seats, and other simple devices or appliances, such as eating utensils, transfer bath bench, shower chair, aids for personal care (e.g., reachers), and standing poles to improve home accessibility adaption, health, or safety.

PREVENTIVE SERVICES: Preventive services are provided to individuals that can demonstrate that the services will improve or maintain their abilities and/or prevent the need for more intensive services.

Assistive Technology

Assistive technology means an item, piece of equipment, service animal or product system, whether acquired commercially, modified, or customized, that is used to increase, maintain, or improve functional capabilities of beneficiaries, optimize their health and, promote independence and self-care. Assistive technology service means a service that directly assists a beneficiary in the selection, acquisition, or use of an assistive technology device. Assistive technology includes:

- The evaluation of the assistive technology needs of a beneficiary, including a functional evaluation of the impact of the provision of appropriate assistive technology and appropriate services to the beneficiary in the customary environment of the beneficiary;
- Services consisting of purchasing, leasing, or otherwise providing for the acquisition of assistive technology devices for beneficiaries;
- Services consisting of selecting, designing, fitting, customizing, adapting, applying, maintaining, repairing, or replacing assistive technology devices;
- Coordination and use of necessary therapies, interventions, or services with assistive technology devices, such as therapies, interventions, or services associated with other services in the service plan;
- Training or technical assistance for the beneficiary, or, where appropriate, the family members, guardians, advocates, or authorized representatives of the beneficiary; and
- Training or technical assistance for professionals or other individuals who provide services to, employ, or are otherwise substantially involved in the major life functions of beneficiaries.

Chore Services

Services needed to maintain the home in a clean, sanitary and safe environment. This service includes heavy household chores such as washing floors, windows and walls, tacking down loose rugs and tiles, moving heavy items of furniture in order to provide safe access and egress. These services are provided only when neither the beneficiary nor anyone else in the household is capable of performing or financially providing for them, and where no other relative, caregiver, landlord, community/volunteer agency, or third-party payor is capable of or responsible for their provision. In the case of rental property, the responsibility of the landlord, pursuant to the lease agreement, is examined prior to any authorization of service.

Community Transition Services

Community Transitions Services are non-recurring set-up expenses for individuals who are transitioning from an institutional or another provider-operated living arrangement to a living arrangement in a private residence where the person is directly responsible for his or her own living expenses. Allowable expenses are those necessary to enable a person to establish a basic household that do not constitute room and board and may include:

- One-time payment for security deposits that are required to obtain a lease on an apartment or home;
- One-time payment for the following services: Essential household furnishings and moving expense required to occupy and use a community domicile, including furniture, window coverings, food preparation items, and bed/bath linens,
- One-time payment for Set-up fees or deposits for utility or service access, including telephone, electricity, heating and water;
- One-time payment for services necessary for the individual's health and safety such as pest eradication and one-time cleaning prior to occupancy;
- One-time payment for moving expenses;
- Necessary home accessibility adaptations;
- Activities to assess need, arrange for and procure needed resources.
- Assistance with obtaining needed items for housing applications (e.g., assistance with obtaining and paying for a birth certificate or a state identification card, transportation to the local Social Security office);

Community Transition Services are furnished only to the extent that they are reasonable and necessary as determining through the service plan development process, clearly identified in the service plan and the person is unable to meet such expense or when the services cannot be obtained from other sources.

Homemaker

Services that consist of the performance of general household tasks (e.g., meal preparation and routine household care) provided by a qualified homemaker, when

the individual regularly responsible for these activities is temporarily absent or unable to manage the home and care for him/herself or others in the home.

Home Delivered Meals

The delivery of hot meals and shelf staples to the beneficiary's residence. Meals are available to an individual who is unable to care for his/her nutritional needs because of a functional dependency/disability and who requires this assistance to live in the community. Meals provided under this service will not constitute a full daily nutritional requirement. Meals must provide a minimum of one-third of the current recommended dietary allowance. Provision of home delivered meals will result in less assistance being authorized for meal preparation for individual beneficiaries, if applicable.

Non-Medical Transportation

Service is offered to enable HCBS beneficiaries to gain access to HCBS and other community services, activities and resources, as specified by the service plan. This service is available in addition to medical transportation and non-emergency medical transportation assured at 42 CFR §431.53 and 42 CFR §440.170(a) and does not replace emergency and non-emergency medical transportation. Transportation services to access HCBS are offered in accordance with the beneficiary's service plan, and when the beneficiary has no other means of transportation. Whenever possible, family, neighbors, friends, or community agencies which can provide this service without charge are utilized.

Medication Management/administration

Pharmacologic management including review of medication use, both current and historical, if indicated; evaluation of symptoms being treated, side effects and effectiveness of current medication(s), adjustment of medications if indicated, and prescription, provided by a medical professional practicing within the scope of his or her licensure.

Peer Supports

Peer Supports are provided by Peer Support Specialists that bring to the beneficiary a unique vantage point and the skills of lived experiences in either managing a health condition or disability, or in serving as the primary caregiver for a family member with a health condition or disability. This service is intended to provide individuals with a support system to develop and learn healthy living skills, to encourage personal responsibility and self-determination, to link individuals with the tools and education needed to promote their health and wellness (as well as the health and wellness of those that they are caring for, if applicable), and to teach the skills that are necessary to engage and communicate with providers and systems of care. Peer Support Specialists will work under the direction of a licensed healthcare practitioner or a non-clinical peer support supervisor. In addition to providing wellness supports, the Peer Support Specialists will utilize his or her own experiences to act as a role

model, teacher, and guide who both encourages and empowers the beneficiary to succeed in leading a healthy, productive lifestyle.

Personal Care

A range of assistance to enable HCBS beneficiaries to accomplish tasks that they would normally do for themselves if they did not have a disability. This assistance may take the form of hands-on assistance (actually performing a task for the person) or cuing to prompt the beneficiary to perform a task. Personal care services may be provided on an episodic or on a continuing basis and may be provided by a home health aide, personal care attendant, or direct service worker.

Personal Emergency Response System (PERS)

PERS is an electronic device that enables HCBS beneficiaries to secure help in an emergency. The beneficiary may also wear a portable "help" button to allow for mobility. The system is connected to the beneficiary's phone and programmed to signal a response center once a "help" button is activated. The response center is staffed by trained professionals, as specified herein.

Physical Therapy Evaluation and Services

Physical therapy evaluation for home accessibility appliances or devices by an individual with a state-approved licensing or certification. Preventive physical therapy services are available prior to surgery if evidence-based practice has demonstrated that the therapy will enhance recovery or reduce rehabilitation time.

Respite Services

Services provided to beneficiaries, within parameters established by the state, who are unable to care for themselves that are furnished on a short-term basis because of the absence or need for relief of those persons who normally provide t care for the beneficiary.

Skilled Nursing

Services listed in the service plan that are within the scope of the State's Nurse Practice Act and are provided by a registered professional nurse, or licensed practical or vocational nurse under the supervision of a registered nurse, licensed to practice in the State.

HABILITATIVE SERVICES

Residential Habilitation and Supports

Residential habilitation means individually tailored supports that assist with the acquisition, retention, or improvement in skills related to living in the community. These supports include adaptive skill development, assistance with activities of daily living, community inclusion, non-medical transportation to and from residential habilitation and support services, adult educational supports, social and leisure skill development, that assist the beneficiary to reside in the most integrated

setting appropriate to his/her needs. Residential habilitation also includes personal care and protective oversight and supervision.

Payment is not being made for the cost of room and board, including the cost of building maintenance, upkeep and improvement.

Integrated Day Habilitation and Supports

Provision of regularly scheduled activities in a non-residential setting, separate from the beneficiary's private residence or other residential living arrangement, such as assistance with acquisition, retention, or improvement in self-help, socialization and adaptive skills that enhance social development and develop skills in performing activities of daily living and community living.

Activities and environments are designed to foster the acquisition of skills, building positive social behavior and interpersonal competence, greater independence and personal choice. Services are furnished consistent with the beneficiary's person-centered plan. Meals provided as part of these services shall not constitute a "full nutritional regimen" (3 meals per day).

Day habilitation services focus on enabling the beneficiary to attain or maintain his or her maximum potential and shall be coordinated with any needed therapies in the individual's person-centered service plan, such as physical, occupational, or speech therapy. Settings will comply with the HCBS setting regulation by March 2022.

HOME AND COMMUNITY-BASED THERAPEUTIC SERVICES: Home and community-based therapeutic services are available to Medicaid beneficiaries at least 21 years of age who have at least one of the following:

- a chronic condition such as arthritis, asthma, diabetes, heart disease, special needs (such as autism) and diseases (such as cancer)
- a behavioral health diagnosis; a neurological diagnosis; or
- significant impairment in functioning level as determined by a validated screening tool.

Home Based Treatment

Home Based Treatment provides structure, supervision, guidance, and redirection for the individual with the goal of producing better outcomes such as: increasing language and communication skills; improving attention to tasks; generalizing pro-social behaviors; developing independent living skills; decreasing maladaptive behaviors; improving learning and problem-solving skills (e.g., organization, conflict resolution, and relaxation training); and adapting to transitions or housing acquisition and retention. Home Based Treatment prioritizes an individual's ability to remain or acquire stability in the community or at home, maintain or acquire activities of daily living, and participate in the community. Home Based Treatment encourages and promotes the practice of daily living skills by providing structure, supervision,

guidance, and redirection while engaging in cognitive, physical, and social activities. Goals and objectives are defined, written, and tied to specific methods of intervention and measurement of progress.

Life skill building services

Services designed to support an individual's ability to remain in the least restrictive setting and to participate in the community, encouraging activities of daily living by providing structure, supervision, guidance, direction, redirection and support while engaging in cognitive, physical and social activities based on developmental, intellectual and behavioral capability. These activities may include, but are not limited to, physical or verbal assistance with household maintenance tasks such as cooking, cleaning, or housing search assistance, and other tenancy support services.

Case Management

Services that assist participants in gaining access to needed HCBS, HBTS, and other State plan services, as well as medical, social, educational, and other services.

Treatment coordination

Treatment coordination consists of the coordination of an individual's services, including the maintenance of ongoing relationships with referral sources, the individual's medical home, referrals to tenancy support resources, and other supports. Treatment coordination requires consistent communication between members of the individual's care team and provider network, and incorporates input and participation from the individual, the individual's support system, Health Home, and appropriate family members. Treatment coordination also includes ongoing coordination during transitions of care.

Family Education and Support/Health Promotion

Support/treatment that is designed to assist individuals, sometimes in the context of their support system, to develop the skills and confidence to identify, seek out, and access resources to manage and mitigate the individual's condition(s), prevent the development of secondary or other chronic conditions, address engagement, promote optimal physical and behavioral health, and address and encourage activities related to health and wellness. This service will include the provision of health education, life support information, and community resources.

Coordinated Specialty Care

Coordinated Specialty Care (CSC) is a team-based, multi-element approach to treating First Episode Psychosis (FEP). Component interventions include assertive case management, nursing, wraparound services, individual or group psychotherapy, supported employment and education services, family education and support, peer support services, and medication treatment. The model includes a shared-decision making component, with the individual actively engaged in treatment and decision making. At its core, CSC is a collaborative, recovery-oriented approach involving

clients, treatment team members, and when applicable, relatives, as active participants. Services are highly coordinated with primary medical care, with a focus on optimizing a participant's overall mental and physical health. Services include the following:

- Psychotherapy
- Medication management
- Consultation with a psychiatric practitioner who will review medication history, allergies, medical issues, current symptoms, length and severity of symptoms, family history, and other questions to develop a full understanding of how the problem affects the individual.
- Medication outreach and reminders
- Active outreach to encourage medication compliance on a consistent basis with the intent of increasing adherence to medication regimen and overall health and wellness.
- Supported employment/supported education assists clients to begin and maintain employment or to enroll in and attend school. Activities include resume building, networking, on-site support and supervision when job is secured. Coordination of career plan.

Healthy Young Adult Supports

Healthy Young Adult Supports improves access to treatment and support services for youth and young adults, ages 16-25, who have a serious emotional disturbance (SED) or a serious mental illness (SMI). It is expected that this program will improve emotional and behavioral health functioning so that individuals can maximize their potential to assume adult roles and responsibilities and lead full and productive lives. The overall goal of Healthy Young Adult Supports is to provide developmentally suitable, culturally and linguistically competent services and supports to address serious mental disorders among youth 16 – 25 years of age. This will be accomplished by increasing awareness, screening and detection, outreach and engagement, referrals to treatment, coordination of care, and evidence-informed treatment. Services include the following:

- Screening to determine service level
- Mental health assessment
- Service coordination/Case/Care management
- Psychotherapy
- Medication Management
- Substance Use Disorder treatment
- Wraparound recovery and support services - intensive, holistic method of engaging with individuals with complex needs so that they can live in their homes and communities.
- Employment and training support - assists clients begin and maintain employment or to enroll in and attend school.

Seven Challenges

Seven Challenges is an evidence-based model/comprehensive counseling program for young people that incorporates work on alcohol and other drug problems. It is designed to motivate youth to evaluate their lives, consider changes they may wish to make, and then succeed in implementing the desired changes. It supports them in taking power over their own lives. Covered services include:

- Substance Use Disorder assessment and treatment
- Outreach efforts designed to build a trusting and therapeutic relationship which will support goal achievement, alternatives/ additions to traditional therapy such as journaling, completing activities in workbooks, and support with decision making skills.

ATTACHMENT C - Assessment and Coordination Organization

Rhode Island Long-Term Services and Supports Assessment and Coordination Organization

Summary:

The Assessment and Coordination Organization is not an actual organization. It is, instead, the organization of several current disparate *processes* that individuals and families use when seeking long-term services and supports. Today, if an individual needs institutional or community-based long-term care services, information about those services and ways to access the services is available from many different sources. These sources include: *The Point*, 211, community agencies, discharge planners, etc. Despite the well-meaning efforts of these entities, the complexity of Rhode Island's long-term care system does not always ensure the information is consistent, valid, or current.

The first goal of the Assessment and Coordination Organization is to ensure that the information about Rhode Island's publicly funded long-term services and supports system provided by all sources is accurate and timely. In order to achieve this goal, the state will seek to enter into interagency agreements with each entity identified as a primary information source.

Different agreements will be developed to reflect the unique relationship each primary information source has with the publicly-funded long-term services and supports system. For example, the State's Aging and Disability Resource Center, *The Point*, was created for the sole purpose of providing information, referrals, and general assistance for seniors, adults with disabilities, and their caregivers. The interagency agreement with *The Point* will reflect that role and will differ from the agreement that the state might enter with community agencies who view information and referral as secondary to their primary missions. Entities such as physician practices will be included in this primary information source group to the extent it is reasonable.

The interagency agreements will delineate the various ways the primary information source entity will receive information about the publicly funded long-term care systems and other health care programs, including electronic transmissions, written information, trainings, and workshops. The agreements will indicate ways to access state agency representatives if more information is needed. The agreements will also provide guidance on the second function of primary information source entities, appropriate referral of individuals to the next step.

Appropriate referral is the second goal of the Assessment and Coordination Organization. The state will ensure those primary information sources can direct persons to the appropriate next step – whether that next step is assessment for long-term care services; counseling for enrollment into an acute care managed care program; or referral to a specific state agency for more information. In order to achieve this goal, the state will develop a universal screening tool. This tool will be developed to capture information quickly that is necessary for the primary information source to determine the most appropriate placement and/or service referral.

Depending on the results of the initial screen, an individual may be referred to the following areas:

- Individuals determined to have a potential need for Medicaid funded long-term services and supports in a nursing facility or in the community will be referred to the Rhode Island Executive Office of Health and Human Services (EOHHS);
- Individuals determined to have a potential need for state-only funded long-term services and supports will be referred to the Rhode Island Division of Elderly Affairs (DEA);
- Individuals determined to have a potential need for services for the intellectually or developmentally disabled will be referred to the Rhode Island Department of Behavioral Healthcare, Developmental Disabilities and Hospitals (BHDDH);
- Individuals determined to have a potential need for long-term hospital services will be referred to Eleanor Slater Hospital, a state hospital that treats patients with acute and long term medical illnesses, as well as patients with psychiatric disorders;
- Individuals determined to have a potential need for behavioral health services for a child or for an adult will be referred to the Rhode Island Department of Children, Youth, and Families (DCYF) or BHDDH, respectively;
- Individuals who are seeking information for services other than long-term care will be referred to the appropriate place. For example, information on acute care managed care options is currently provided by the EOHHS Enrollment Hotline.

The assessment entities will be responsible for:

- Coordinating with the Medicaid eligibility staff;
- Conducting assessments;
- Accessing information needed to determine levels of care;
- Developing service plans with the active involvement of individuals and their families;
- Developing funding levels associated with care plans;
- Conducting periodic reviews of service plans;

- Coordinating services with care management entities (PACE; Rhody Health Partners);

Assessments and related functions are currently conducted by the state agencies (or their contracted entities) listed above. The development of care plans is one of the most important functions conducted by these entities or their contractors. The Assessment and Coordination Organization will ensure that these care plans are developed with the active participation of individuals and families. Full consumer participation will require information about the cost of services, utilization, and quality. One of the goals of the Waiver will be to provide the individual and his/her family with health reports that will indicate the amount that has been spent on the individual's services. This information will allow an individual to make more-informed choices about where his/her service plan dollars should be spent. These health reports will be generated through the CHOICES MMIS Module.

The Assessment and Coordination Organization's third goal is to ensure improved and increased communication between these assessment entities. For example, if an individual assessed by DHS for long-term community-based care is also found to have behavioral health needs, the individual's service plan will be developed in coordination with BHDDH. Communication between the assessment entities will occur through regular meetings and training sessions.

DHS, in close coordination with the other EOHHS agencies, will provide the administrative functions of the Assessment and Coordination Organization. These functions include: ensuring that the primary information entities and the assessment entities coordinate functions and communicate amongst each other and with each other; establishing training sessions and workshops; regularly tracking utilization; and monitoring outcomes to ensure that the Assessment and Coordination Organization's goals are met. On-going monitoring will enable the state to conduct interdisciplinary high-cost case reviews that could ultimately result in improvements to the system.

ATTACHMENT D - Level of Care Criteria

Long-term Care Level of Care Determination Process

Attached are: (1) A chart comparing the level of care determination process as determined by the section 1115a Comprehensive demonstration; and (2) A document describing the criteria for the highest level of care – with the waiver – developed by a workgroup that included members from the nursing home industry, consumer advocates, and health professionals. The state is in the process of developing similar criteria for the other two levels of care proposed in the Comprehensive demonstration.

Level of Care Determination Process: With the Comprehensive Waiver		
LTC Level of Care and Service Option Matrix		
Highest Nursing Home Level of Care (Access to Nursing Facilities and all Community-based Services)	Highest Hospital Level of Care (Access to Hospital, Group Homes, Residential Treatment Centers and all Community-based Services)	Highest ICF/IDD Level of Care (Access to ICFMR, Group Homes and all Community-based Services)
High Nursing Home Level of Care (Access to Core and Preventive Community-based Services)	High Hospital Level of Care (Access to Core and Preventive Community-based Services)	High ICF/IDD Level of Care (Access to Core and Preventive Community-based Services)

<p style="text-align: center;">Preventive Nursing Home Level of Care (Access to Preventive Community- based Services)</p>	<p style="text-align: center;">Preventive Hospital Level of Care (Access to Preventive Community- based Services)</p>	<p style="text-align: center;">Preventive ICF/IDD Level of Care (Access to Preventive Community-based Services)</p>
--	--	--

Institutional Level of Care Determination Policy: Nursing Facility

Highest Need Group

An individual who meets any of the following eligibility criteria shall be eligible and enrolled in the Highest Needs group:

1. An individual who requires extensive assistance or total dependence with at least one of the following Activities of Daily

Living (ADL):

Toilet use

Bed mobility

Eating

Transferring

AND who requires *at least* limited assistance with any other ADL.

OR

2. An individual who lacks awareness of needs or has moderate impairment with decision-making skills AND one of the following symptoms/conditions, which occurs frequently and is not easily altered:

Wandering

Verbally Aggressive Behavior

Resisting Care

Physically Aggressive Behavior

Behavioral Symptoms requiring extensive supervision

OR

3. An individual who has at least one of the following conditions or treatments that requires skilled nursing assessment, monitoring, and care on a daily basis:

Stage 3 or 4 Skin Ulcers

Ventilator/Respirator

IV Medications

Naso-gastric Tube Feeding

End Stage Disease

Parenteral Feedings

2nd or 3rd Degree Burns

Suctioning

Gait evaluation and training

OR

4. An individual who has an unstable medical, behavioral, or psychiatric condition(s), or who has a chronic or recurring condition that requires skilled nursing assessment, monitoring, and care on a daily basis related to, but not limited to, at least one of the following:

Dehydration	Internal Bleeding
Aphasia	Transfusions
Vomiting	Wound Care
Quadriplegia	Aspirations
Chemotherapy	Oxygen
Septicemia	Pneumonia
Cerebral Palsy	Dialysis
Respiratory Therapy	Multiple Sclerosis
Open Lesions	Tracheotomy
Radiation Therapy	Gastric Tube Feeding
Behavioral or Psychiatric conditions that prevent recovery	

OR

5.

An individual who does not meet at least one of the above criteria may be enrolled in the Highest Needs Group when the Executive Office of Health and Human Services determines that the individual has a critical need for long-term care services due to special circumstances that may adversely affect the individual's health and safety.*

Definitions

- Extensive Assistance (Talk, Touch, and Lift): Individual performs part of the activity, but caregiver provides physical assistance to lift, move, or shift individual.
- Total Dependence (All Action by Caregiver): Individual does not participate in any part of the activity
- Limited Assistance (Talk and Touch): Individual highly involved in the activity, but received physical guided assistance and no lifting of any part of the individual.

High Need Group

An individual who meets any of the following eligibility criteria shall be eligible and enrolled in the High Needs group:

1. An individual who requires at least limited assistance on a daily basis with at least two of the following ADLs:

Bathing/Personal Hygiene	Dressing
Eating	Toilet Use
Walking/Transfers	

2. An individual who requires skilled teaching on a daily basis to regain control of, or function with, at least one of the following:

Gait training	Speech
Range of motion	Bowel or bladder training

3. An individual who has impaired decision-making skills that requires constant or frequent direction to perform at least one of the following:

Bathing	Dressing
Eating	Toilet Use
Transferring	Personal hygiene

4. An individual who exhibits a need for a structured therapeutic environment, supportive interventions, and/or medical management to maintain health and safety.

Preventive Need Group

An individual who meets the preventive service criteria shall be eligible for enrollment in the preventive needs group. Preventive care services are designed to promote and preserve health and safety or to alleviate symptoms to address functional limitations. Preventive services may avert or avoid institutionalization. An individual in need of the following services, and who can demonstrate that these services will improve or maintain abilities and/or prevent the need for more intensive services, will be enrolled in the preventive need group.

1. Homemaker Services: General household tasks including basic home and household assistance for a health condition or to address functional limitations. The services include meal preparation, essential shopping, laundry, and cleaning for an individual without a social support system able to perform these services for him/her. These services may be performed and covered on a short term basis after an individual is discharged from an institution and is not capable of performing these activities himself/herself.

2. Minor Environmental Modifications: Minor modifications to the home may include grab bars, versa frame (toilet safety frame), handheld shower and/or diverter valve, raised toilet seats, and other simple devices or appliances such as eating utensils, transfer bath bench, shower chair, aids for personal care (e.g., reachers) and standing poles to improve home accessibility adaption, health, or safety.

3. Physical Therapy Evaluation and Services: Physical therapy evaluation for home accessibility appliances or devices by an individual with a state-approved licensing or certification. Preventive physical therapy services are available prior to surgery if

evidence-based practice has demonstrated that the therapy will enhance recovery or reduce rehabilitation time.

4. **Respite Services:** Temporary caregiving services given to an individual unable to care for himself/herself that is furnished on a short-term basis because of the absence or need for relief of those persons normally providing the care for the participant. Respite services will be recommended and approved by EOHHS, Office of Long Term Services and Supports.

5. **Personal Care Services:** Personal Care Services provide direct hands on support in the home or community to an individual in performing Activity of Daily Living (ADL) tasks that he/she is functionally unable to complete independently due to disability. Personal Care Services may be provided to an individual by:

a. A Certified Nursing Assistant which is employed under a State licensed home care agency and meets such standards of education and training as are established by the State for the provision of these activities.

Assessments and Reassessments

1. An individual enrolled in the High Needs group who, at reassessment or a change in status, meets any of the Highest Needs eligibility criteria shall be enrolled in the Highest Needs group.
2. Re-Evaluation of Needs for an individual in the Highest Needs Group:

When the Department of Human Services determines that an individual is admitted to a nursing facility or meets the Highest Needs Group level of care, the Nurse Consultant designates those instances in which the individual's medical information indicates the possibility of significant functional and/or medical improvement within two (2) months.

Notification is sent to the individual, to his/her authorized representative, and to the Nursing Facility that a Nursing Facility level of care has been approved, but functional and medical status will be reviewed again in thirty (30) to sixty (60) days. At the time of the review, the Nurse Consultant must first confirm that the individual remains a resident of the nursing facility. For an individual remaining in a nursing facility, the Nurse Consultant reviews the most recent Minimum Data Set and requests any additional information necessary to make one of the following determinations:

- a. The individual no longer meets a Highest Needs Group level of care. In this instance, the Long Term Care Office is notified of the Highest Needs Group Level of Care denial, and the Long Term Care Unit sends

a discontinuance notice to the individual, to his/her authorized representative if one has been designated, and to the nursing facility. Prior to being sent a discontinuance notice, the individual will be evaluated to determine if the individual qualifies for the High Needs group.

b. The individual continues to meet the appropriate level of care, and no action is required.

3. An individual residing in the community who is in the Highest and High groups will have, at a minimum, an annual assessment.

DD/ID Needs-Based Service Tier Classifications and Options		
Tier	Service Options	Available Supports
Tier D and E (Highest): <i>Extraordinary Needs</i>	<ul style="list-style-type: none"> • Living with family/caregiver • Independent Living • Shared Living • Community Support Residence • Group Home/Specialized Group Home 	<ul style="list-style-type: none"> • Community Residential Support and/or access to overnight support services • Integrated Employment Supports • Integrated Community and/or Day supports • Transportation
Tier C (Highest): <i>Significant Needs</i>	<ul style="list-style-type: none"> • Living with family/caregiver • Independent Living • Shared Living • Community Support Residence • Group Home 	<ul style="list-style-type: none"> • Community Residential Support and/or access to overnight support services • Integrated Employment Supports • Integrated Community and/or Day supports • Transportation
Tier B (High): <i>Moderate Needs</i>	<ul style="list-style-type: none"> • Living with family/ caregiver • Independent Living • Community Support Residence • Shared Living • *Group Home 	<ul style="list-style-type: none"> • Community Residential Support and/or access to overnight support services • Integrated Employment supports • Integrated Community and/or Day supports • Transportation

Tier A (High): Mild Needs	<ul style="list-style-type: none"> • Living with Family/Caregiver • Independent Living • Community Support Residence • **Shared Living • *Group Home 	<ul style="list-style-type: none"> • Community Residential Support and/or Access to overnight support services • Integrated Employment supports • Integrated Community and/or Day Supports • Transportation
<p>* Tier A or B individuals will have access to residential services in a group home if they meet at least one defined exception.</p> <p>** Tier A will have access to Shared Living services if they meet at least one defined exception.</p>		

Description of Level of Care (LOC) for Intellectual/Developmental Disability Services

Tier A (High): Qualifying Disability with mild support needs. Adults at this level are assessed as having mild support needs. These individuals are capable of managing many aspects of their lives with limited supports and services. These individuals do not receive 24/7 paid supports and have a significant amount of time spent alone and/or with natural unpaid supports and engaging in the community with limited supports and services.

Tier B (High): Qualifying Disability with moderate support needs. Adults at this level require more supports than Tier A, but also receive daily support needs but not 24/7 paid supports. Although these individuals require more support to meet personal needs than those in Tier A, their support needs are still generally minimal in many life areas.

Tier C (High): Qualifying Disability with identified medical/behavioral needs requiring significant supports. Adults at this Tier have profound support needs and are identified with medical/behavioral needs requiring significant supports. Some time may be spent alone, engaging independently in certain community activities and/or with unpaid natural supports.

Tier D (Highest): Qualifying Disability with extraordinary medical issues requiring significant medical supports. Adults at this Tier include persons with the most extensive/complex medical support needs that require nurse

management in order to minimize medical risk factors. Maximum assistance with activities of daily living is required to meet their extensive physical support needs and personal hygiene; including lifting/transferring and positioning. Feeding tubes and other feeding supports (e.g. aspiration risk management), oxygen therapy or breathing treatments, suctioning, and seizure management are common as well. Some of these individuals may be medically unstable or receiving hospice services.

Tier E (Highest): Qualifying Disability with extraordinary behavioral issues requiring significant behavioral supports. Adults with extraordinary behavioral issues requiring significant behavioral supports. Adults at this Tier include persons with the most extraordinary behavior support needs. All of these individuals require one-to-one supervision for at least a significant portion of each day. Many individuals in this Tier have a mental health condition in addition to a developmental disability. These individuals would pose a safety risk to themselves and/or the community without continuous support.

ATTACHMENT E - Quarterly and Annual Progress Report Template and Instructions

As stated in Special Terms and Conditions STC 120 the state must submit quarterly progress reports to CMS. The purpose of the quarterly report is to inform CMS of significant demonstration activity from the time of approval through completion of the demonstration. The first, second and third quarter reports are due to CMS 60 days after the end of each quarter. The annual report, which contains the fourth quarter data, will be due no later than ninety (90) calendar days) following the end of the demonstration year.

The following report template is intended as a framework, and can be modified when CMS and the state agree to the modification. A complete quarterly progress report must include the budget neutrality monitoring workbook.

I. Narrative Report Format

Title Line One - _____ (*Name of Individual State Program*)

Title Line Two - Section 1115 Quarterly Report

Demonstration/Quarter Reporting Period:

Example:

Demonstration Year: year # and dates

II. Introduction

Describe the goal of the demonstration, what service it provides, and key dates of approval/operation. (*This should be the same for each report.*)

III. Enrollment Information

Complete the following table that outlines all enrollment activity under the demonstration. Indicate “N/A” where appropriate. If there was no activity under a particular enrollment category, the state should indicate that by placing “0” in the appropriate cell.

Note: Enrollment counts should be participant counts, not participant months.

Population Groups (as hard coded in the CMS-64)	Number of Current Enrollees (to date)*	Number of Enrollees That Lost Eligibility in Current Quarter**
Budget Population 1: ABD no TPL		
Budget Population 2: ABD TPL		
Budget Population 3: RItE Care		
Budget Population 4: CSHCN		
Budget Population 5: EFP		
Budget Population 6: Pregnant Expansion		
Budget Population 7: CHIP Children		
Budget Population 8: Substitute care		
Budget Population 9: CSHCN Alt		
Budget Population 10: Elders 65 and over		
Budget Population 11, 12, 13: 217-like group		
Budget Population 15: AD Risk for LTC		
Budget Population 16: Adult Mental Unins.		
Budget Population 17: Youth Risk Medic		
Budget Population 18: HIV		
Budget Population 19: AD Non-working		
Budget Population 20: Alzheimer adults		
Budget Population 21: Beckett aged out		
Budget Population 22: New Adult Group		
Budget Population 23: DSHPs		

***Current Enrollees:**

Number of current enrollees in the eligibility system as of the last day of the month in the quarter on the basis of Medicaid eligibility.

****Number of Enrollees That Lost Eligibility in the Current Quarter:**

Number of enrollees no longer in the eligibility system as of the last day of the month in the quarter on the basis of Medicaid eligibility.

If the demonstration design includes a self-direction component, complete the following two sections:

IV. “New”-to-“Continuing” Ratio

Report the ratio of new-to-continuing Medicaid personal care service clients at the close of the quarter.

V. Special Purchases

Identify special purchases approved during this quarter (by category or by type). Examples of “special purchases” have been provided below.

# of Units/ Items	Item or Service	161. Description of Item/Service (if not self-explanatory)	Total Cost
10	Microwaves		\$1,000.89
1	Water Therapy	Aqua massage therapy that will assist individual with motor function.	\$369.00
CUMULATIVE TOTAL			\$1,369.89

VI. Programmatic Demonstration Activities, including but not limited to the Oral Health program, HSTP, etc.

Summarize outreach activities and/or promising practices for the current quarter. Identify all significant program developments/issues/problems that have occurred in the current quarter/demonstration year.

VII. Financial/Budget Neutrality Developments/Allotment Neutrality Developments/Issues

Identify all significant developments/issues/problems with financial accounting, budget neutrality, CMS-64 reporting for the current quarter, and, if appropriate, allotment neutrality and CMS-21 reporting for the current quarter. Identify the State’s actions to address these issues. The state is still responsible for submitting the proper CMS-64 reports and Budget Neutrality workbooks as outlined in STCs.

VIII. Consumer Issues

Summarize the types of complaints or problems enrollees identified about the program in the current quarter. Include any trends discovered, the resolution of complaints, and any actions taken or to be taken to prevent other occurrences.

IX. Marketplace Subsidy Program Participation

Complete the following table that displays enrollment and cost information pertaining to the Marketplace Subsidy Program. Include a summary and explanation of any trends discovered.

<u>Month</u>	<u>Number of Marketplace Subsidy Program Enrollees</u>	<u>Change in Marketplace Subsidy Program Enrollment from Prior Month</u>	<u>Average Size of Marketplace Subsidy Received by Enrollee</u>	<u>Projected Costs</u>	<u>Actual Costs</u>
<u>January</u>					
<u>February</u>					
<u>March</u>					
<u>April</u>					
<u>May</u>					
<u>June</u>					
<u>July</u>					
<u>August</u>					
<u>September</u>					
<u>October</u>					
<u>November</u>					
<u>December</u>					

X. Evaluation and Quality Assurance Monitoring Activities

Identify, describe, and report activities that occur within the demonstration specifically focusing on the development of the demonstration and quality assurance designs. Activities can include information regarding updates on the evaluation design, evaluator information provided to the state, etc. within the demonstration evaluation and quality assurance activities in the reported quarter.

XI. Enclosures/Attachments

Identify by title any attachments along with a brief description of the information contained in the document.

XII. State Contact(s)

Identify individuals by name, title, telephone, fax, and address so that CMS may contact individuals directly with any questions.

XIII. Date Submitted to CMS

Enter the date submitted to CMS in the following format: (mm/dd/yyyy).

The state may add additional program headings as applicable.

ATTACHMENT F – HCBS Evidentiary Review Guidance

HCBS Quality Review Worksheet

I. Level of Care (LOC) Determination	
<i>The state demonstrates that it implements the processes and instrument(s) in its approved waiver for evaluating/reevaluating an applicant’s/waiver participant’s LOC consistent with care provided in a hospital, nursing facility, or intermediate care facility for individuals with intellectual disability.</i>	
Sub Assurances	CMS Expectations
An evaluation for level of care is provided to all applicants for whom there is reasonable indication that services may be needed in the future.	State submits evidence that it has reviewed applicant files to verify that individual level of care evaluations are conducted.
The level of care of enrolled participants is reevaluated at least annually or as specified in its approved waiver.	State must conduct at least annually reevaluations of level of care or as specified in the approved waiver.
The process and instruments described in the approved waiver are applied appropriately and according to the approved description to determine participant level of care.	State submits that it regularly reviews participant files to verify that the instrument described in approved waive is used in all level of care redeterminations, the person(s) who implement level of care determinations are those specified in approved waiver, and the process/instruments are applied appropriately.

II. Service Plans	
<i>The state demonstrates it has designed and implemented an effective system of reviewing the adequacy of service plans for waiver participants.</i>	
Sub Assurances	CMS Expectations
Service plans address all participants' assessed needs (including health and safety risk factors) and personal goals, either by waiver services or through other means.	State demonstrates that service plans are reviewed at least annually to assure that all of participant needs are addressed and preferences considered.
The state monitors service plan development in accordance with its policies and procedures.	State must develop service plans according to policies and procedures.
Service plans are updated/revised at least annually or when warranted by changes in the waiver participant's needs.	State submits evidence of its monitoring process for service plan update/revision including service plan updates taken when service plans were not updated/revised according to policies and procedures.
Services are delivered in accordance with the service plan, including the type, scope, amount, and frequency specified in the service plan.	State submits evidence of the results of its monitoring process for ensuring the services identified in the service plan are implemented.
Participants are afforded choice: (1) Between waiver services and institutional care; and, (2) Between/among waiver services and providers.	State must still offer choice and a mechanism for ensuring the services identified in the service plan are implemented.

III. Certified Providers	
<i>The state demonstrates that it has designed and implemented an adequate system for assuring that all waiver services are provided by certified providers.</i>	
Sub Assurances	CMS Expectations
The state verifies that providers initially and continually meet required licensure and/or certification standards and adhere to other state standards prior to their furnishing waiver service.	State provides documentation of periodic review by licensing/certification entity.
The state monitors non-licensed/non-certified providers to assure adherence to waiver requirements.	State provides documentation that non-licensed/non-certified providers are monitored on a periodic basis sufficient to provide protections to waiver participants.

<p>The state implements its policies and procedures for verifying that provider training is conducted in accordance with state requirements and the approved waiver.</p>	<p>State provides documentation of monitoring of training and actions it has taken when providers have not met requirements (e.g., technical assistance, training)</p>
--	--

IV. Health and Welfare	
<i>The state demonstrates it has designed and implemented an effective system for assuring waiver participant health and welfare.</i>	
Sub Assurances	CMS Expectations
The State demonstrates that an incident management system is in place that effectively resolves those incidents and prevents further similar incidents to the extent possible.	State must establish a critical incident management system, which investigates, substantiates, and provides recommended actions to protect health and welfare
The State policies and procedures for the use or prohibition of restrictive interventions (including restraints and seclusion) are followed.	State must develop policies and procedures that address the use or prohibition of restrictive interventions.
The State establishes overall health care standards and monitors those standards based on the responsibility of the service provider as stated in the approved waiver.	State submits evidence that on an ongoing basis, it monitors services providers to ensure overall healthcare standards are as stated in the approved waiver.
The state, on an ongoing basis, identifies, address, and seeks to prevent the occurrence of abuse, neglect, exploitation and unexplained death.	State demonstrates that, on an ongoing basis, abuse, neglect, exploitation and unexplained death are identified, appropriate actions have been taken when the health or welfare of a participant has not been safeguarded, and an analysis is conducted of abuse, neglect and exploitation trends and unexplained death trends and strategies it has implemented for prevention.

V. Administrative Authority	
<i>The state demonstrates that it retains ultimate administrative authority over the waiver program and that its administration of the waiver program is consistent with the approved waiver application.</i>	
Sub Assurances	CMS Expectations
The state Medicaid agency retains the ultimate administrative authority and responsibility for the operation of the waiver program by exercising oversight of the performance of waiver functions by other state and local/regional non-state agencies (if appropriate) and contracted entities.	State submits evidence of its monitoring of all delegated functions, and implementation of policies/procedures related to its administrative authority over the waiver program, including: memoranda of agreements, description of roles and responsibilities relative to program operations, monitoring, and remediation or system improvements instituted when

	problems are identified in the operation of the waiver program.
--	---

VI. Financial Accountability	
<i>The state demonstrates that it has designed and implemented an adequate system for assuring financial accountability of the waiver program.</i>	
Sub Assurance	CMS Expectations
State financial oversight exists to assure that claims are coded and paid for in accordance with the reimbursement methodology specified in the approved waiver.	<ul style="list-style-type: none"> • State submits results of its financial monitoring process for verifying maintenance of appropriate financial records as specified in the approved waiver. • State submits results of its review of waiver participant claims to verify that they are coded and paid in accordance with the waiver reimbursement methodology. • State demonstrates that interviews with state staff and providers are periodically conducted to verify that any identified financial irregularities are addressed. • State demonstrates that site visits are conducted with providers to verify that they maintain financial records according to provider agreement/contracts.

The state may submit summary reports for each HCBS sub assurance outline above based on a significant sample of any single or combined method or source of evidence as follows:

- Record reviews, on-site
- Record reviews, off-site
- Training verification records
- On-site observations, interviews, monitoring
- Analyzed collected data (including surveys, focus group, interviews, etc.)
- Trends, remediation actions proposed/taken
- Provider performance monitoring
- Operating agency performance monitoring
- Staff observation/opinion

- Participant/family observation/opinion
- Critical events and incident reports
- Mortality reviews
- Program logs
- Medication administration data reports, logs
- Financial records (including expenditures)
- Financial audits
- Meeting minutes
- Presentation of policies or procedures
- Reports to state Medicaid agency or delegated administrative functions
- Other

Attachment G: Reserved for Description of Healthy Behaviors Incentives Program

Attachment H: Accountable Entity Total Cost of Care Requirements

Table of Contents

A. TCOC Definition	3
B. TCOC Methodology Goals	3
C. General Requirements for Program Participation	4
1. Minimum Membership and Population Size	
2. State/MCO Capitation Arrangement	
3. Exclusivity of Approved TCOC Methodologies	
4. Other Approved Alternative Payment Methodologies for LTSS Providers	
5. Attribution	
D. TCOC Methodology: Required Elements for Comprehensive AEs	5
1. Defining a Historical Base	
2. Required Adjustments to the Historical Base	
3. TCOC Expenditure Target for the Performance Period	
4. Actual Expenditures for the Performance Period	
5. Shared Savings/(Loss) Pool Calculations	
6. AE Share of Savings/(Loss) Pool	
7. Required Progression to Risk Based Arrangements	
E. TCOC Methodology: Required Elements for Specialized LTSS AEs	11
1. Defining a Historical Base	
2. Required Adjustments to the Historical Base	
3. TCOC Expenditure Target for the Performance Period	
4. Actual Expenditures for the Performance Period	
5. Shared Savings/(Loss) Pool Calculations	
6. AE Share of Savings/(Loss) Pool	
7. Required Progression to Risk Based Arrangements	
F. TCOC Development and Approval Process	17
G. Other APMs for Specialized LTSS AEs	18
H. Comprehensive AE TCOC Methodology Example	20
I. Specialized LTSS AE TCOC Methodology Example	22

Attachments

- **Attachment A**
Services Included in Specialized LTSS AE TCOC Analyses
- **Attachment B**
Quality Framework and Methodology for Comprehensive and Specialized LTSS
Accountable Entities

TCOC Definition

The total cost of care (TCOC) calculation is a fundamental element in any shared savings and/or risk arrangement. Most fundamentally, it includes a historical baseline or benchmark cost of care specifically tied to an Accountable Entity's (AE) attributed population projected forward to the performance period. Actual costs during the performance period are then compared to those projections to identify a potential shared savings or risk pool, depending on the terms of the arrangement.

Effective TCOC methodologies provide an incentive for AEs to invest in care management and other appropriate services to address the needs of their attributed populations and reduce duplication of services. For populations with long-term care needs, effective TCOC methodologies also provide incentives for AEs to help beneficiaries live successfully in the community and reduce use of institutional services. In doing so, AEs will be able to improve outcomes, lower overall healthcare costs, and be able to earn savings. Shared savings distributions must be based on well-defined quality and outcomes metrics.

TCOC Methodology Goals

These TCOC guidelines have been designed to support **Meaningful Performance Measurement**, thereby creating financial incentives to reduce costs and improve quality. In order to accomplish meaningful performance measurement, this methodology must incorporate the following:

- **Provide opportunity for a sustainable business model**
Create ongoing opportunity for effective AEs by: (1) recognizing efficient historical performers; (2) allowing for shared savings to be retained for system investment; (3) creating greater financial incentives for being inside the AE program than for being outside; (4) identifying clinical pathways for complex co-occurring chronic conditions that are prevalent among Medicaid high utilizers; (5) addressing social determinants (e.g., housing, food security, access to non-medical transportation) that impact health outcomes and costs; and (6) implementing effective interventions to help elders and adults with disabilities remain in the community.
- **Be fiscally responsible for all participating parties**
Adequately protect the solvency of the AEs and managed care organizations (MCOs) and the financial interests of the RI Medicaid Program.
- **Specifically recognize and address the challenge of small populations**
Implement mitigation strategies to minimize the impact of small numbers, given the state's small size and particularly related to LTSS.
- **Incorporate quality metrics related to increased access and improved member outcomes**
Have reporting mechanisms for MCOs and AEs that allow for timely data exchange and performance improvement to ensure access and quality.
- **Define and establish a progression toward meaningful AE risk**

- **Establish consistent core components of the TCOC methodology while still allowing some innovation and flexibility**
Balance these competing goals. Allow for some variation in TCOC methodology within uniform state guidelines/criteria, with recognition of the importance of alignment in the methodology for the managed care and fee-for-service populations attributed to specialized LTSS AEs.

General Requirements for Program Participants

1. Minimum Membership and Population Size

For comprehensive AEs, MCOs may utilize TCOC-based payment models only with AEs which have at least 5,000 attributed Medicaid members, across all MCOs. For specialized LTSS AEs, there must be at least 500 attributed lives in Medicaid managed care and/or Medicaid fee-for-service.

2. State/MCO Capitation Arrangement

The MCO retains the base contract with the State; the MCO medical capitation will be adjusted for savings/risk associated with the program as described in the State/MCO contract. This does not preclude MCOs from creating value-based purchasing arrangements with non-AE providers; however, those contracts would still be subject to the State gain-share and would not be included in the State's assessment of the MCO's value-based payment performance standards related to AEs.

3. Exclusivity of Approved TCOC Methodologies

MCO TCOC arrangements shall supersede and be exclusive of any other TCOC-related shared savings arrangements with an AE or any of its constituent providers for Medicaid members.

4. Other Approved Alternative Payment Methodologies for LTSS Providers

The MCO and Medicaid fee-for-service may also implement other approved alternative payment methodologies (APMs) (as described in Section G), in addition to TCOC arrangements, for providers in specialized LTSS AEs. Participation in those APMs is voluntary for providers.

5. Attribution

AE specific historic base data must be based on the AE's attributed lives for a given period, in accordance with EOHHS defined attribution requirements, as defined separately. TCOC performance period data must account for and be aligned with the list of attributed members MCOs are required to generate on a monthly basis, as described in the attribution requirements.

TCOC Methodology: Required Elements for Comprehensive AEs

MCO TCOC arrangements with comprehensive AEs must meet the following requirements, listed here and described in more detail below:

1. Defining a Historical Base
2. Required Adjustments to the Historical Base
3. TCOC Expenditure Target for the Performance Period
4. Actual Expenditures for the Performance Period
5. Shared Savings/(Loss) Pool Calculations
6. AE Share of Shared Savings/(Loss) Pool
7. Required Progression to Risk Based Arrangements

1. Defining a Historical Base

a. AE-Specific Historical Cost Data

The TCOC historical base shall include three years of AE-specific historical cost data with equal weighting applied to each year. MCOs are strongly encouraged to use three years of historic data in creating the benchmark to stabilize the historic base; at a minimum, all existing AE experience must be utilized.

b. Covered Services

TCOC methodologies shall include all costs associated with covered services that are included in EOHHS's contract with MCOs for the performance year, with the following clarifications/exceptions. Any further adjustments to covered services outside of those listed below must be requested in writing and pre-approved by EOHHS prior to MCO-AE contract execution for the affected contractual performance year:

- I. Exclude services currently covered under stop-loss provisions between EOHHS and the MCO, as outlined below:
 - Long-term care in an intermediate or skilled facility in excess of 30 days.
 - Costs associated with the transplant of a bodily organ. Includes costs incurred from the date of admission through the date of discharge associated with the specific hospital stay in which an organ is implanted. The AE TCOC calculation will include all costs up to the transplant of a bodily organ.
 - Early Intervention Services in excess of \$5,000 for an individual.
 - Hepatitis C Pharmacy Costs: Costs in excess of the per member per month level as set forth in the *Provisions for Stop Loss Claiming for Pharmacy Expenditure in Treatment of Enrollees with Hepatitis C*.
- II. Exclude HSTP performance incentive payments and CTC payments.
- III. Include and define any other infrastructure payments made by MCOs to AEs and AE-affiliated providers.

c. Mitigation of Impact of Outliers: Claims threshold for high cost claims

TCOC expenditure data shall be adjusted to exclude costs in excess of \$100,000 per member per year. However, TCOC expenditures must include 10% of any annualized spending per member above the truncation threshold.

d. Adjusting for a Changing Risk Profile

To account for possible changes in the risk profile of an AE's attributed patient population over the historical base years, the MCO shall employ one of the following two risk adjustment methodologies:

- **Risk Adjustment Software**

MCOs may apply a clinical risk adjustment software. Under such an approach, risk calculations and any adjustments shall be applied at the total population and not the EOHHS rate cell level. The TCOC methodology must describe the MCO's risk-adjustment method including underlying software parameters set by the MCO. Such information shall also be disclosed to contracting AEs.

- **Rate Cell Calculations**

MCOs may use the population mix by rate cell, for each period, to adjust for changes in this population mix over time.

Note that if an MCO chooses to utilize a risk adjustment software, the MCO must provide a detailed description of the specific software/methodology applied, including the underlying parameters set by the MCO. Note that this is an interim solution, as the state intends to implement a standardized risk adjustment methodology over the course of this program. Should the MCO wish to further adjust for a changing risk profile using clinical and social risk factor data exogenous to the risk adjustment methodologies described above, it may do so after review and approval by EOHHS.

e. Historical Base with Required Cost Trend Assumptions

When projecting (or trending) historical costs forward into the performance year, TCOC methodologies shall appropriately account for trends in the medical component of capitation rates being paid to MCOs by EOHHS. Unless otherwise approved by EOHHS, trends assigned to TCOC baselines shall not exceed the final cumulative trends to the medical portion of rates contained in the EOHHS data books by cap cell. The trends may be applied by the MCO to the AE in aggregate based on either the AE's or the MCO's member mix.

2. Required Adjustments to the Historical Base

In order to prospectively establish an AE's TCOC Expenditure Target, the MCO must apply the following adjustments to the historical base. Note that no additional adjustments are allowed without prior approval from EOHHS.

a. Adjustment for Prior Year Savings

The TCOC Expenditure Target must include an upward adjustment equal to an AE's share of prior year savings, after adjustment for quality performance, so that AEs have an opportunity to retain a portion of generated savings year over year. This adjustment must not exceed 2% of the unadjusted TCOC Expenditure Target.

b. Adjustment for Historically Low-Cost AEs

Should any AE have three years of historical cost data demonstrating that risk-adjusted per capita spending for the AE's historically attributed patient population for TCOC

covered services was significantly below the MCO average (statistically significant at $p \leq .05$), the MCO may adjust that AE's TCOC Expenditure Target upward by up to the percentage by which the TCOC fell below MCO average spending for the assessed historical time period. This adjustment must not exceed 2% of the unadjusted TCOC Expenditure Target. This adjustment shall not be applied to entities with a historically attributed patient population for TCOC covered services that was significantly above the MCO average.

3. TCOC Expenditure Target for the Performance Period

Once an AE-specific adjusted historical base is established, this base must be trended forward into the performance period to create an AE-specific TCOC Expenditure Target.

TCOC methodologies shall be based on a performance time period of 12 months aligned with the state fiscal year. Initial contractual performance time periods may extend longer than 12 months if necessary.

a. Required Cost Trend Assumptions

The adjusted historical base must be cost trended to the performance year according to the cost trend assumptions described in Section D.1.e of this document.

b. Final Target Adjusted for Changes in the Attributed Population's Risk Profile

The MCO must apply a risk adjustment methodology to assess any changes in an attributed population's risk profile from the risk-adjusted historical base to the contractual performance period. This methodology must be consistent with the risk adjustment methodology used in developing the adjusted historical base as described in Section D.1.d of this document.

4. Actual Expenditures for the Performance Period

a. Calculate Actual Expenditures Consistent with the Historical Base Methodology

Actual Expenditures for the Performance Period must be calculated consistent with the historical base methodology as described in Sections D.1.b and D.1.c of this document.

5. Shared Savings/(Loss) Pool Calculations

The Shared Savings/(Loss) Pool shall be calculated as the difference between Actual Expenditures (Section D.4) and TCOC Expenditure Target (Section D.3), after the following adjustments:

a. Small Sample Size Adjustment for Random Variation

TCOC methodologies shall account for statistical uncertainty in performance measurement due to the effect of random variation in utilization and spending in small populations. MCOs shall address the impact of random variation on cost savings results through the application of a shared savings adjustment factor, defined by performance year AE attributed population size (calculated as attributed member months divided by 12).

The shared savings adjustment factor adjusts the AE's shared savings/(loss) pool

proportionately by the probability of true savings (1 minus the probability of achieving shared savings as a result of chance). The proportion of savings for which an AE is eligible shall be adjusted along a sliding scale by AE size, based on the parameters below. AEs with fewer than 5,000 attributed members with an MCO shall be classified as Small AEs.

Shared Savings/Loss Adjustment Factor Parameters

Shared Savings/Loss Adjustment Factor Parameters by AE Size and Savings Rate				Probability of Achieving Shared Savings/Loss as a Result of Chance*			
Savings %	Small AE (5-9,999)	Medium AE (10-19,999)	Large AE (20,000+)	Savings %	5,000 members	10,000 members	20,000 members
1%	73%	79%	89%	1%	27%	21%	11%
2%	82%	92%	97%	2%	18%	8%	3%
3%	91%	97%	99%	3%	9%	3%	1%
4%	95%	99%	100%	4%	5%	1%	0%
5%	98%	100%	100%	5%	2%	0%	0%
6%	99%	100%	100%	6%	1%	0%	0%

Source: Weissman J, Bailit MH, D'Andrea G, Rosenthal MB. "The Design and Application of Shared Savings Programs: Lessons from Early Adopters," *Health Affairs*, September 2012

b. Impact of Quality and Outcomes

The Shared Savings/(Loss) Pool shall be adjusted based on an assessment of performance relative to a set of quality measures for the attributed population. An Overall Quality Score will be generated for each AE, according to the methodology detailed in Attachment B: Quality Framework and Methodology for Comprehensive and Specialized LTSS Accountable Entities. The Shared Savings/(Loss) Pool must be multiplied by the Overall Quality Score.

c. Maximum Allowable Shared Savings/(Loss) Pool

In any given performance year, the Shared Savings Pool must not exceed 10% of the AE’s contract revenue. In instances where the AE is responsible for downside risk, the Shared Loss Pool must not exceed 5% of the AE’s contract revenue.

6. AE Share of Savings/(Loss) Pool

In Year 1, AEs may be eligible to retain up to 40% of the Shared Savings Pool, as defined in Section D.5 above. AEs assuming downside risk may be eligible for up to 60% of the Shared Savings Pool, and may be responsible for up to 60% of the Shared Loss Pool.

AE Shared Savings Model	AE Share of Savings	Maximum Allowable Shared Savings Pool	Maximum Allowable Shared Loss Pool	AE Share of Losses
Option 1: Shared savings only	Up to 40% of Savings Pool	10% of AE contract revenue	NA	NA
Option 2: Shared savings + risk	Up to 60% of Savings Pool	10% of AE contract revenue	5% of AE contract revenue	Up to 60% of Loss Pool

7. Required Progression to Risk Based Arrangements

Qualified TCOC-based contractual arrangements (or “Certified AEs”) must demonstrate a progression of risk to include meaningful downside shared risk within three years of AE program participation. After five years, development and implementation funding will end, and AEs will be sustained going forward based on their successful performance and associated financial rewards in accordance with their MCO contract(s).

EOHHS has defined “meaningful risk” based on learnings from other states, OHIC requirements and federal MACRA rules. Marginal risk and loss caps are defined with a range, EOHHS anticipates that smaller organizations will fall on the lower end of that range. The required progression of increasing risk for all comprehensive AEs is as follows:

	Marginal Risk <i>AE Share of Losses</i>	Loss Cap <i>Maximum Shared Loss Pool</i>
<i>Definition</i>	<i>The percentage of any Shared Loss Pool for which the AE is financially at risk.</i>	<i>The maximum percentage of the AE’s contract revenue for which the AE is financially at risk.</i>
Year 1	0	NA
Year 2	0	NA
Year 3	15 - 30% of any Shared Loss Pool	At least 2% No more than 10%
Year 4	30 - 50% of any Shared Loss Pool	At least 2% No more than 10%
Year 5	50 - 60% of any Shared Loss Pool	At least 2% No more than 10%

It is EOHHS’s intent to align risk requirements with the standards established by the Office of the Health Insurance Commissioner (OHIC) to the extent possible. Alternatives for larger organizations or entities that include a hospital may be considered in the future.

In the event of a shared risk arrangement with an AE, it is necessary to ensure that the AE has the capacity to pay for its share of any losses. To accomplish this the MCO shall utilize a withhold to ensure that funds are available for financial settlement with the AE in the event that medical expenses exceed the total cost of care projection for the performance period. At a minimum, the withhold must capture 75 percent of the maximum shared loss pool. MCO’s final settlement with the AE with regard to a withhold is based on actual experience in relation to the TCOC calculation.

Should an MCO and AE wish to share risk on a more accelerated schedule than that outlined above, the MCO and AE shall submit written documentation to EOHHS, including:

- the draft contractual financial terms between the parties;
- a statement of why the AE is qualified to assume greater risk than that outlined above,

including its infrastructure to manage clinical risk, an established record of meeting quality metrics, and the likelihood that the AE will meet the quality thresholds established by EOHHS and the MCO; and

- documentation of secured funds necessary to meet the maximum financial obligation that the AE could potentially incur under the terms of the proposed agreement.

EOHHS together with state partners (e.g. DBR and OHIC), will review the aforementioned information, and decide as to whether the arrangement may proceed.

Additionally, if an AE enters into an arrangement that provides for shared losses with a total potential risk that equals or exceeds 10% of expected expenditures, the AE must meet all the financial reserve and risk-based capital requirements required of an MCO, with oversight by the Department of Business Regulation.⁴ EOHHS anticipates that any AEs taking on such risk must, at a minimum, demonstrate adequate capitalization to cover three months of claims.⁵

TCOC Methodology: Required Elements for Specialized LTSS AEs

TCOC arrangements with specialized LTSS AEs must meet the following requirements, listed here and described in more detail below:

1. Defining a Historical Base
2. Required Adjustments to the Historical Base
3. TCOC Expenditure Target for the Performance Period
4. Actual Expenditures for the Performance Period
5. Shared Savings/(Loss) Pool Calculations
6. AE Share of Shared Savings/(Loss) Pool
7. Required Progression to Risk Based Arrangements

Note that the specialized LTSS AE Program is a pilot program and as such, EOHHS intends to engage in a systematic review of the guidelines established below as the program develops.

1. Defining a Historical Base

a. AE Specific Historical Cost Data

The TCOC historical base shall include three years of AE-specific historical cost data with equal weighting applied to each year. MCOs are strongly encouraged to use

⁴ As specified in the standards for minimum risk-based capital (RBC) requirements for health organizations in Chapter 27-4.7 of the RI general statute. <http://webserver.rilin.state.ri.us/Statutes/Title27/27-4.7//INDEX.HTM>

⁵ Note that CMS has issued guidance for shared savings programs for both Medicaid and for Medicare Shared Savings Programs. For ease of reference links to relevant State Medicaid Director Letters are provided: www.medicaid.gov/Federal-Policy-Guidance/Downloads/SMD-13-005.pdf; www.medicaid.gov/Federal-Policy-Guidance/Downloads/SMD-12-002.pdf. Links for the Medicare Shared Savings Program final rule and a CMS Factsheet are also provided:

www.cms.gov/Medicare/Medicare-Fee-for-Service-Payment/sharedsavingsprogram/Downloads/ACO_Methodology_Factsheet_ICN907405.pdf. The Shared Savings Program final rule can be downloaded at www.gpo.gov/fdsys/pkg/FR-2011-11-02/pdf/2011-27461.pdf on the Government Printing Office (GPO) website

three years of historic data in creating the benchmark in order to stabilize the historic base; at a minimum, all existing AE experience must be utilized. For newly established AEs, the TCOC historical base can be created on a simulated attributed population identified using historical utilization data, as historical authorization data for the AE may not be available.

b. Covered Services

TCOC methodologies shall include all Medicaid costs associated with covered services listed in Attachment A that are included in EOHHS' contract with MCOs, with the clarifications/exceptions listed below. In addition, EOHHS intends to include equivalent Medicaid fee-for-service covered services for people not enrolled in managed care, for the performance year. Any further adjustments to covered services outside of those listed below must be requested in writing and pre-approved by EOHHS prior to MCO-AE contract execution for the affected contractual performance year:

- I. Exclude services currently covered under stop-loss provisions between EOHHS and the MCO;
- II. Exclude services managed by BHDDH for people with intellectual and development disabilities;
- III. Exclude long-stay/custodial nursing facility costs in excess of six consecutive months (disregarding any short-term acute hospital or skilled nursing facility stays that interrupt an otherwise continuous long-stay/custodial nursing facility stay);
- IV. Exclude HSTP performance incentive payments and CTC payments.
- V. Include and define any other infrastructure payments made by MCOs or EOHHS to AEs and AE-affiliated providers.

c. Mitigation of Impact of Outliers: Claims threshold for high cost claims

TCOC data shall be adjusted to exclude costs in excess of \$100,000 per member per year. However, TCOC expenditures must include 10% of any annualized spending per member above the truncation threshold.

d. Adjusting for a Changing Risk Profile

To account for possible changes in the risk profile of an AE's attributed patient population over the historical base years, a risk adjustment methodology, using a clinical risk adjustment software, shall be applied. Under such an approach, risk calculations and any adjustments shall be applied at the total attributed population and not the EOHHS rate cell level. The TCOC methodology must describe the risk-adjustment method including underlying software parameters set by the MCO/payer. With EOHHS approval, adjustments using clinical and social risk factor data exogenous to the risk adjustment methodologies described above may be used. The MCO/payer may also propose an alternative approach to risk adjustment. The risk adjustment method must be equivalently provided to the MCO-enrolled and Medicaid fee-for-service populations within the AE. Information on risk adjustment methodologies shall be disclosed to contracting AEs.

e. Historical Base with Required Cost Trend Assumptions

When projecting (or trending) historical costs forward into the performance year, TCOC methodologies shall appropriately account for trends in nursing facility and home and community-based LTSS spending. Unless otherwise approved by EOHHS, trends assigned to TCOC baselines shall not exceed the final cumulative trends to the medical portion of Rhody Health Options rates for the nursing facility and the community LTSS capitation cells for Medicaid-only and Medicare-Medicaid populations contained in the EOHHS data books. The trends shall be applied to the AE in aggregate based on the AE's member mix.

2. Required Adjustments to the Historical Base

In order to prospectively establish an AE's TCOC Expenditure Target, the following adjustments to the historical base must be applied. No additional adjustments are allowed without prior approval from EOHHS. EOHHS anticipates that historic costs for members enrolled in the Medicare-Medicaid plan may require adjustment.

a. Adjustment for Prior Year Savings

The TCOC Expenditure Target must include an upward adjustment equal to an AE's share of prior year savings, after adjustment for quality performance, so that AEs have an opportunity to retain a portion of generated savings year over year. This adjustment must not exceed 2% of the unadjusted TCOC Expenditure Target.

b. Adjustment for Historically Low-Cost AEs

Should any AE have three years of historical cost data demonstrating that risk-adjusted per capita spending for the AE's historically attributed patient population for TCOC covered services (see Attachment B) was significantly below the MCO average (statistically significant at $p \leq .05$), the MCO may adjust that AE's TCOC Expenditure Target upward by up to the percentage by which the TCOC fell below MCO average spending for the assessed historical time period. This adjustment must not exceed 2% of the unadjusted TCOC Expenditure Target. This adjustment shall not be applied to entities with a historically attributed patient population for TCOC covered services that was significantly above the MCO average.

3. TCOC Expenditure Target for the Performance Period

Once an AE-specific, adjusted historical base is established, this base must be trended forward into the performance period to create an AE-specific TCOC Expenditure Target. TCOC methodologies shall be based on a performance time period of 12 months aligned with the state fiscal year. Initial contractual performance time periods may extend longer than 12 months if necessary.

a. Required Cost Trend Assumptions

The adjusted historical base must be cost trended to the performance year according to the LTSS cost trend assumptions described in Section E.1.e of this document.

b. Final Target Adjusted for Changes in the Attributed Population's Risk Profile

A risk adjustment methodology must be applied to assess any changes in an attributed population's risk profile from the risk-adjusted historical base to the contractual performance period, provided it can be equally applied to the MCO-enrolled and

Medicaid fee-for-service populations within the AE. This methodology must be consistent with the LTSS risk adjustment methodology used in developing the adjusted historical base as described in Section E.1.d of this document.

4. Actual Expenditures for the Performance Period

a. Calculate Actual Expenditures Consistent with the Historical Base Methodology

Actual Expenditures for the Performance Period must be calculated consistent with the LTSS historical base methodology as described in Sections E.1.b and E.1.c of this document.

5. Shared Savings/(Loss) Pool Calculations

The Shared Savings/(Loss) Pool shall be calculated as the difference between Actual Expenditures (Section E.4) and the TCOC Expenditure Target (Section E.3), after the following adjustments:

a. Small Sample Size Adjustment for Random Variation: Minimum Savings (Loss) Rate

Shared savings calculations are intended to provide an incentive for outcomes based on performance. There is a methodological challenge posed in differentiating results based on performance versus random variation. In the calculations for comprehensive AE TCOC projections, an accommodation is made to adjust for the impact of random variation in small populations. Given the smaller sizes in the attributed populations of the specialized LTSS AEs, there is a higher likelihood of volatility in shared savings pool calculations. EOHHS is continuing to review potential approaches to stabilizing the shared savings pool calculations. The method outlined here is preliminary pending further examination and input.

Given the smaller attributed populations expected to be attributed to specialized LTSS AEs, it is necessary to account for statistical uncertainty in performance measurement due to the effect of random variation in utilization and spending. Specialized LTSS AEs will be subject to a 4% Minimum Savings (Loss) Rate. A specialized LTSS AE must achieve shared savings of greater than or equal to 4% of the TCOC Expenditure Target in order to be eligible for shared savings. Where the AE is responsible for downside risk, the AE will share in losses if the shared loss rate is greater than or equal to 4% of TCOC Expenditure Target. During the pilot, EOHHS will assess the effectiveness of the Minimum Savings (Loss) Rate for the specialized LTSS AE program and may make changes to the adjustment or develop an alternative approach to better account for random variation. These approaches may include, but are not limited to, exclusion of low frequency high-cost services and separate calculations for higher cost conditions.

b. Impact of Quality and Outcomes

The Shared Savings/(Loss) Pool shall be adjusted based on an assessment of performance relative to a set of quality measures for the attributed population. An Overall Quality Score will be generated for each AE, according to the methodology detailed in Attachment B: Quality Framework and Methodology for Comprehensive and Specialized LTSS Accountable Entities. The Shared Savings/(Loss) Pool must be

multiplied by the Overall Quality Score.

c. Adjustment for MCO Enrollment⁶

The Shared Savings/(Loss) Pool will be adjusted based on the percentage of member months that the AE’s attributed population is enrolled in managed care. With EOHHS approval, an MCO may apply a risk adjustment methodology to account for differences in the risk of the MCO-enrolled and Medicaid fee-for-service populations.

d. Maximum Allowable Shared Savings/(Loss) Pool

In any given performance year, the Shared Savings Pool must not exceed 10% of the AE’s contract revenue. In instances where the AE is responsible for downside risk, the Shared Loss Pool must not exceed 5% of the AE’s contract revenue.

6. AE Share of Savings (Loss) Pool

In Year 1, AEs may be eligible to retain up to 40% of the Shared Savings Pool, as defined in Section E.5 above. AEs assuming downside risk may be eligible for up to 60% of the Shared Savings Pool, and may be responsible for up to 60% of the Shared Loss Pool. However, no specialized LTSS AEs will be eligible to assume downside risk in the first year of the AE program. EOHHS will issue additional requirements in the future on downside risk arrangements for specialized LTSS AEs.

Specialized LTSS AE Shared Savings Model	AE Share of Savings	Maximum Allowable Shared Savings Pool	Maximum Allowable Shared Loss Pool	AE Share of Losses
Shared savings only	Up to 40% of Savings Pool	10% of AE contract revenue	NA	NA

7. Required Progression to Risk Based Arrangements

It is anticipated that, over time, shared savings and incentive opportunities will be in relation to shared risk. AEs will be expected to move into downside risk arrangements within four to five years of the launch of the specialized LTSS AE program. After five years, development and implementation funding will end, and AEs will be sustained going forward based on their successful performance and associated financial rewards in accordance with their MCO contract(s).

EOHHS has defined “meaningful risk” based on learnings from other states, Office of the

⁶ The TCOC methodology may include MCO-enrolled and Medicaid fee-for-service populations to increase the reliability and validity of the TCOC calculations for the specialized LTSS AEs. However, EOHHS does not have federal authority to distribute shared savings payments to AEs for Medicaid beneficiaries who are not enrolled in managed care. As a result, the TCOC methodology adjusts for the proportion of a specialized LTSS AE’s attributed population that is enrolled in managed care. In contrast, specialized LTSS AEs will be eligible to earn Incentive Payments based on the AE’s performance relative to the AE’s TCOC Expenditure Target for its total attributed population, which includes MCO-enrolled and Medicaid fee-for-service beneficiaries. As articulated in the Incentive Program Requirements, 20% of the specialized LTSS AE Specific Incentive Pool shall be set aside to support potential shared savings achieved by an AE relative to the AE’s TCOC Expenditure Target, without adjustment for MCO Enrollment.

Health Insurance Commissioner (OHIC) requirements, and federal MACRA rules. Marginal risk and loss caps are defined with a range, EOHHS anticipates that smaller organizations will fall on the lower end of that range. The required progression of increasing risk for all specialized LTSS AEs is as follows:

	Marginal Risk <i>AE Share of Losses</i>	Loss Cap <i>Maximum Shared Loss Pool</i>
<i>Definition</i>	<i>The percentage of any Shared Loss Pool for which the AE is financially at risk.</i>	<i>The maximum percentage of the AE's contract revenue for which the AE is financially at risk.</i>
Year 1	0	NA
Year 2	0	NA
Year 3	0	NA
Year 4	15-30% of any Shared Loss Pool	At least 2% No more than 10%
Year 5	30-50% of any Shared Loss Pool	At least 2% No more than 10%

It is EOHHS's intent to align risk requirements with the standards established by the Office of the Health Insurance Commissioner (OHIC) to the extent possible. Alternatives for larger organizations or entities that include a hospital may be considered in the future.

In the event of a shared risk arrangement with an AE, it is necessary to ensure that the AE has the capacity to pay for its share of any losses. To accomplish this the MCO shall utilize a withhold to ensure that funds are available for financial settlement with the AE in the event that medical expenses exceed the total cost of care projection for the performance period. At a minimum, the withhold must capture 75 percent of the maximum shared loss pool. MCO's final settlement with the AE with regard to a withhold is based on actual experience in relation to the TCOC calculation.

Should an MCO and AE wish to share risk on a more accelerated schedule than that outlined above, the MCO and AE shall submit written documentation to EOHHS, including:

- the draft contractual financial terms between the parties;
- a statement of why the AE is qualified to assume greater risk than that outlined above, including its infrastructure to manage clinical risk, an established record of meeting quality metrics, and the likelihood that the AE will meet the quality thresholds established by EOHHS and the MCO;
- documentation of secured funds necessary to meet the maximum financial obligation that the AE could potentially incur under the terms of the proposed agreement.

EOHHS together with state partners (e.g. DBR and OHIC), will review the aforementioned information, and decide as to whether the arrangement may proceed.

Additionally, if an AE enters into an arrangement that provides for shared losses with a

total potential risk that equals or exceeds 10% of expected expenditures, the AE must meet all of the financial reserve and risk-based capital requirements required of an MCO, with oversight by the Department of Business Regulation.⁷ EOHHS anticipates that any AEs taking on such risk must, at a minimum, demonstrate adequate capitalization to cover three months of claims.⁸

TCOC Development Approval and Reporting Process

1. TCOC Development Approval

Medicaid MCOs and AEs must establish TCOC calculation methodologies in accordance with these requirements to serve as the basis for their shared savings and/or risk arrangements. These methodologies must be approved by EOHHS. EOHHS will review the MCO's TCOC methodologies and reserves the right to ask for modifications before granting approval.⁹ EOHHS also reserves the right to review these methodologies on an annual basis. EOHHS' approval, denial, or requests for amendment will be transmitted in writing, without unreasonable delay. Further, for specialized LTSS AEs, the TCOC calculation methodologies must be equivalently applied to the MCO-enrolled and Medicaid fee-for-service populations if both are included in the AE.

MCOs must submit details of their TCOC methodologies to EOHHS for approval in writing, in advance of contracting with AEs. Applications must document and demonstrate specific compliance with the requirements outlined in Sections C, D, and E of these requirements. Simple numerical examples may be helpful. Applications must also include comprehensive answers to the questions below:

1. Benchmark Time Period

What is the time period for the historical data used to establish an AE's cost benchmark?
How does the methodology account for attributed patients for whom no historical data is available?

2. Benchmark Data Source

What data sources are used to establish an AE's cost benchmark?

⁷ As specified in the standards for minimum risk-based capital (RBC) requirements for health organizations in Chapter 27-4.7 of the RI general statute. <http://webserver.rilin.state.ri.us/Statutes/Title27/27-4.7/INDEX.HTM>

⁸ Note that CMS has issued guidance for shared savings programs for both Medicaid and for Medicare Shared Savings Programs. For ease of reference links to relevant State Medicaid Director Letters are provided: www.medicaid.gov/Federal-Policy-Guidance/Downloads/SMD-13-005.pdf; www.medicaid.gov/Federal-Policy-Guidance/Downloads/SMD-12-002.pdf. Links for the Medicare Shared Savings Program final rule and a CMS Factsheet are also provided: www.cms.gov/Medicare/Medicare-Fee-for-Service-Payment/sharedsavingsprogram/Downloads/ACO_Methodology_Factsheet_ICN907405.pdf. The Shared Savings Program final rule can be downloaded at www.gpo.gov/fdsys/pkg/FR-2011-11-02/pdf/2011-27461.pdf on the Government Printing Office (GPO) website

⁹ In addition to this EOHHS requirement, note that depending on circumstances transparency in such arrangements is specifically required in CFR42 §438.6 Contract requirements 438.6(g): Inspection and audit of financial records – Risk contracts must provide that the state agency and the Department may inspect and audit any financial records of the entity or its subcontractors. 438.6(h) Physician Incentive plans – MCO contracts must provide for compliance with the requirements set forth in 422.208 and 422.210 of this chapter. 436.6(k) All subcontracts must fulfill the requirements of this part that are appropriate to the service or activity delegated under the subcontract.

3. Mid-Year Changes

How does the TCOC calculation account for month-to-month changes in MCO enrollment and/or PCP assignment/specialized LTSS AE attribution, whether during benchmark years or the performance year? How does the TCOC calculation account for month-to-month changes in the PCP/LTSS provider roster of an AE, whether during benchmark years or the performance year?

4. Risk Adjustment

What risk adjustment methodology will be applied to assess changes in the risk profile of an AE’s attributed patient population, over the historic base years, and between the historic base and performance period? If a clinical risk adjustment software will be utilized, provide a detailed description of the underlying software parameters.

5. Shared Savings/Loss Distribution Rate and Calculation

What portion of the eligible shared savings pool (after accounting for scaling based on quality and outcomes metrics) will be distributed to the AE?

6. Shared Savings/Loss Distribution Timing

At what time are shared savings distributions made to qualifying AEs? If distributions are made more frequently than annually, please also describe any true-up processes.

7. Alignment between MCO and FFS populations (Specialized AEs only)

Can the TCOC methodology be applied equally to MCO and Medicaid fee-for-service populations within a single specialized LTSS AE?

Where appropriate, MCOs should respond separately to the questions for comprehensive and specialized LTSS AEs. Material amendments to TCOC methodology must be approved by EOHHS in advance. If an MCO utilizes a TCOC methodology that differs in any respect from the approved methodology, EOHHS reserves the right to calculate risk- and gain-share with the MCO as if the approved methodology had been utilized, and the MCO shall provide EOHHS with all information necessary to make that calculation.

MCOs must complete and submit the *MCO/AE TCOC Reporting Template* as defined by EOHHS for each AE within 15 days, at the latest, of executing any AE contract. If any entity is certified and contracted as both a comprehensive AE and a specialized LTSS AE, separate comprehensive AE and specialized LTSS AE templates must be completed for the entity.

2. Required Ongoing Reporting

In order to monitor AE financial performance, AEs and MCOs will be required to furnish financial reports regarding risk performance on a quarterly basis to EOHHS. Quarterly reports must be submitted to EOHHS within 120 days of the close of the quarter, as detailed below.

Performance Period 1: Performance Quarters	Quarterly Report Due to EOHHS
Q1: Jan 1 st – Mar 31 st 2018	July 29 th 2018
Q2: Apr 1 st – Jun 30 th 2018	October 28 th 2018
Q3: Jul 1 st – Sep 30 th 2018	January 28 th 2018
Q4: Oct 1 st – Dec 31 st 2018	April 29 th 2018
Q5: Jan 1 st – Mar 31 st 2019	July 29 th 2019
Q6: Apr 1 st – Jun 30 th 2019	October 28 th 2019

Other APMs for Specialized LTSS AEs

Currently, most Medicaid nursing facility and home and community-based LTSS in Rhode Island are reimbursed using encounter-based and other fee-for-service payment models that do not reward quality, efficiency, or value. EOHHS seeks to move away from fee-for-service payment models toward alternative payment models (APMs) that incentivize providers to be more accountable for Medicaid patients' care and outcomes. EOHHS intends to pilot test APMs, including bundled payments, per member per month (PMPM) payments, episodic payments, and other value-based payment (VBP) models, on a voluntary basis with Partner and Affiliate Providers in specialized LTSS AEs. EOHHS anticipates requesting expenditure authority under Section 1115(a)(2) of the Social Security Act to implement APMs for nursing facility and home and community-based LTSS. Additional requirements around the APMs and the APM pilot opportunities will be provided separately.

Comprehensive AE TCOC Methodology Example

OHHS Comprehensive AE Total Cost of Care (TCOC) Guidance						AE Specific Variables		
Comprehensive AE TCOC Calculation Tool						Calculation Variables		
*Note: all data is illustrative only								
		SFY 2014	SFY 2015	SFY 2016		SFY 2018		
	AE Specific Historical Data Input: Membership and Cost	Year 1	Year 2	Year 3	Historical Base	Performance Year		
INPUT ->	Attributed Lives (Members)	5,000	5,000	5,250	5,150	5,250		
INPUT ->	PMPM	\$345.00	\$347.00	\$320.00	\$330.29	\$350.00		
1 Calculating the Historical Base and Initial TCOC Target					Historical Base		Performance Year Target	
		Year 1	Year 2	Year 3	\$	pmpm	\$	pmpm
A	Total Cost of Care (Unadjusted)	\$20,700,000	\$20,820,000	\$20,160,000	\$20,412,000	\$330.29		
B	Base Year Weight	10%	30%	60%				
C	Trend Factor		2%	2%				
D	Trend Adjustment	\$836,280	\$416,400	\$0	\$208,548	\$3.37		
E	Risk Adjustment	\$871,579	\$429,278	\$0	\$215,941	\$3.49		
F	Total Cost of Care (Adjusted)	\$22,407,859	\$21,665,678	\$20,160,000	\$20,836,489	\$337.16		
G	Prior Year Savings Adjustment			\$176,400	\$176,400	\$2.85		
H	Historical Performance Adjustment			\$408,240	\$408,240	\$6.61	Projected Trend	Time Period (Yrs)
I	Total Cost of Care (Adjusted, with Sustainability Adjustments)				\$21,421,129	\$346.62	2%	2
J	Total Cost of Care (Initial Target)						\$22,286,543	\$360.62
							TCOC Initial PY Target	
2 Calculating the Final TCOC Target								
A	Risk Adjustment						\$458,976	\$7.29
B	*Final Target based on risk-adjusted PMPM with performance year membership				Impact of change in membership		\$432,748	\$0.00
	Total Cost of Care (Final Target)						\$23,178,267	\$367.91
							TCOC Final PY Target	
3 Calculating and Distributing the Shared Savings (Loss) Pool							Performance Year	
							\$	pmpm
A	Total Cost of Care (Actual Expenditures)						\$22,050,000	\$350.00
							TCOC Actual	
B	Shared Savings (Loss) Pool						\$1,128,267	\$17.91
C	Random Variation Adjustment						-\$22,565	-\$0.36
D	Quality and Outcomes Adjustment						\$0	\$0.00
E	Shared Savings (Loss) Pool (Adjusted)						\$1,105,702	\$17.55
F	Eligible Shared Savings Pool						\$1,105,702	\$17.55
G	Eligible Shared Loss Pool						NO	NO
H	Maximum Allowable Shared Savings Pool						\$2,317,827	\$36.79
I	Maximum Allowable Shared Loss Pool						-\$1,158,913	-\$18.40
J	Final Shared Savings Pool						\$1,105,702	\$17.55
K	Final Shared Loss Pool						NO	NO
L	AE Share of Shared Savings (Loss) Pool							
M	Option 1 AEs: Shared Savings Only	AE Share	20%	30%	40%			
			\$	pmpm	\$	pmpm	\$	pmpm
	Shared Savings		\$221,140	\$3.51	\$331,711	\$5.27	\$442,281	\$7.02
N	Option 2 AEs: Shared Savings and Risk	AE Share	40%	50%	60%			
			\$	pmpm	\$	pmpm	\$	pmpm
	Shared Savings		\$442,281	\$7.02	\$552,851	\$8.78	\$663,421	\$10.53
	Shared Loss		NO	NO	NO	NO	NO	NO

Cap: 10% AE Contract
Cap: 5% AE Contract

Adjustment Details

1 Historical Base and Initial TCOC Target Adjustments

		Year 1	Year 2	Year 3	Historical Base		
Risk Adj	E	Average Risk Score	0.95	0.97	0.99	0.98	<- INPUT
		TCOC (Dollars): Years 1 and 2 Risk-Adjusted to Year 3 Risk Mix	\$359.53	\$354.15	\$320.00	\$334.20	
		Risk Adjustment	\$14.53	\$7.15	\$0.00	\$3.60	
Adjustment for Prior Year Savings	G	Prior Year Savings: Target - Actual TCOC (pmpm)			\$7.00		<- INPUT
		Eligible Adjustment: AE Share			\$2.80	40%	AE Share
		Eligible Adjustment: Total Dollars			\$176,400		
		Maximum Adjustment for Prior Year Savings (2%)			\$408,240		2% Max Allowable
		Eligible Adjustment or Max Allowable			\$176,400		
Historical Performance Adjustment	H	MCO Average Cost (pmpm)			\$334.00		<- INPUT
		MCO Average Risk Score			1.00		
		AE Average Risk Score			0.99		
		AE Cost (pmpm)			\$320.00		
		AE Cost with FQHC PPS Adjustment (pmpm)			\$320.00	\$0.00	FQHC PPS Adjustment (pmpm), if applicable
		AE Average Risk Normalized Cost (pmpm)			\$323.23		
		Cost Score (% above/below MCO Average)			-4%		
		Eligible Adjustment			\$13.84		
		Eligible Adjustment: Total Dollars			\$855,593		
		Max Allowable Adjustment			\$408,240		2% Max Allowable
		Eligible Adjustment or Max Allowable			\$408,240		

2 Final TCOC Target Adjustments

		PY		
Risk Adj	A	Average Risk Score	1.01	<- INPUT
		Risk Adjustment	\$7.29	

3 Shared Savings (Loss) Pool Adjustments

Small Sample Size Random Variation Adjustment	C Shared Savings (Loss) Adjustment Factor Parameters by AE Size and Savings Rat				
	Savings %	Small AE	Medium AE	Large AE	
		(5-9,999)	(10-19,999)	(20,000+)	
	1%	73%	79%	89%	
	2%	82%	92%	97%	
	3%	91%	97%	99%	
	4%	95%	99%	100%	
	5%	98%	100%	100%	
	6%	99%	100%	100%	
	Parameter Lookup				
	Savings %	4.87%	5.00%	5.00%	Savings Rate Bracket Lookup
	Small AE	98%			
	Medium AE	100%			
Large AE	100%				
Random Variation Adjustment	98%		Small AE	AE Size Classification	

Quality Adj	D	Quality Score Multiplier	1.00	<- INPUT
		Detailed Quality Measure Scoring Methodology to come		

- 1 TCOC inputs must account for covered service exclusions and claims cap truncation
- 2 Base Year Weights are flexible, example uses MSSP methodology
- 3 Placeholder trend, to populate OHHS data book trends, Year 2 trend = Year 2/Year 1
- 4 Change compounding formula based on time period between Base Year 3 and Performance Year (assumes 2 year period)

Specialized LTSS AE TCOC Methodology Example

OHHS Specialized AE Total Cost of Care (TCOC) Guidance		AE Specific Variables
Specialized AE TCOC Calculation Tool		Calculation Variables

***Note: All data is illustrative only**

		SFY 2014	SFY 2015	SFY 2016	SFY 2018	
INPUT ->	AE Specific Historical Data Input: Membership and Cost	Year 1	Year 2	Year 3	Historical Base	Performance Year
	Attributed Lives (Members)	1,000	1,000	1,000	1,000	1,000
INPUT ->	PMPM	\$1,225.00	\$1,250.00	\$1,275.00	\$1,262.50	\$1,225.00

1 Calculating the Historical Base and Initial TCOC Target				Historical Base		Performance Year Target	
				\$	pmpm	\$	pmpm
A	Total Cost of Care (Unadjusted)	Year 1	Year 2	Year 3	\$15,150,000	\$1,262.50	
B	Base Year Weight	10%	30%	60%			
C	Trend Factor		2%	2%			
D	Trend Adjustment	\$593,880	\$300,000	\$0	\$149,388	\$12.45	
E	Risk Adjustment	\$0	\$0	\$0	\$0	\$0.00	
F	Total Cost of Care (Adjusted)	\$15,293,880	\$15,300,000	\$15,300,000	\$15,299,388	\$1,274.95	
G	Prior Year Savings Adjustment			\$303,000	\$303,000	\$25.25	
H	Historical Performance Adjustment			\$303,000	\$303,000	\$25.25	
I	Total Cost of Care (Adjusted, with Sustainability Adjustments)				\$15,905,388	\$1,325.45	Projected Trend 2% me Period (Yrs) 2
J	Total Cost of Care (Initial Target)						\$16,547,966 \$1,379.00
							TCOC Initial PY Target

2 Calculating the Final TCOC Target					
A	Risk Adjustment			\$0	\$0.00
B	*Final Target based on risk-adjusted PMPM with performance year membership		Impact of change in membership	\$0	\$0.00
	Total Cost of Care (Final Target)			\$16,547,966	\$1,379.00
TCOC Final PY Target					

3 Calculating and Distributing the Shared Savings (Loss) Pool				Performance Year	
				\$	pmpm
A	Total Cost of Care (Actual Expenditures)			\$14,700,000	\$1,225.00
TCOC Actual					
B	Shared Savings (Loss) Pool			\$1,847,966	\$154.00
C	Shared Savings Pool			\$1,847,966	\$154.00
D	Shared Loss Pool			NO	NO
E	Shared Savings Pool After MSR			\$1,847,966	\$154.00
F	Shared Loss Pool After MLR			NO	NO
G	Quality and Outcomes Adjustment: Quality Score Multiplier			1.00	
H	Shared Savings Pool (Adjusted)			\$1,847,966	\$154.00
I	Shared Loss Pool (Adjusted)			NO	NO
J	Adjustment for MCO Enrollment (% MCO Member Months)			50%	
K	Eligible MCO-Adjusted Shared Savings Pool			\$923,983	\$77.00
L	Eligible MCO-Adjusted Shared Loss Pool			NO	NO
M	Maximum Allowable MCO Shared Savings Pool			\$827,398	\$68.95
N	Maximum Allowable MCO Shared Loss Pool			-\$413,699	-\$34.47
O	Final MCO Shared Savings Pool			\$827,398	\$68.95
P	Final MCO Shared Loss Pool			NO	NO

AE Share of Final Shared Savings (Loss) Pool							
Option 1 AEs: Shared Savings Only							
AE Share		20%		30%		40%	
		\$	pmpm	\$	pmpm	\$	pmpm
Shared Savings		\$165,480	\$13.79	\$248,219	\$20.68	\$330,959	\$27.58

Cap: 10% AE Contract
Cap: 5% AE Contract

Adjustment Details

1 Historical Base and Initial TCOC Target Adjustments

		Year 1	Year 2	Year 3	Historical Base		
Risk Adj	E	Average Risk Score	1.0	1.0	1.0	1.00	<- INPUT
		TCOC (Dollars): Years 1 and 2 Risk-Adjusted to Year 3 Risk Mix	\$1,225.00	\$1,250.00	\$1,275.00	\$1,262.50	
		Risk Adjustment	\$0.00	\$0.00	\$0.00	\$0.00	
Adjustment for Prior Year Savings	G	Prior Year Savings: Target - Actual TCOC (ppm)			\$65.00		<- INPUT
		Eligible Adjustment: AE Share			\$26.00	40%	AE Share
		Eligible Adjustment: Total Dollars			\$312,000		
		Maximum Adjustment for Prior Year Savings (2%)			\$303,000		2% Max Allowable
		Eligible Adjustment or Max Allowable			\$303,000		
Historical Performance Adjustment	H	MCO Average Cost (ppm)			\$1,350.00		<- INPUT
		MCO Average Risk Score			1.0		
		AE Average Risk Score			1.0		
		AE Cost (ppm)			\$1,275.00		
		AE Average Risk Normalized Cost (ppm)			\$1,275.00		
		Cost Score (% above/below MCO Average)			-6%		
		Eligible Adjustment			\$70.14		
		Eligible Adjustment: Total Dollars			\$841,667		
		Max Allowable Adjustment			\$303,000		2% Max Allowable
		Eligible Adjustment or Max Allowable			\$303,000		

2 Final TCOC Target Adjustments

		PY		
Risk Adj	A	Average Risk Score	1.00	<- INPUT
		Risk Adjustment	\$0.00	

3 Shared Savings (Loss) Pool Adjustments

			Targeted Expenditures	
MSR/ MLR	E/F	Application of Minimum Shared Savings (Loss) Rate		
		Minimum Savings (Loss) Rate	4.0%	
		Minimum Savings	\$661,919	\$55.16
		Minimum Loss	-\$661,919	-\$55.16

- 1 TCOC inputs must account for covered service exclusions and claims cap truncation
- 2 Base Year Weights are flexible, example uses MSSP methodology
- 3 Placeholder trend, to populate OHHS data book trends, Year 2 trend = Year 2/Year 1
- 4 Change compounding formula based on time period between Base Year 3 and Performance Year (assumes 2 year period)

Attachment B: Quality Framework and Methodology for Comprehensive and Specialized LTSS Accountable Entities

A. Principles and Quality Framework

A fundamental element of the EOHHS Accountable Entity (AE) program, and specifically the transition to alternative payment models, is a focus on quality and outcomes. Measuring and rewarding quality as part of a value based model is critical to ensuring that quality is maintained and/or improved while cost efficiency is increased. As such, the payment model must be designed to both recognize and reward historically high-quality AEs while also creating meaningful opportunities and rewards for quality improvement. This model must be measurable, transparent and consistent, such that participants and stakeholders can view and recognize meaningful improvements in quality as this program unfolds.

As a starting point, the Year 1 requirements described below are intended to provide an interim structure that permits baseline measurement and assessment, while allowing for future refinements that continuously “raise the bar” toward critical improvements in quality and outcomes.

B. Shared Savings Opportunity

Medicaid AEs are eligible to share in earned savings based on a quality multiplier to be determined as follows:

- The AE must meet the established total cost of care (TCOC) threshold as determined using the EOHHS approved TCOC methodology to be eligible for shared savings.
- The quality measures included as part of the Medicaid Accountable Entity Common Measure Slate (including up to 4 additional optional menu measures for comprehensive AEs) will be used to determine a quality score for each AE.
- For comprehensive AEs, all admin (claims-based) measures must be generated and reported by the MCO. AEs must provide the necessary data to the MCO to generate any hybrid or EHR-only measures. Any EHR-only measures generated by an AE may be reported for the AE’s full attributed population.
- For specialized LTSS AEs, measures must be generated for an AE’s entire Medicaid attributed population, including MCO-enrolled and not enrolled beneficiaries.
- The quality score will be used as a multiplier to determine the percentage of the shared savings pool the AE is eligible to receive. Quality scores will be calculated distinctly for each MCO with which the AE is contracted.
- Performance year periods, which are aligned with the state fiscal year calendar, will be tied to the calendar year quality performance period ending within the performance year period. The prior calendar year quality performance period will serve as the benchmark period, as shown below.

Performance Year	Performance Time Period	Quality Measurement Performance Period	Quality Measurement Benchmark Period	Payment
------------------	-------------------------	--	--------------------------------------	---------

PY 1	SFY 2019*	HEDIS 2019, CY 18	HEDIS 2018, CY 17	SFY 2020
PY 2	SFY 2020	HEDIS 2020, CY 19	HEDIS 2019, CY 18	SFY 2021
PY 3	SFY 2021	HEDIS 2021, CY 20	HEDIS 2020, CY 19	SFY 2022
PY 4	SFY 2022	HEDIS 2022, CY 21	HEDIS 2021, CY 20	SFY 2023

*Performance Year 1 may be an extended performance period to allow for differential start dates; as such it must begin no earlier than January 1, 2018 and no later than July 1, 2018 and must end on June 30, 2019.

C. Medicaid AE Common Measure Slate for Comprehensive AEs

For comprehensive AEs, EOHHS requires the use of the measures included in the Medicaid Comprehensive AE Common Measure Slate (see below). In addition to the 11 required core measures, each MCO and AE may include up to 4 additional optional measures identified by the MCO and AE from the RI State Innovation Model (SIM) menu measure set and/or Medicaid Child and/or Adult Core Set.

Note that EOHHS may define an additional member retention measure for piloting in Year 1, and full implementation beginning in Year 2.

The Common Measure Slate for comprehensive AEs has been developed with the following considerations:

- Alignment with the RI SIM core measure set.
- Cross cutting measures across multiple domains with a focus on clinical/chronic care, behavioral health, and social determinants of health.
- Feasibility of data collection and measurement and minimization of administrative burden.
- A minimum number of measures necessary to enable a concentrated effort and meaningful assessment of quality.
- Focus on statewide strategic priorities outlined by EOHHS, RI Department of Health, RI Department of Behavioral Healthcare, Developmental Disabilities and Hospitals, and the Office of the Health Insurance Commissioner.

D. Comprehensive AE Quality Score Determination

Part 1: Relative Weight of Individual Measures for Comprehensive AEs

The Quality Score is to be developed based on assigning a weight to each individual measure. Measure weighting is subject to negotiation between the MCO and AE, but must meet the following requirements:

- Measures for which the AE’s baseline meets or exceeds the current Medium benchmark cannot exceed 10% weight,
- Measures with no baseline cannot exceed 10% weight, and
- The Social Determinants of Health (SDOH) Screen measure must be assigned a 10% weight.

Mandatory measures for which baseline data can be calculated will be pay for performance in Year 1. A Measure Score will be generated for each measure according to the criteria specified below in Section E Part 2.

The following four mandatory measures, for which baseline data is not available, will be pay for reporting in Year 1:

- Measure 5. Tobacco Use: Screening and Cessation Intervention
- Measure 9. Screening for Clinical Depression & Follow-up Plan
- Measure 10. Social Determinants of Health (SDOH) Screen
- Measure 11. Self-assessment/rating of health status

A pass/fail score (either 100% or 0%) will be awarded for these measures, based on timely submission of required data in accordance with agreed upon formats. There will be no partial credit for reporting. Year 1 data will be used to establish a baseline for these measures.

Optional admin (claims-based) measures must be pay for performance in Year 1. Optional hybrid or EHR-only measures may be pay for performance or pay for reporting in Year 1.

The overall Quality Score must be a sum of the Measure Specific Quality Score times the Measure Weight for each measure.

Example:

List of Measures	Measure Specific Quality Score	Measure Weight	Measure Specific Quality Score * Measure Weight
Measure 1	100%	20%	20%
Measure 2	100%	20%	20%
Measure 3	75%	20%	15%
Measure 4	50%	30%	15%
Measure 5	0%	10%	0%
Overall Quality Score			70%

Part 2) Comprehensive AE Measure Specific Performance

Measure specific performance is intended to both reward historically high-quality providers and create opportunities for low performers to benefit from improvement.

For each measure included in the Measure Slate, two measure specific benchmark targets are established based on NCQA Medicaid Quality Compass data.

- High benchmark target: NCQA Medicaid Quality Compass percentile measure score defined by measure based on current MCO performance (see Common Measure Slate for measure specific benchmarks)
- Medium benchmark target: NCQA Medicaid Quality Compass 66th percentile measure score for all measures

For those measures for which NCQA Medicaid Quality Compass data is not available, a Medicaid statewide median benchmark will be generated, and a High and Medium benchmark target will be established.

Each measure must be assessed and scored based on performance relative to the benchmark targets or achievement of meaningful improvement, as defined below.

Comprehensive AE Measure Specific Scoring

Measure Performance Category	Measure Score	Performance Category Criteria
High Performance	100%	AE score meets or exceeds the High benchmark target
Medium Performance	75%	AE score meets or exceeds the Medium benchmark target (but is below the High benchmark target)
Improvement	50%	AE score is below the Medium benchmark target but shows meaningful improvement over the prior year's performance. Meaningful improvement is defined as improvement half way from the AE's baseline to the Medium performance target, or 10 percentage point improvement, whichever is lower, with a minimum required improvement of at least 3 percentage points.
Fail	0%	AE score is below the Medium benchmark target and does not show meaningful improvement over the prior year's performance, as defined above.

Example: Comprehensive AE Measure 1. Breast Cancer Screening

High Benchmark = 65.06 (75th Percentile NCQA Quality Compass)

Medium Benchmark = 63.10 (66th Percentile NCQA Quality Compass)

AEs	Year 1 Score	Year 2 Score	AE Performance Category	Measure Specific Score
AE 1	66%	68%	High Performance	100%
AE 2	62%	64%	Medium Performance	75%
AE 3	55%	60%	Improvement	50%
AE 4	50%	52%	Fail	0%

Proposed Comprehensive AE Common Measure Slate*

Measure Name	NQF #	Measure Steward	Measure Domain	Measure Source	Measure Description	Age Cohort	High Benchmark	Medium Benchmark
1. Breast Cancer Screening	2372	HEDIS®	Preventive Care	Admin	The percentage of women 50-74 years of age who had a mammogram to screen for breast cancer	Adult	QC 75th percentile	QC 66 th percentile

*Measures are subject to change based on the recommendations of OHIC's Measure Alignment Review Committee

Measure Name	NQF #	Measure Steward	Measure Domain	Measure Source	Measure Description	Age Cohort	High Benchmark	Medium Benchmark
2. Weight Assessment & Counseling for Physical Activity, Nutrition for Children & Adolescents	0024	HEDIS®	Preventive Care	Hybrid	The percentage of members 3-17 years of age who had an outpatient visit with a PCP or OB/Gyn and who had evidence of the following during the measurement year: BMI percentile, Counseling for Physical Activity and Nutrition	Pediatric	QC 90 th percentile	QC 66 th percentile
3. Developmental Screening in the 1 st Three Years of Life	1448	OHSU	Preventive Care	Admin or Hybrid	The percentage of children screened for risk of developmental, behavioral and social delays using a standardized screening tool in the first three years of life; this is a measure of screening in the first three years of life that includes three, age-specific indicators assessing whether children are screened by 12 months of age, by 24 months of age and by 36 months of age	Pediatric	65% score	50% score
4. Adult BMI Assessment	N/A	HEDIS®	Preventive Care	Hybrid	The percentage of members 18-74 years of age who had an outpatient visit and whose body mass index (BMI) was documented during the measurement or the year prior to the measurement year	Adult	QC 90 th percentile	QC 66 th percentile
5. Tobacco Use: Screening and Cessation Intervention	0028	AMA-PCPI	Preventive Care	Admin or Hybrid	Percentage of patients aged 18 years and older who were screened for tobacco use one or more times within 24 months AND who received cessation counseling intervention if identified as a tobacco user	Adult	N/A Reporting only in Y1	N/A Reporting only in Y1

Measure Name	NQF #	Measure Steward	Measure Domain	Measure Source	Measure Description	Age Cohort	High Benchmark	Medium Benchmark
6. Comp. Diabetes Care: HbA1c Control (<8.0%)	0575	HEDIS®	Chronic Illness	Hybrid	The percentage of members 18-75 years of age with diabetes (type 1 and 2) w/HbA1C control <8.0%	Adult	QC 75 th percentile	QC 66 th percentile
7. Controlling High Blood Pressure	0018	HEDIS®	Chronic Illness	Hybrid	The percentage of members 18-85 years of age who had a diagnosis of hypertension and whose BP was adequately controlled during the measurement year based on the following criteria: <ul style="list-style-type: none"> • 18-59 years of age whose BP was <140/90 mm Hg • 60-85 years of age with a dx of diabetes whose BP was <140/90 mm Hg • 60-85 years of age without a dx of diabetes whose BP was <150/90 mm Hg 	Adult	QC 90 th percentile	QC 66 th percentile
8. Follow-up after Hospitalization for Mental Illness (7 Days)	0576	HEDIS®	Behavioral Health	Admin	The percentage of discharges for members 6 years of age and older who were hospitalized for treatment of selected mental illness diagnosis and who had a follow-up visit with a mental health practitioner	Adult and Pediatric	QC 90 th percentile	QC 66 th percentile
9. Screening for Clinical Depression & Follow-up Plan	0418	CMS	Behavioral Health	Practice-reported	Percentage of patients aged 12 years and older screened for clinical depression using an age appropriate standardized tool AND follow-up plan documented	Adult and Pediatric	N/A Reporting only in Y1	N/A Reporting only in Y1

Measure Name	NQF #	Measure Steward	Measure Domain	Measure Source	Measure Description	Age Cohort	High Benchmark	Medium Benchmark
10. Social Determinants of Health (SDOH) Screen	N/A	N/A	Social Determinants		% of members screened as defined per the SDOH elements in the Medicaid AE certification standards*	Adult and Pediatric	N/A	N/A
11. Self-Assessment/Rating of Health Status	N/A	N/A			Measure to be defined and submitted to EOHHS for approval (e.g., Institute for Healthcare Improvement)	Adult and Pediatric	N/A	N/A

Technical specifications for the measures above will be provided separately.

* Section 5.2.2 of the AE Certification Standards requires that each AE:

“Together with partner MCOs, develop, implement, and maintain procedures for completing an initial SDOH Care Needs Screening for Attributed Members based on a defined protocol.... The screening shall evaluate Attributed Members’ health-related social needs in order to determine the need for social service intervention. Such services shall include but not be limited to:

- *Housing stabilization and support services;*
- *Housing search and placement;*
- *Food security;*
- *Support for Attributed Members who have experience of violence.*
- *Utility assistance;*
- *Physical activity and nutrition...”*

Optional Menu Metrics for Comprehensive AEs

Select no more than 4 measures from the SIM Menu Measure Set and/or the Medicaid Child and/or Adult Core Quality Measure Set.



2017-child-core-set
(1).pdf



2017-adult-core-set
.pdf



Crosswalk of RI
Aligned Measure Set

E. Medicaid AE Common Measure Slate for Specialized LTSS AEs

For specialized LTSS AEs, EOHHS requires the use of all measures included in the Medicaid Specialized LTSS AE Common Measure Slate (see below). The Common Measure Slate for specialized LTSS AEs has been developed with the following considerations:

- Cross cutting measures across multiple domains with a focus on LTSS, healthy aging, behavioral health, and social determinants of health.
- Feasibility of data collection and measurement and minimization of administrative burden.
- A focused set of measures that will enable a concentrated effort and meaningful assessment

of quality.

- Focus on statewide strategic priorities outlined by EOHHS and the RI Division of Elderly Affairs.

F. Specialized LTSS AE Quality Score Determination

Year 1: Unlike the Comprehensive AEs, the SIM measure set does not specifically include a set of LTSS-related measures. As such, there is a strong emphasis on reporting and establishing baseline data for the measures in the first year of the specialized LTSS AE program. All measures must be reported using EOHHS measure specifications (to be released separately). For Year 1, all measures included in the Measure Slate will be assigned a weight and included in the Overall AE Quality Score for each AE. The Quality Weight will be determined in the contract between the MCO and AE. However, the minimum Quality Weight for the SDOH measure is 10%. Each measure will also be given a Reporting Score, which will be a pass/fail score (either 100% or 0%), based on timely submission of required data in accordance with agreed upon formats; there will be no partial credit for reporting. The Measure Specific Quality Score will be calculated as the product of the Quality Weight and the Reporting Score for the measure (i.e., Measure Specific Quality Score = Quality Weight x Reporting Score). The Overall AE Quality Score will be calculated as the sum of the Measure Specific Quality Scores for each measure.

Example: Overall AE Quality Score Calculation for a Specialized LTSS AE in Year 1

Measure	Quality Weight	Reporting Score	Quality Score
Measure 1	5%	100%	5%
Measure 2	15%	100%	15%
Measure 3	10%	100%	10%
Measure 4	10%	100%	10%
Measure 5	20%	0%	0%
Measure 6	5%	100%	5%
Measure 7 (SDOH Screening)	10%	100%	10%
Measure 8	5%	0%	0%
Measure 9	10%	100%	10%
Measure 10	10%	100%	10%
Overall AE Quality Score			75%

After Year 1: After Year 1, the Quality Score Determination for specialized LTSS AEs will be designed to both reward high-quality providers and create opportunities for low performers to benefit from improvement. It will also shift the emphasis from reporting to performance. The requirements will be updated in the future to describe how the Overall AE Quality Score will be calculated. However, the approach will be aligned with the comprehensive AE approach to the extent feasible and practical.

Proposed Medicaid Specialized LTSS AE Common Measure Slate

Measure Name	Preliminary Measure Description
1. Depression Screening and Follow-up	% of attributed population who were screened for clinical depression using a standardized tool, and received appropriate follow-up care within 30 days if positive

Proposed Medicaid Specialized LTSS AE Common Measure Slate

Measure Name	Preliminary Measure Description
2. Falls with Major Injury	% of attributed population experiencing one or more falls with major injury
3. Advanced Care Planning	% of attributed population 65 years and older who have an advance care plan or surrogate decision maker documented in the medical record or documentation in the medical record that an advance care plan was discussed but the patient did not wish or was not able to name a surrogate decision maker or provide an advance care plan
4. Discharge to the Community from Nursing Home	% of short-stay residents attributed to the AE who were successfully discharged to the community
5. ED Utilization	Rate of emergency department visits (that do not result in inpatient stays) among the attributed population
6. 30-Day All-Cause Readmission	% of acute inpatient stays among the attributed population that were followed by an unplanned acute readmission for any diagnosis within 30 days
7. Social Determinants of Health (SDOH) Screening	% of attributed population screened as defined per the SDOH elements in the Medicaid AE certification standards*
8. Patient/Client Satisfaction	Average patient/client satisfaction rating among the attributed population
9. Caregiver Support/ Caregiver Burden	To be determined
10. Social Isolation	To be determined

*Section 5.2.2 of the AE Certification Standards requires that each AE:

“Together with partner MCOs, develop, implement, and maintain procedures for completing an initial SDOH Care Needs Screening for Attributed Members based on a defined protocol.... The screening shall evaluate Attributed Members’ health-related social needs in order to determine the need for social service intervention. Such services shall include but not be limited to:

- *Housing stabilization and support services;*
- *Housing search and placement;*
- *Food security;*
- *Support for Attributed Members who have experience of violence.*
- *Utility assistance;*
- *Physical activity and nutrition... ”*

Attachment I: Infrastructure Incentive Program: Requirements for Managed Care Organizations and Certified Accountable Entities

Table of Contents

- I. Background and Context
- II. Medicaid Infrastructure Incentive Program
- III. Determining Maximum Incentive Pool Funds
- IV. AE Specific Health System Transformation Project Plans
- V. EOHHS Priorities
- VI. Allowable Areas of Expenditures
- VII. Required Performance Areas and Milestones

EOHHS Incentive Program Requirements

I. Background and Context

Beginning in late 2015, the Rhode Island (RI) Executive Office of Health and Human Services (EOHHS) began pursuing Medicaid waiver financing to provide support for Accountable Entities (AEs) by creating a pool of funds primarily focused on assisting in the design, development and implementation of the infrastructure needed to support Accountable Entities. RI submitted an application for such funding in early 2016 as an amendment to RI's current Global Medicaid 1115 Waiver. In October 2016, the Centers for Medicare & Medicaid Services (CMS) approved this waiver amendment, bringing \$129.8 million in Federal Financial Participation (FFP) to RI from November 2016 through December 2020.¹⁰

This funding is based on the establishment of an innovative **Health Workforce Partnership** with RI's three public institutions of higher education (IHE): University of Rhode Island (URI), Rhode Island College (RIC), and the Community College of Rhode Island (CCRI), as illustrated below.

Health System Transformation Project

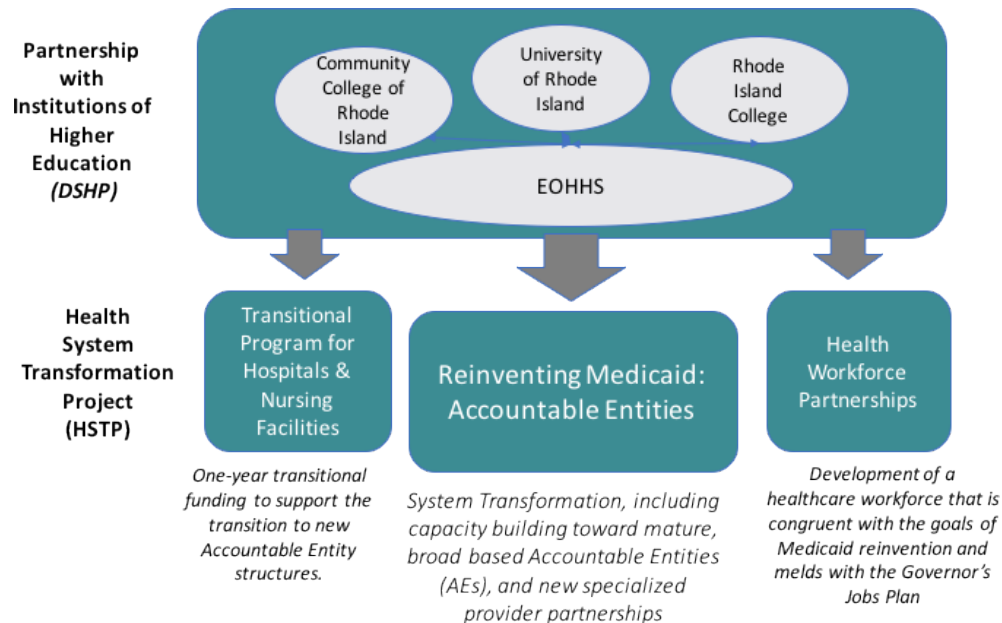

The majority of the financing from this waiver amendment will be provided to AEs as incentive-based infrastructure funding via the state's managed care contracts. Other CMS supported components include:

¹⁰ The current Rhode Island 1115 Waiver is a 5-year demonstration, ending 12/31/2018. The STCs include DSHP funding authority through 2018, with a commitment articulated in the cover letter to extend this authority thru 2020 upon waiver renewal for a total funding opportunity of \$129 Million.

- Investments in partnerships with Institutions of Higher Education (IHEs) for statewide health workforce development and technical assistance to AEs
- One-time funding to support hospitals and nursing facilities with the transition to new AE structures¹¹
- Project management support to ensure effective and timely design, development and implementation of this program
- Project demonstration pilots and project evaluation funding to support continuous program learning, advancement and refinement
- Other supporting programs, including Consumer Assistance, Wavemaker Fellowship, TB Clinic, RI Child Audiology Center, and Center for Acute Infectious Disease Epidemiology

As mentioned above, the current RI 1115 Waiver expires December 31, 2018. The Special Terms and Conditions (STCs) of the waiver amendment include expenditure authority for this program of up to \$79.9 million FFP through the end date of the current waiver.

II. Medicaid Infrastructure Incentive Program (MIIP)

Over the course of program years 1 through 4 EOHHS projects it will allocate an estimated \$95 million to the AE program through the Medicaid Infrastructure Incentive Program (MIIP), as shown below. This allocation is subject to available funds captured in accordance with CMS approved claiming protocols, and annual EOHHS review and approval. This program shall begin no earlier than January 2018 and shall be aligned with the state fiscal years as shown below. Note that Program Year 1 is an extended performance period to allow for differential start dates; as such it must begin no earlier than January 1, 2018 and no later than July 1, 2018 and must end on June 30, 2019.

	Program Year 1 SFY 2018-19 <i>Jan 2018- Jun2019</i>	Program Year 2 SFY 2020 <i>Jul 2019- Jun 2020</i>	Program Year 3 SFY 2021 <i>Jul 2020-Jun 2021</i>	Program Year 4 SFY 2022 <i>Jul 2021-Jun 2022</i>	Total
Medicaid Infrastructure Incentive Program (MIIP)	\$30 M	\$30 M	\$20 M	\$15 M	\$95 M

An AE Program Advisory Committee shall be established by EOHHS.

This committee shall be chaired by EOHHS, with a community Co-Chair and shall include representation from participating managed care organizations (MCOs), AEs, and community stakeholders and shall:

- Support the development of AE infrastructure priorities

¹¹ The STCs limit this program to be one-time only and to not exceed \$20.5 million, paid on or before December 31, 2017.

- Help target Medicaid Infrastructure Incentive Program funds to specific priorities that maximize impact
- Review specific uses of funds by each AE and MCO, such that individual AE Project plans are designed and implemented to maximum effect
- Support effective program evaluation and integrated learnings
- Identify effective ways to leverage the intersection between AE project plans and workforce development partnerships

The MIIP shall consist of three core programs:

(1) Comprehensive AE Program; (2) Specialized LTSS AE Pilot Program; and (3) Specialized Pre-eligibles AE Pilot Program. EOHHS shall allocate available HSTP funds to these three programs as follows, subject to available funds and EOHHS identification of priority areas of focus and assessment of readiness. This allocation shall be revisited annually.

AE Programs	Program Year 1		Full Program
	\$	%	
Comprehensive AE Program	\$21 M	65-70%*	60% - 70%
Specialized LTSS Pilot AE Program	\$9 M	30-35%*	25% - 35%
Specialized Pre-eligibles Pilot AE Program**	\$0 M	0%	5%-15%
Total Funds	\$30 M	100%	100%

*For the purposes of illustration, PY 1 assumes a 70/30 distribution of funds between the Comprehensive AE Program and the Specialized LTSS AE Pilot Program

**Authority for this program is dependent upon CMS approval under the RI Medicaid 1115 waiver renewal, to be submitted to CMS in December 2017, effective 1/1/2019.

AEs participating in both the Comprehensive AE Program and Specialized LTSS Pilot AE Program will be eligible to receive funding from both incentive pools.

III. Determining Maximum Incentive Pool Funds

The MIIP shall include three dimensions:

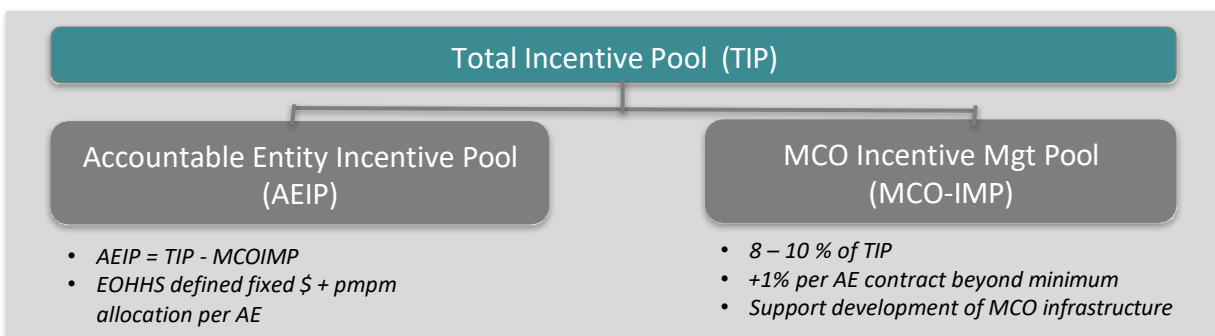

Maximum Total Incentive Pool (TIP)

The maximum Total Incentive Pool (TIP) is provided in the table below. This TIP shall be

allocated to each MCO by EOHHS with consideration of the MCO share of AE attributed lives in accordance with EOHHS defined attribution guidelines and associated reports.

1. MCO Incentive Management Pool (MCO-IMP)

Assuming satisfactory MCO performance, the MCO Incentive Management Pool that can be earned by the MCO shall be eight percent (8%) of the Total Incentive Pool. However, to the degree that the MCO has more than the minimally required number of contracts with AEs, the maximum MCO-IMP shall be increased by one percent for each AE contract to a maximum of ten percent (10%). These funds are intended for use toward advancing program success, including program administration and oversight, assisting with the development of the necessary infrastructure to support a new business model, and establishing shared responsibilities, information requirements and reporting between EOHHS, the MCO and the Accountable Entities.

2. Accountable Entity Incentive Pool (AEIP)

The Accountable Entity Incentive Pool shall equal the Total Incentive Pool minus the maximum MCO Incentive Program Management Pool (AEIP = TIP – MCO-IMP). This shall

MIIP Funds Program Year 1 <i>Jan 2018-Jun2019</i>	Accountable Entity Incentive Pool (AEIP)	MCO Incentive Management Pool (MCO-IMP)	Total Incentive Pool (TIP)
Comprehensive AE Program	\$18.9 M	\$ 2.1 M	\$21.0 M
Specialized LTSS Pilot Program	\$8.1 M	\$0.9 M	\$9.0 M
Total Funds	\$27.0 M	\$3.0 M	\$30.0 M
<i>% Total</i>	<i>90%</i>	<i>10%</i>	<i>100%</i>

determine the total annual amount and schedule of incentive payments each participating AE may be eligible to receive from the Accountable Entity Incentive Pool.

Consistent with this structure, Program Year 1 MIIP funds shall be allocated as follows, subject to available funds:

AE-Specific Incentive Pools

Certified AEs in qualified Alternative Payment Methodology (APM) contracts consistent with EOHHS requirements must be eligible to participate in the Medicaid Infrastructure Incentive Program. Each MCO must create an AE-Specific Incentive Pool for each Certified AE to establish the total incentive dollars that may be earned by each AE during the period.

For Program Year 1, this AE Specific Incentive Pool shall be calculated by the MCOs as follows:

- **Comprehensive AE- Specific Incentive Pools** shall be the sum of two pieces (a) an incentive pool amount derived from a per member per month (PMPM) times the number of attributed lives in accordance with the following formula, plus (b) a fixed-amount base incentive pool per AE.

•

Estimated PMPM*	x Attributed Lives	x 12	+ Estimated Base Incentive Pool*
\$8.00	At the start of each Program Year in accordance with EOHHS defined requirements	Translate to Member Month	\$750,000 Fixed Amount per AE

*Note that the PMPM and base incentive pool are dependent upon the number of Certified AEs and the total attributed lives in the AE program. As such, these amounts are only estimates, and shall be finalized by EOHHS within 30 days of AE Certification.

- **The Specialized LTSS Pilot AE-Specific Incentive Pool** shall be determined on a per AE basis, in accordance with the formula below. The pool funding depends upon the number of Certified participating LTSS Pilot AEs as follows. This pool structure shall be finalized by EOHHS within 30 days of AE Certification. If there are fewer than four (4) certified AEs, the funds per AE remain unchanged, and any unallocated funds will be retained for future Specialized AE program use.

# Certified LTSS AEs	Program Year 1 Total \$ Per Certified LTSS AE
2	\$2.0 M
3	\$2.0 M
4	\$2.0 M
5	\$1.6 M
6	\$1.4 M

Note that the Specialized LTSS Program is a pilot, and as such is intended to both enhance core capabilities and provide a basis for testing the validity of the APM model. As such, 20% of the AE Specific Incentive Pool shall be set aside to support the potential shared savings associated with each AE’s Total Cost of Care target, inclusive of the required quality multiplier, in accordance with state defined APM requirements, as specified in Section F of this document.

IV. AE Specific Health System Transformation Project Plans (HSTP Plans)

Under the terms of Rhode Island’s agreement with the federal government, this is not a grant program. AEs must earn payments by meeting metrics defined by EOHHS and its managed care partners, and approved by CMS to secure full funding.

Certified AEs and MCOs must jointly develop individual Health System Transformation Project Plans (HSTP Plans) that identify clear project objectives and specify the activities and timelines for achieving the proposed objectives. Actual AEIP incentive payment amounts to AEs will be based on demonstrated AE performance, accordingly, incentive payments actually earned by the AE may be less than the amount they are potentially eligible to earn. MCOs shall not be entitled to any portion of funds from the Accountable Entity Incentive Pool that are not earned by the

AE. Any monies not remitted to an AE from the Accountable Entity Incentive Pool must be returned to EOHHS.

Specifications Regarding Allowable AE Specific HSTP Project Plans

Approvable HSTP Project Plans must specify:

- **Core Goals**

Approvable project plans must demonstrate how the project will advance the core goals of the Health System Transformation Project and identify clear objectives and steps for achieving the goals.

- **Data Driven Identification of Shared MCO/AE Priorities**

Plan must identify a set of shared MCO/AE priorities based on population specific analysis of service needs, capabilities and key performance indicators. To inform this work the MCO shall provide a population specific analysis of the AE's attributed population. The data driven assessment may provide a basis for risk segmentation of the population served by the AE that can help guide project plans. Data analyses may identify patterns of gaps in coordinated care for population subgroups such as adults with co-occurring medical and behavioral health needs and/or may identify avoidable inpatient or emergency department utilization in specific geographic areas. Project plans then focus on tangible projects within the certification domain areas, such as IT capability to identify and track needs or strengthen targeted care management or patient engagement processes. This provides for the linkage between recognized areas of need/opportunity and developmental tasks. Shared priorities must be developed through a joint MCO/AE working group that includes clinical leadership from both the MCO and the AE¹² and using a data driven approach to consider issues such as:

- EOHHS priorities, as defined in Section D
- Data driven assessment of the specific needs of the population served by the AE
- The service profile of the AE (current and proposed)
- Specific gaps in AE capacities and capabilities as defined in the AE Certification Application
- Key Performance gaps, in quality and outcomes, relative to the populations served
- Areas of potential enhancement of workforce skill sets to better enable system transformation

- **AE Specific Core Projects: Workplan and Budget**

The AE must develop a multi-year workplan and budget to address these priorities over the course of the program (Program Year 1-4). A more detailed workplan and budget must be developed for Program Year 1 that identifies a requested set of core projects in the pertinent Domains needed to address the Shared MCO/AE Priorities. Workplan objectives for Program Years 2-4 would be at a higher level with increased refinement for the subsequent periods. To avoid duplication of funds, each core project must be MCO specific, and must specify the requested **Areas of Expenditure consistent with requirements in Section E.**

¹² Note: Membership in this Working Group shall be specified in the AE application, as a condition of certification.

- **Performance Areas and Milestones**

Approvable project plans must set milestones and deadlines for the meeting of metrics associated with each of the Core Projects to ensure timely performance, **consistent with requirements in Section F.**

MCO Review Committee Guidelines for Evaluation

The MCO shall convene a review committee to evaluate the Detailed Workplan and Budget described above. EOHHS shall have a designee that participates on the MCO evaluation committee to ensure the state's engagement in the evaluation of the project plan and associated recommendations for approval or disapproval. The MCO Review Committee, in accordance with EOHHS guidelines, shall determine whether:

- **Core Projects as submitted are eligible for award**

Eligible core projects will include a workplan that clearly addresses EOHHS priority areas and includes the types of activities targeted for funds.

- **Core Projects that merit Incentive Funding**

Projects must show appropriateness for this program by including the following:

- Clear statement of understanding of the intent of incentive dollars
- Rationale for this incentive opportunity, including a clear description of the objective for the project and how achieving that objective will promote health system transformation for that AE
- Confirmation that the project does not supplant funding from any other source and that project funding is non-duplicative of any submissions made to another MCO
- The inclusion of a gap analysis and an explanation of how the workplan and associated incentive plan and budget address these gaps
- Clear interim and final project milestones and projected impacts, as well as criteria for recognizing achievement of these milestones and quantifying these impacts

- **Incentive Funding request is reasonable and appropriate**

The funding request must be reasonable for the project identified, with funds clearly dedicated to this project. The level and apportionment of the incentive funding request must be commensurate with value and level of effort required.

At the discretion of the EOHHS designee, the designee may refer the proposed project for EOHHS review and approval prior to development of the subcontract between the MCO and the AE.

Development of the proposed project plan and its acceptance by the MCO Review Committee shall be considered a Performance Milestone of the HSTP Program, as specified in Section F.

Required Structure for Implementation

The Incentive Funding Request **must be awarded to the AE via a Contract Amendment** between the MCO and the AE. The Contract Amendment shall:

- Be subject to EOHHS review and approval
- Incorporate the central elements of the approved AE submission, including:
 - Stipulation of program objective

- Scope of activity to achieve (may be incorporated via reference to separate project plan)
 - Performance schedule and performance metrics
 - Payment terms – basis for earning incentive payment(s) commensurate with the value and level of effort required.
- Define a review process and timeline to evaluate progress and determine whether AE performance warrants incentive payments. The MCO must certify that an AE has met its approved metrics as a condition for the release of associated Health System Transformation Project funds to the AE.
 - Minimally require that AEs submit semi-annual reports to the MCO using a standard reporting form to document progress in meeting quality and cost objectives that would entitle the AE to qualify to receive Health System Transformation Project payments; such reports will be provided to EOHHS by the MCO.¹³
 - Stipulate that the AE earn payments through demonstrated performance. The AE’s failure to fully meet a performance metric under its AE Health System Transformation Project Plan within the timeframe specified will result in forfeiture of the associated incentive payment (i.e. there will be no payment for partial fulfillment).
 - Provide a process by which an AE that fails to meet a performance metric in a timely manner (thereby forfeiting the associated Health System Transformation Project Payment) can reclaim the payment at a later point in time (not to exceed one year after the original performance deadline) by fully achieving the original metric in combination with timely performance on a subsequent related metric.

Reconciliation

In advance of the MCOs payments to AEs, the MCO shall receive payment from EOHHS in the amount and schedule agreed upon with EOHHS. MCOs shall make associated payments to AEs within thirty (30) calendar days of receipt of payment. The MCO will maintain a report of funds received and disbursed by transaction in a format and in the level of detail specified by EOHHS. Within fifteen days after the end of each calendar quarter, the MCO will provide the report to EOHHS for reconciliation. The MCO will work with EOHHS to resolve any discrepancies within fifteen calendar days of notification of such discrepancy. Any Incentive Program funds that are not earned by EOHHS Certified AEs as planned will be returned to EOHHS within thirty days of such request by EOHHS. An AE’s failure to fully meet a performance metric within the time frame specified will result in forfeiture of the associated incentive payment (i.e., no payment for partial fulfillment). An AE that fails to meet a performance metric in a timely fashion can earn the incentive payment at a later point in time (not to exceed one year after the original performance deadline) by fully achieving the original metric in combination with timely performance on a subsequent related metric.

Project Plan Modifications

Subcontracts between the AE and the MCO associated with AE-specific HSTP Project Plans may only be modified with state approval. EOHHS may require that a plan be modified if it

¹³ Reporting templates will be developed in partnership with EOHHS

becomes evident that the previous targeting/estimation is no longer appropriate or that targets were greatly exceeded or underachieved.

V. EOHHS Priorities

Each MCO’s AE Incentive Pool budget and actual spending must align with the priorities of EOHHS as developed with the support of the Advisory Committee and shown below. Note: This is a draft set of priorities – a final set of priorities shall be reviewed by the Advisory Committee and confirmed by EOHHS.

Program	Priorities
Comprehensive AEs	<ul style="list-style-type: none"> • Integration and innovation in behavioral health care • Integration and innovation in SUD treatment • Integration and intervention in social determinants, including cross system impacts
Specialized Pilot LTSS AEs	<ul style="list-style-type: none"> • Developing programs and care coordination processes to enable people to reside safely in a community setting and to promote timely care transitions and reduced institutional/ED utilization • Home and Community based Behavioral Health capacity development for specialized adult day care, home care, and alternative living arrangements with capacity to serve members with behavioral health and/or dementia/Alzheimer’s related service needs • Repurposing skilled nursing capacity for acute psychiatric transitions and/or adult day capacity

Consistent with these priorities and the requirements of the AE Certification Standards, Comprehensive AEs shall be required to demonstrate that at least 10% of Program Year 1 Incentive funds are allocated to partners who provide specialized services to support behavioral health care, substance abuse treatment and/or social determinants.

VI. Allowable Areas of Expenditure

Allowable uses of funds include the following three core areas and eight domains. Costs must be reasonable for services rendered.

EOHHS anticipates that some AEs incentives in Program Year 1 may be weighted toward development in core readiness domains 1-3 as set forth in the certification standards, as AEs build the capacity and tools required for effective system transformation. However, over time the allowable areas of expenditure will be required to shift toward system transformation capacities (domains 4-8). As such, in Program Year 1, allowable Readiness Expenditures (Category A, Domains 1 through 3 below), are limited as follows:

- Comprehensive AEs may devote no more than 30% of the total HSTP incentive pool to projects in the in the readiness category (Domains 1-3)
- Specialized AEs may devote no more than 60% of the total HSTP incentive pool to projects in the readiness category (Domains 1-3)

	Domains	Allowable Uses of Funds
A. Readiness	1. Breadth and Characteristics of Participating Providers	<ul style="list-style-type: none"> • Building provider base, population specific provider capacity, interdisciplinary partnerships, developing a defined affiliation with community based organizations (CBOs) • Developing full continuum of services, Integrated PH/BH, Social determinants
	2. Corporate Structure and Governance	<ul style="list-style-type: none"> • Establishing a distinct corporation, with interdisciplinary partners joined in a common enterprise
	3. Leadership and Management	<ul style="list-style-type: none"> • Establishing an initial management structure/staffing profile • Developing ability to manage care under Total Cost of Care (TCOC) arrangement with increased risk and responsibility
B. IT Infrastructure*	4. Data Analytic Capacity and Deployment	<ul style="list-style-type: none"> • Building core infrastructure: EHR capacity, patient registries, Current Care • Provider/care managers’ access to information: Lookup capability, medication lists, shared messaging, referral management, alerts • Patient portal • Analytics for population segmentation, risk stratification, predictive modeling • Integrating analytic work with clinical care: Clinical decision support tools, early warning systems, dashboard, alerts • Staff development and training – individual/team drill downs re: conformance with accepted standards of care, deviations from best practice
C. System Transformation	5. Commitment to Population Health and System Transformation	<ul style="list-style-type: none"> • Developing an integrated strategic plan for population health that is population based, data driven, evidence based, client centered, recognizes Social Determinants of Health, team based, integrates BH, IDs risk factors • Healthcare workforce planning and programming
	6. Integrated Care Management	<ul style="list-style-type: none"> • Systematic process to ID patients for care management • Defined Coordinated Care Team, with specialized expertise and staff for distinct subpopulations • Individualized person-centered care plan for high risk members
	7. Member Engagement and Access	<ul style="list-style-type: none"> • Defined strategies to maximize effective member contact and engagement • Use of new technologies for member engagement, health status

		monitoring and health promotion
	8. Quality Management	<ul style="list-style-type: none"> Defined quality assessment & improvement plan, overseen by quality committee

* The state may make direct investments in certain technology to support provider to provider EHR communication, such as dashboards and alerts. This investment would be made directly by the state with vendor(s) which would have the capacity and expertise to create and implement this technology in AEs statewide. This may be done in certain technology areas where direct purchasing by the state would result in significant efficiencies and cost savings. The products and tools resulting from this direct state technology investment would be made available to all AEs at no upfront charge. AEs would have the choice to either utilize the statewide tool at no charge or pay for their own tool. In this case, DSRIP funds would not be available for the AE to separately purchase such a tool.

Note that the allowable uses of funds specified above may not include any of the following expenditures:

- Alcoholic beverages
- Capital expenditures (unless approved in advance by EOHHS)
- Debt restructuring and bad debt
- Defense and prosecution of criminal and civil proceedings, and claims
- Donations and contributions
- Entertainment
- Fines and penalties
- Fund raising and investment management costs
- Goods or services for personal use
- Idle facilities and idle capacity
- Insurance and indemnification
- Interest expense
- Lobbying
- Marketing/member communication expense, unless approved in advance by EOHHS
- Memberships and subscription costs
- Patent costs

These non-allowable expenditures have been developed in alignment with Section 2 CFR 200 which outlines Financial Management and Internal Control Requirements for receipt, tracking and use of federal funds by non-Federal awardees, and shall be updated by EOHHS as appropriate.

VII. Required Performance Areas and Milestones

AEs must develop AE Specific Health System Transformation Project Plans. These plans shall specify the performance that would qualify an AE to earn incentive payments. The execution of an EOHHS qualified APM contract with the MCO shall be considered the first Performance Milestone of the HSTP Program, as shown below.

Earned funds shall be awarded by the MCO to the AE in accordance with the distribution by performance area defined in the AE specific Health System Transformation Plan, consistent with the requirements defined below:

Performance Area	Minimum Milestones	Program Year 1
Developmental Milestones	<ul style="list-style-type: none"> • Execution of an EOHHS qualified APM contract with the MCO, including performance milestones agreed upon by both parties • Detailed Health System Transformation Project Plan, including a specified set of Core Projects, and a proposed Infrastructure Development Budget by Project and Domain in accordance with state specified template • Quarterly Progress and Financial Reports in accordance with state defined template • Developmental milestones MCO/AE Defined (at least 3 unique developmental milestones per Core Project per year) 	75%
Value based purchasing metrics	<ul style="list-style-type: none"> • Demonstrated APM Progression, development of defined modeling capabilities to manage care under a TCOC approach • Marginal Risk Requirements • Minimum required share of marginal risk for which the AE is liable, in accordance with EOHHS define APM guidelines 	5%
Outcome Metrics*	<p>Comprehensive</p> <ul style="list-style-type: none"> • Preventable Admissions • Readmissions • Avoidable ED Use • MCO/AE Specific Performance Targets <p>Specialized</p> <ul style="list-style-type: none"> • Total Cost of Care, inclusive of quality multiplier, in accordance with state defined APM requirements • Preventable Admissions • Readmissions 	20%

	<ul style="list-style-type: none"> • Completion of Advanced Directives 	
Total		100%

*Note: For Program Year 1, at least 50% of the performance goals on outcome metrics shall be based on reporting only (for both Comprehensive and Specialized LTSS AEs).

The early milestones are intended to allow AEs to develop the foundational tools and human resources that will enable AEs to build core competencies and capacity. In accordance with EOHHS’ agreement with CMS, participating AEs must fully meet milestones established in the AE specific Health System Transformation Project prior to payment. EOHHS recognizes the financial constraints of many participating AEs and that timely payment for the achievement of early milestones will be critical to program success.

Attachment J: Accountable Entity Attribution Requirements

Table of Contents

J. Attribution Overview

1.1 Attribution Methodology Goals

K. Background

L. Comprehensive AE Attribution

3.1. Population Eligible for Attribution to a Comprehensive AE

3.2. Certified Comprehensive AE-Identified Providers

3.3 Hierarchy of Attribution for Comprehensive AEs

M. Specialized LTSS AE Attribution

4.1. Population Eligible for Attribution to a Specialized LTSS AE

4.2. Certified Specialized LTSS AE -Identified Providers

4.3 Attribution Methodology for Specialized LTSS AEs

Attachments

- Attachment A: Excerpts from EOHHS-MCO Contracts Regarding Assignment of Primary Care Providers
- Attachment B: Qualifying Primary Care Services as Identified by CPT Codes

1. Attribution Overview

Attribution is the process of defining the population on which total costs are calculated for the purposes of identifying savings under a shared savings or risk contract. Effective attribution provides an incentive for providers and Accountable Entities (AEs) to invest in care management and other appropriate services to keep their attributed population well, with the intention of earning savings by lowering total costs and ensuring high quality care. Attribution does not affect consumers' freedom to choose or change their providers at any point in their care. However, AEs are expected to have continuing responsibility for the care and outcomes of their attributed members on an on-going basis, unless there is a compelling reason for that responsibility to change.

1.1. Attribution Methodology Goals

The attribution method, to be applied across all Managed Care Organizations (MCOs) and AEs, is intended to:

- Allow providers who have identified responsibility for member costs to earn savings by reducing those costs in the future;
- Allow Integrated Health Homes (IHH) to assume this responsibility for members with an approved IHH diagnosis and to allow Long-Term Services and Supports (LTSS) providers to assume this responsibility for members receiving certain long-term care services; and
- Be transparent and understandable to all program participants.

2. Background

Attribution is the foundation of the linkage of the member to an AE. Attribution identifies the population that the AE is accountable for in the overall AE program. This includes accountability of the AE for the health and health care for that person as represented in access, quality, and total cost of care metrics. The program intent is to recognize and strengthen an existing relationship of the member with the AE and its clinical programs. For comprehensive AEs, it is also to establish the basis for such relationship for members who do not have an established relationship with a primary care provider (PCP).

The foundations for attribution are:

- A population of Medicaid beneficiaries eligible for attribution.
- A defined provider roster of the certified AE to which members may be attributed.
 - Each certified AE will have a defined roster of providers that will qualify the AE for attributed members.
 - For comprehensive AEs, the provider roster will consist of:
 - IHH providers as licensed by the Department of Behavioral Health, Developmental Disabilities, and Hospitals (BHDDH) if an IHH is a recognized Partner Provider or Affiliate Provider in the AE; and

- PCPs, as described in Section 3.2, at a Partner Provider or Affiliate Provider in the AE.
 - For specialized LTSS AEs, the provider roster will consist of agencies licensed by the Rhode Island Department of Health to provide one or more of the attributable services listed in Table A in Section 4.2.
- A clear methodology for attribution of eligible members to a certified AE.
 - For comprehensive AEs, this includes:
 - MCO algorithm for initial PCP assignment and attribution; and
 - Methodology for updated attribution based on utilization of identified primary care services provided by an eligible PCP.
 - For specialized LTSS AEs, this includes:
 - Monthly attribution based on service authorizations; and
 - AE validation of the attribution.

These attribution requirements set forth the basis for:

- (a) Identifying the specific AE provider roster eligible for attribution; and
- (b) The basis for attribution of members to the AE.

An attribution-eligible provider can only participate in one comprehensive AE at a time for the purposes of attribution. An attribution-eligible provider can only participate in one specialized LTSS AE at a time for the purposes of attribution.

A member can only be attributed to a single comprehensive AE at a time. A member can only be attributed to a single specialized LTSS AE at a time. However, a member who meets the requirements for attribution to both a comprehensive AE and a specialized LTSS AE at the same time will be attributed to both AEs.

3. Comprehensive AE Attribution

3.1. Population Eligible for Attribution to a Comprehensive AE

The population eligible for attribution to a comprehensive AE consists of all Medicaid-only beneficiaries enrolled in managed care. Rhody Health Options (RHO) members shall be included in AE attribution if the RHO member is receiving Medicaid benefits only (not Medicare). RHO and Medicare-Medicaid Plan members who have both Medicare and Medicaid coverage are not eligible for attribution to a comprehensive AE.

3.2. Certified Comprehensive AE-Identified Providers

Attribution of members to comprehensive AE's will be based on the defined roster of providers included within the structure of the AE. For IHHs, recognition by BHDDH as a qualified IHH will be the basis for attributing members to the AE.

For primary care, each AE shall have a defined roster of PCPs. A PCP is defined as the individual plan physician or team selected by or assigned to the member to provide and coordinate all the member's health care needs and to initiate and monitor referrals for specialized services when required. PCPs are Medical Doctors or Doctors of Osteopathy in the following specialties: family and general practice, pediatrics, internal medicine, or geriatrics who have a demonstrated clinical relationship as the principal coordinator of care for children or adults and who have contracted with the MCO to undertake the responsibilities of serving as a PCP as stipulated in the MCO's primary care agreements. PCPs shall also meet the credentialing criteria established by the MCO and approved by EOHHS. In addition to physicians, the PCP may be a nurse practitioner, physician assistant, or a Federally Qualified Health Center (FQHC). Clinicians included in the provider roster shall be identified by TIN and by NPI.

AEs that include FQHCs are required to provide, through an attestation, a list of the clinicians' NPIs that provide direct patient primary care services in an FQHC. This attestation will be part of the application process for all comprehensive AEs and shall be updated minimally on a quarterly basis.

3.3. Hierarchy of Attribution for Comprehensive AEs

Members will be attributed to a comprehensive AE as follows:

Assignment Hierarchy

1st: IHH Assignment

If a member is assigned to an IHH, and that IHH is a part of a comprehensive AE, then the member is attributed to that AE. IHH assignment is based on monthly roster produced by BHDDH and provided to the MCO. IHH assignment is based on two sequential steps.

- Step 1: Assignment to the AE based on assignment to IHH, as determined by BHDDH. Note that IHH based attribution is inclusive of persons utilizing ACT services.
- Step 2: Quarterly Updates to that assignment
 - A member attributed to an AE based on assignment to an IHH shall continue to be attributed to that AE for one year following IHH discharge unless:
 - The member is assigned by BHDDH to a different IHH;
 - The member requests that the MCO change his or her PCP to one that is participating in an AE.

2nd: PCP Assignment by the MCO

PCP assignment by the MCO will be based on two sequential steps:

- Step 1: PCP assignment by the MCO at the point of entry by the member into the MCO
- Step 2: Quarterly updates to that assignment based on:
 - Member requests to the MCO to change his or her PCP; and

- Analyses of actual patterns of utilization that demonstrate member use of a different PCP than the one assigned by the MCO.

Step 1: Assignment by the MCO at the point of entry into the MCO

A fundamental requirement of EOHHS' contract with the MCO is that, to ensure the member's timely ability to meaningfully access health care services, the MCO must ensure that the member has an identified PCP. The challenge for the MCO is that the MCO has very limited information about whether a new member has an established relationship with, or preference for assignment to, a specific PCP. The MCO contract sets forth certain requirements on procedures for PCP assignment that are intended to promote an appropriate PCP assignment for the member (see Attachment A). A member may change his or her PCP assignment at any time, and MCOs routinely inform members of their right to change PCPs at any time upon request.

Step 2: Quarterly updates to PCP assignment and attribution based on:

- Member requests that the MCO change the PCP to one that is not participating in the AE
- Analyses of actual patterns of utilization that demonstrate member use of a different PCP than the one assigned by the MCO

Despite best efforts by MCOs at initial PCP assignment and the ready accommodation of member requests for a change in the assigned PCP, there will be some differences between the assigned PCP of record and the actual pattern of primary care utilization by the member. MCOs will update attribution on a quarterly basis based on retrospective analysis of actual patterns of primary care use.

EOHHS establishes a stepwise attribution algorithm hierarchy to be used in updating the attribution. Requirements for PCP related attribution are as follows:

1. Attribution to the AE will be based on PCP assignment of record within the MCO. PCP assignment of record shall be based on:
 - 1.1. Original assignment by the MCO
 - 1.2. Change of PCP assignment of record based on a member's request to change PCP
 - 1.3. Change of PCP assignment of record based on analysis of the member's actual primary care utilization
2. Attribution based on actual primary care utilization:
 - 2.1. Not later than thirty days after the close of each calendar quarter, claims for eligible members shall be analyzed to identify the presence of visits to a PCP with qualifying primary care services as identified by CPT codes and/or FQHC encounter codes for the preceding twelve-month period (see Attachment B for qualifying CPT codes). The provider specialty must be a PCP eligible for attribution.
 - 2.2. Attribution will be at the AE level based on aggregating utilization across all TINs that are part of the AE roster of attributable providers. Multiple visits to PCPs within an AE will be aggregated to that AE.
 - 2.3. For attributed members that have received all their qualified primary care services from a qualified provider within the AE, the PCP assignment will be unchanged from the PCP assignment as recognized by the MCO.

- 2.4. For beneficiaries that have not received any primary care services during the period, the attribution will continue to be based on the MCO's PCP assignment.
- 2.5. The MCO will identify beneficiaries who have had at least two visits to a PCP with qualifying primary care services as described in 2.1 and received at least one primary care service from a PCP who is not a participating provider in the AE.
 - 2.5.1. For those beneficiaries, the attribution hierarchy will then be as follows:
 - 2.5.1.1. Where there are two or more visits to providers, attribution is based on a plurality of primary care visits, with attribution based on the AE providers or on the non-AE PCP providing the highest number of visits. If the AE's providers are tied for the highest number of visits, attribution will remain with the AE.

To be enrolled in Medicaid managed care, an individual must be Medicaid eligible. MCOs shall be required monthly to provide contracted AEs with electronic lists of attributed members, inclusive of identification of additions and deletions. These lists will be updated to reflect changes including new members, persons who have lost Medicaid eligibility, persons who have requested a PCP not included in the AE, and the results of quarterly updates to PCP assignment and attribution.

4. Specialized LTSS AE Attribution

4.1. Population Eligible for Attribution to a Specialized LTSS AE

The population eligible for attribution to a specialized LTSS AE consists of all adult (age 21 and older) Medicaid-only and Medicare-Medicaid beneficiaries enrolled in managed care, including the Medicare-Medicaid Plan, or receiving Medicaid benefits through Medicaid fee-for-service. Children under age 21 are not currently eligible for attribution to a specialized LTSS AE. An LTSS eligibility determination in the State Medicaid eligibility system is not required for attribution.

Note that the specialized LTSS AE program is a pilot program and as such, EOHHS intends to engage in a systematic review of the guidelines established below as the program develops.

4.2. Certified Specialized LTSS AE-Identified Providers

Attribution of members to a specialized LTSS AE will be based on the defined roster of providers included within the structure of the AE. Each AE shall have a defined roster of providers. For specialized LTSS AEs, the provider roster will consist of agencies licensed by the Rhode Island Department of Health to provide one or more of the attributable services listed in Table A. Actual attribution will depend on the composition of providers in the specialized LTSS AE.

Table A: Specialized LTSS AE Attributable Services and Billing Codes

Service Type	Attributable Services
Home and Community Based Services	<ul style="list-style-type: none"> • Home Care Services, including: <ul style="list-style-type: none"> ○ Homemaker Services <ul style="list-style-type: none"> ▪ S5130 ○ Home Health Aide/CNA/Attendant Care Services <ul style="list-style-type: none"> ▪ S5125 ▪ S9122 ▪ T1004 • Adult Day Health Services <ul style="list-style-type: none"> ○ S5100-S5109 • Assisted Living <ul style="list-style-type: none"> ○ T2031 • Supported Living Arrangements/Shared Living <ul style="list-style-type: none"> ○ S5136 ○ T2025 ○ T2028
Institutional Services	<ul style="list-style-type: none"> • Long-Stay/Custodial and Skilled Nursing Facility Care

Services managed by BHDDH for people with intellectual and developmental disabilities are excluded as attributable services.

4.3. Attribution Methodology for Specialized LTSS AEs

Attribution to a specialized LTSS AE will be based on two sequential steps each month:

- Step 1: Monthly attribution based on service authorizations; and
- Step 2: Validation of the attribution.

Step 1: Monthly attribution based on service authorizations

When a Medicaid beneficiary in Medicaid managed care or Medicaid fee-for-service receives any of the attributable services in Table A, a service authorization or approval is entered into one or more information systems used by the MCO or the State to manage beneficiaries’ services. For specialized LTSS AE attribution, this authorization and approval information will be used to link a beneficiary to a specific provider and will be used to attribute beneficiaries to a specialized LTSS AE monthly using the attribution requirements described below.

The initial attribution to the AE will be based on any active authorization or approval, as of the first day of the month, for a service listed in Table A with any provider on the AE roster. Monthly, the initial attribution will be updated to reflect new authorizations for services, changes in authorization, and changes in Medicaid eligibility. These updates will include people newly attributed to an AE, people who are removed from AE attribution, and people who move from the attribution for one AE to the attribution for another AE.

AEs are expected to have continuing responsibility for the care and outcomes of their patients on an on-going basis, unless there is a compelling reason for that responsibility to change.

Once attributed to a specialized LTSS AE, a Medicaid beneficiary will continue to be attributed monthly to the specialized LTSS AE for at least 9 months after the beneficiary stops receiving services from a provider in the specialized LTSS AE, unless there is a new authorization for a different attributable service with a provider in a different specialized LTSS AE. When this occurs, the attribution will be updated to the specialized LTSS AE that includes the provider with the new authorization after 90 days. If the new authorization begins more than 90 days after the terminated authorization ends, the attribution will be updated at the next monthly attribution update. Examples of attribution scenarios are provided for illustrative purposes in Table B.

Table B: Illustrative Examples of Specialized LTSS AE Attribution Scenarios

Scenario	Impact on Attribution	Example
<p>An authorization for an attributable service with a provider in an AE is terminated. Within three months of the authorization terminating, a new authorization for an attributable service with a provider in a different AE becomes effective.</p>	<p>The beneficiary’s will remain attributed to the AE that includes the provider with the terminated authorization for 90 days after the authorization is terminated. The attribution will be updated to the AE that includes the provider with the new authorization during the next monthly update that occurs 90 days after the first authorization is terminated.</p>	<p>Mary is receiving Home Care Services from a provider in AE 1. Her Home Care authorization is terminated when she has a Long-Stay/Custodial Nursing Facility admission on January 15 and a new authorization for a Long-Stay/Custodial Nursing Facility Care with a provider in AE 2 becomes effective. She remains in the facility for over 90 days. Mary’s attribution is updated from AE 1 to AE 2 in the attribution update that is effective May 1.</p>
<p>An authorization for an attributable service with a provider in an AE is terminated. More than three months after the authorization terminated, a new authorization for an attributable service with a provider in a different AE becomes effective.</p>	<p>The attribution will be updated to the AE that includes the new provider during the next monthly update that occurs after the new authorization is effective.</p>	<p>Sue is receiving Adult Day Health Services from a provider in AE 3. She stops going to this Adult Day Health Services provider on March 12. She begins going to another Adult Day Health Services Provider, which is part of AE 4, on August 16. Sue remains attributed to AE 3 until August 31. Her attribution is updated from AE 3 to AE 4 in the attribution update that is effective September 1.</p>

Table B: Illustrative Examples of Specialized LTSS AE Attribution Scenarios

Scenario	Impact on Attribution	Example
An authorization for an attributable service with a provider in an AE is terminated. There is no other active authorization for an attributable service for more than 9 months.	The beneficiary will remain attributed to the AE for 9 months after the authorization is terminated. The attribution will be updated to remove this person in the next monthly update that occurs 9 months after the authorization is terminated.	Eduardo is receiving Home Care Services from a provider in AE X. His Home Care authorization is terminated on April 20, 2018, and no other authorization for an attributable service is active for the next 9 months. Eduardo remains attributed to AE X for 9 months after April 20, 2018. He is removed from AE X's attribution in the attribution update that is effective May 1, 2019.

NOTE: Table B provides examples of some specialized LTSS AE attribution scenarios for illustrative purposes only. It is not intended to address all potential attribution scenarios.

Attribution to a specialized LTSS AE will be unaffected by changes in Medicaid managed care enrollment (e.g., moved from Medicaid fee-for-service to Rhody Health Options, moved from Rhody Health Options to the Medicare-Medicaid Plan), as long as the AE is contracted with the MCO/payer the beneficiary is enrolled in.

If a beneficiary has active authorizations for services from providers in different AEs at the same time, the hierarchy for attribution will be as follows:

1. If a beneficiary is authorized to receive Home Care Services from more than one agency, attribution will be to the AE that includes the provider authorized for the highest number of service hours. If there is a tie for the provider with the highest number of hours, attribution will be based on the provider that historically has provided the highest number of hours.
2. If a beneficiary is authorized to receive Adult Day Health Services and Home Care Services, attribution will be to the AE that includes the Adult Day Health provider if the beneficiary is receiving fewer than sixteen (16) hours per week of Home Care Services from a single provider. Otherwise, attribution will be based on the AE that includes the provider with the highest number of Home Care Services.
3. If an adult beneficiary is authorized to receive Adult Day Health Services and Shared Living Services, attribution will be to the AE that includes the Shared Living provider.

These guidelines apply to both the initial attribution and the monthly updates. Due to Medicaid rules related to service use, beneficiaries should not receive Home Care Services while receiving Shared Living, Assisted Living, or Nursing Facility services or receiving Adult Day Health Services while receiving Assisted Living or Nursing Facility services. Beneficiaries should also not receive Shared Living, Assisted Living, and Nursing Facility services simultaneously. As a result, the attribution hierarchy does not address those situations. In the event that a beneficiary is identified to have overlapping authorizations for these services, the MCO and/or EOHHS will validate the authorization information and ensure appropriate assignment. Where other

discrepancies in the attribution are identified, the MCO and/or EOHHS may also validate and adjust the assignment as needed on a case-by-case basis.

Figure 1 summarizes the attribution rules when beneficiaries receive specialized LTSS AE attributable services from two or more providers in different AEs at the same time.

Figure 1: Attributing Beneficiaries Who Simultaneously Receive Attributable Services from Providers in Different AEs

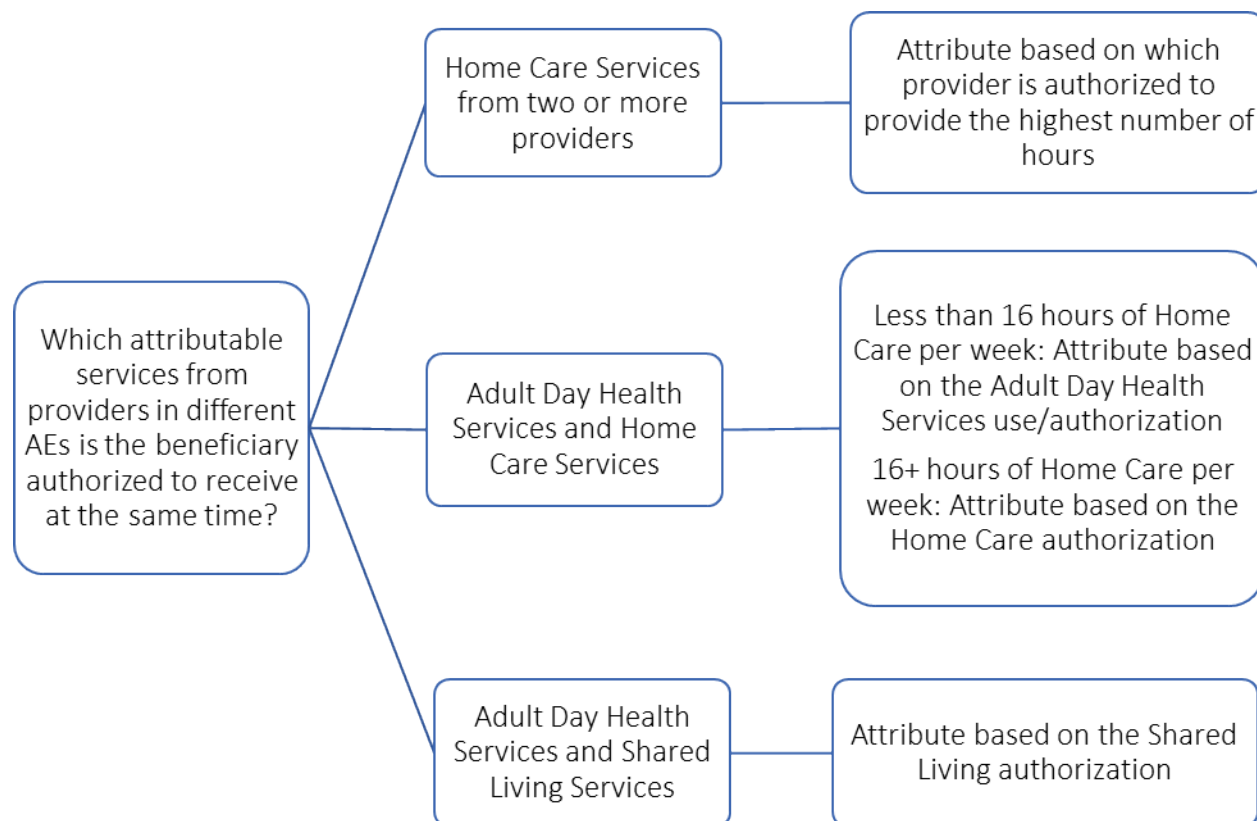

NOTE: Figure 1 addresses only those scenarios in which beneficiaries receive attributable services from multiple providers simultaneously. As a result, it does not reference all types of attributable services.

Step 2: Validation of the attribution

No more than 5 calendar days after the first day of each month, each AE will receive a list of all Medicaid beneficiaries attributed to the AE from each MCO/payer. The AE will have 5 business days to identify and report any person actively receiving any of the attributable services in Table A who is not included in the attribution list. The MCO (for managed care enrolled members) and the State or its designee (for Medicaid fee-for-service beneficiaries) will validate the AE-reported information and update the attribution list as appropriate. Where other discrepancies in the attribution list are identified, the MCO/payer may also validate and adjust the assignment as needed on a case-by-case basis.

To be attributed to a specialized LTSS AE, an individual must be Medicaid eligible. He or she may be receiving services through either managed care or fee-for-service. The MCO/payer shall

be required monthly to provide contracted AEs with electronic lists of attributed members, inclusive of identification of additions and deletions. These lists will be updated to reflect changes including new members, persons who have lost Medicaid eligibility, and persons whose attribution has changed pursuant to these guidelines.

Attachment A: Excerpts from EOHHS-MCO Contracts Regarding Assignment of Primary Care Providers

PCP assignment by the MCOs must comply with EOHHS contractual requirements. The following excerpts from Sections 2.05.07 and 2.05.08 of EOHHS' Medicaid Managed Care Services contracts with the MCOs describe the MCOs' contractual requirements related to PCP assignment:

2.05.07 Assignment of Primary Care Providers (PCPs)

Contractor shall have written policies and procedures for assigning each of its members who have not selected a primary care provider (PCP) at the time of enrollment to a PCP. The process must include at least the following features:

- The Contractor must allow each enrollee to choose his or her health professional to the extent possible and appropriate.
- If a Medicaid-only member does not select a PCP during enrollment, Contractor shall make an automatic assignment, taking into consideration such factors as current provider relationships, language needs (to the extent they are known), member's area of residence and the relative proximity of the PCP to the member's area of residence. Contractor then must notify the member in a timely manner by telephone or in writing of his/her PCP's name, location, and office telephone number, and how to change PCPs if desired. Contractor shall auto assign members to a NCQA recognized patient centered medical home, where possible.

Notwithstanding the above, the EOHHS recognizes the importance of members enrolling in a Patient Centered Medical Homes (PCMHs) and building a relationship with the Primary Care Provider (PCP). EOHHS expects that the Contractor to auto-assign to providers in a PCMH practice before auto assigning to non-PCMH providers. The Contractor will provide EOHHS with quarterly reports of the number and percent of total members assigned to PCMH sites either by auto-assignment or member choice. The Contractor is responsible for creating an auto-assignment algorithm and submitting this algorithm to EOHHS for review and approval within 90 days of the execution of this contract. Once this logic is approved by EOHHS, the health plan should operationalize this within 60 days. Contractor should consider the following when creating the algorithm:

- a) When auto assignment is being utilized, the Contractor must regularly monitor member panel size to ensure that providers have not exceeded their panel size; b) The provider's ability to comply with EOHHS's specified access standards, as well as the provider's ability to accommodate persons with disabilities or other special health needs must be considered during the auto-assignment process; c) In the event of a full panel or access issue, the algorithm for auto assignment must allow a provider to be skipped until the situation is resolved. Additionally, the Contractor will be required to provide registries of patients to each PCP facility where the patients are assigned, no less frequent than quarterly or at an interval defined by EOHHS.
- Contractor shall notify PCPs of newly assigned members in a timely manner.

- If a Medicaid-only member requests a change in his or her PCP, Contractor agrees to grant the request to the extent reasonable and practical and in accordance with its policies for other enrolled groups. It is EOHHS's preference that a member's reasonable request to change his or her PCP be effective the next business day.

Contractor shall make every effort to ensure a PCP is selected during the period between the notification to the Contractor by EOHHS and the effective date of the enrollee's enrollment in the Contractor's Health Plan. If a PCP has not been selected by the enrollee's effective date of enrollment, the Contractor will assign a PCP. In doing so, Contractor will review its records to determine whether the enrollee has a family member enrolled in the Contractor's Health Plan and, if so and appropriate, the family member's PCP will be assigned to the enrollee. If the enrollee does not have a family member enrolled in the Health Plan but the enrollee was previously a member of the Health Plan, the enrollee's previous PCP will be assigned by the Contractor to the enrollee, if appropriate.

2.05.08 Changing PCPs

Contractor shall have written policies and procedures for allowing members to select or be assigned to a new PCP including when a PCP is terminated from the Health Plan, or when a PCP change is ordered as part of the resolution to a formal grievance proceeding. In cases where a PCP has been terminated, Contractor must allow members to select another PCP or make a re-assignment within ten (10) calendar days of the termination effective date.

Attachment B: Qualifying Primary Care Services as Identified by CPT Codes

Evaluation/Management CPT Codes: 99201-99205, 99211-99215

Consultation CPT Codes: 99241-99245

Preventive Medicine CPT Codes: 99381-99387, 99391-99397

Attachment K: Reserved

Attachment L: Accountable Entity Road Map Document

Rhode Island Executive Office of Health and Human Services (EOHHS)
Medicaid Program Accountable Entity Roadmap Document



Date of Submission for Center for Medicare and Medicaid Services (CMS)
Review and Approval: Thursday, April 13, 2017

Table of Contents

I.	Roadmap Overview and Purpose	221
II.	Rhode Island’s Vision, Goals and Objectives	222
III.	Our Approach	223
IV.	Progress to Date	228
V.	AE Program Structure	233
VI.	AE Certification Requirements	235
VII.	Alternative Payment Methodologies	239
VIII.	Medicaid Incentive Program (MIIP)	242
IX.	Program Monitoring, Reporting, & Evaluation Plan	252
	Appendix A: Stakeholder Meetings and Feedback	256
	Appendix B: Roadmap Required Components	259

I. Roadmap Overview and Purpose

This Accountable Entity (AE) Roadmap is being submitted by the RI EOHHS, as the single state Medicaid agency in Rhode Island, to CMS for review and approval in accordance with Special Term and Condition (STC) 48 of Rhode Island's Health System Transformation Project (HSTP) Amendment to the state's 1115 Medicaid Demonstration Waiver.

The purpose of this document is to:

- Document the State's vision, goals and objectives under the Waiver Amendment.
- Detail the state's intended path toward achieving the transformation to an accountable, comprehensive, integrated cross-provider health care delivery system for Medicaid enrollees, and detail the intended outcomes of that transformed delivery system.
- Request review and approval by CMS, as is required before the state can begin payments of Medicaid Incentive Funds under the Waiver Amendment

The Accountable Entity "Roadmap" is a requirement of the Special Terms and Conditions (STCs) of RI's Health System Transformation Waiver (STC 48). The State must develop an Accountable Entity Roadmap for the Health System Transformation Project to be submitted to CMS for CMS's 60-day process of review and approval. The State may not claim FFP for Health System Transformation Projects until after CMS has approved the Roadmap. Once approved by CMS, this document will be incorporated as Attachment N of the STCs, and once incorporated may be altered only with CMS approval, and only to the extent consistent with the approved waivers, expenditure authorities and STCs. (Changes to the protocol will apply prospectively, unless otherwise indicated in the protocols.)

The Accountable Entity Roadmap will be a conceptualized living document that will be updated annually to ensure that best practices and lessons that are learned throughout implementation can be leveraged and incorporated into the State's overall vision of delivery system reform. This Roadmap is not a blueprint; but rather an attempt to demonstrate the State's ambitions for delivery systems reform and to outline what the State and its stakeholders consider the payment reforms required for a high quality and a financially sustainable Medicaid delivery system.

This roadmap has been developed with input from participating MCOs, Accountable Entities and stakeholders. A draft roadmap was posted for public input in December 2016. Twenty-four (24) comments were received from a variety of stakeholders representing provider, insurers, and advocates. Thirteen (13) public input sessions were held between January and March 2017 to inform the final roadmap. A full list of public sessions can be found in **Appendix B**.

A detailed list of the required Roadmap elements, and the location of each element in this document,

is provided in **Appendix C**.

II. Rhode Island’s Vision, Goals and Objectives

Rhode Island’s Medicaid program is an essential part of the fabric of Rhode Island’s health care system serving one out of four Rhode Islanders in a given year and closer to thirty percent over a three- year period. The program has achieved national recognition for the quality of services provided, with Medicaid MCOs that are consistently ranked in the top ten in national NCQA rankings for Medicaid MCOs.

However, there are important limitations to our current system of care – recognized here in Rhode Island and nationally:

- It is generally fee based rather than value based,
- It does not generally focus on accountability for health outcomes,
- There is limited emphasis on a Population Health approach, and
- There is an opportunity to better meet the needs of those with complex health needs and exacerbating social determinants.

As such, the current system of care, both in Rhode Island and nationally, focuses predominantly on high quality medical care treatment of individual conditions – as is encouraged and reinforced by our fee for service (FFS) payment model. As a result of this model, there is often siloed and/or fragmented care, with high readmissions and missed opportunities for intervention. Specifically:

- *Within Medical Care:* There is limited focus on transitions, discharges, care coordination, and medication management across and between hospitals, specialists and primary care providers.
- *Between Medical Care and Behavioral Health care:* There is limited effective coordination between medical and behavioral providers, often acting as two distinct systems of care.
- *Complicated by growing needs of an aging population:* This will challenge medical models of care and require broader definitions of care (e.g., dementia, cognitive issues).
- *Between Medical Care and Social Determinants:* There is limited recognition and adaptation of a medical model that recognizes common factors impacting health of Medicaid populations – such as childhood trauma and its long-term impacts, mistrust of the health care system, etc. There is also limited capacity to address broader social needs, which often overshadow and exacerbate medical needs – e.g., housing/housing security, food security, domestic violence/sexual violence.

As a result, although individual providers are often high performing, **no single entity “owns” service integration, and no single entity is accountable for overall outcomes - only specific services.**

Effective interventions must “break through” the financing and delivery system disconnects, to build partnerships across payment systems, delivery systems and medical/social support systems that effectively align financial incentives and more effectively meet the real life needs of individuals and their families.

These issues are particularly problematic when serving the most complex Medicaid populations -- the six percent of Medicaid users with the most complex needs and highest costs that account for almost

two thirds (65%) of Medicaid claims expenditure. Specifically:

- **Populations receiving institutional and residential services**

Nearly half (45%) of claims expenditure on high cost users is on nursing facilities for the

elderly and disabled, and on residential and rehabilitation services for persons with developmental disabilities.

- **Populations with integrated physical and behavioral health care needs**

Forty percent (40%) of claims expenditure on high cost users is for individuals living in the community, most (82%) of whom have multiple co-morbidities, with both physical and mental health or substance abuse needs that require an integrated approach.

The vision, as expressed in the *Reinventing Medicaid* report is for “...a reinvented Medicaid in which our Medicaid managed care organizations (MCOs) contract with Accountable Entities (AEs), integrated provider organizations that will be responsible for the total cost of care and healthcare quality and outcomes of an attributed population.”

The goals are consistent with initiatives taking hold across the country – a movement toward Accountable Care Organizations, including value based payment, new forms of organization, and increased care integration. **Specific goals of this initiative**, developed in alignment with SIM and other ongoing initiatives in our RI environment include:¹⁴

- Transition from fee for service to value based purchasing
- Focus on Total Cost of Care (TCOC)
- Create population based accountability for an attributed population
- Build interdisciplinary care capacity that extends beyond traditional health care providers
- Deploy new forms of organization to create shared incentives across a common enterprise
- Apply emerging data capabilities to refine and enhance care management, pathways, coordination, and timely responsiveness to emergent needs

As a result of this transformation of the Rhode Island Medicaid program (and in partnership with other efforts such as SIM), RI anticipates that **by 2022, Rhode Island will have achieved the following objectives:**

- Improvements in the balance of long term care utilization and expenditures, away from institutional and into community-based care;
- Decreases in readmission rates, preventable hospitalizations and preventable ED visits; and
- Increase in the provision of coordinated primary care and behavioral health services in the same setting.

This document establishes the Roadmap to achieve the vision, goals and objectives described here.

III. Our Approach

As stated above, the Rhode Island Accountable Entity Program is intended to “*break through the financing and delivery system disconnects, to build partnerships across payment systems, delivery systems and medical/social support systems that effectively align financial incentives and more effectively meet the real life needs of individuals and their families.*”

¹⁴ RI's Office of the Health Insurance Commissioner (OHIC) received a SIM (State Innovation Model) grant from CMS to test health care payment and service delivery reform models over the next four years, in a project called Healthy Rhode Island.

The Accountable Entity program shall be developed within, and in partnership with, Rhode Island’s existing managed care model, building on its existing strengths. The AE program will enhance the capacity of MCOs to serve high-risk populations by increasing delivery system integration and improving information exchange/clinical integration across the continuum.

Structurally, the Accountable Entity program includes three core “pillars”:

- (1) EOHHS Certified Accountable Entities and Population Health,
- (2) Progressive Movement toward EOHHS approved Alternative Payment Methodologies,
- (3) Incentive Payments for EOHHS Certified AEs, as depicted below:

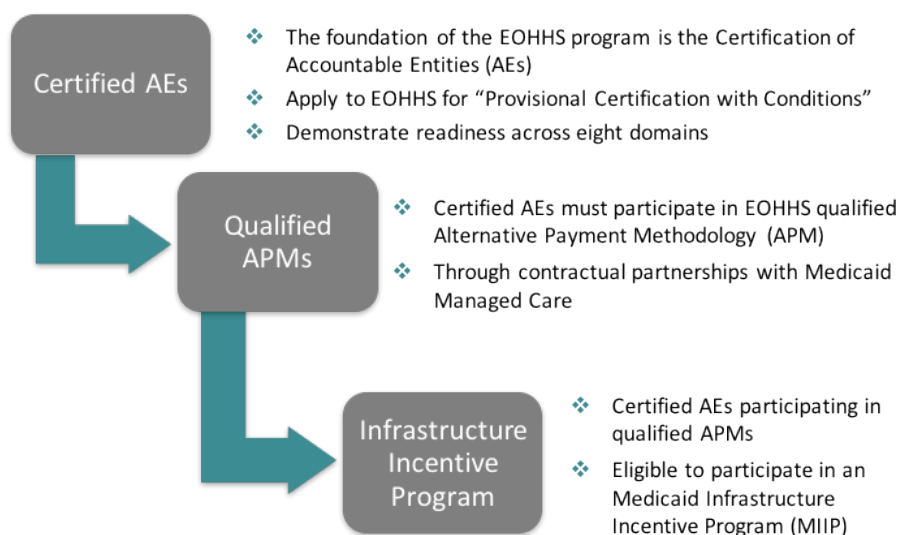

Not all providers are at the same level of readiness for the interdisciplinary integration and transition to alternative payment methodologies envisioned by this program. As such, EOHHS is taking a **multi-pronged strategy**, in order to effectively “meet providers where they are” and enable the necessary system transformation. **EOHHS anticipates at least three specific programs:**

Phase 1: Comprehensive AE Program

EOHHS views the full development of high performing Comprehensive AEs as the core objective of its Health System Transformation Program. The Comprehensive AE Pilot already underway shall be expanded and enhanced for full implementation. The Comprehensive AE represents an interdisciplinary partnership of providers with a strong foundation in primary care and inclusive of other services, most notably behavioral health and social support services. The AE will be accountable for the coordination of care for attributed populations and will be required to adopt a defined population health approach.

Phase 2: Specialized LTSS AE Pilot Program

EOHHS is committed to improving the balance of long term care utilization and expenditures, away from institutional and into community-based care. Encouraging and enabling LTSS

eligible and aging populations to live successfully in the community requires a focused approach. As such, we have defined two interim Specialized AE models: LTSS Pilot AEs and Medicaid Pre-Eligibles. Ultimately, EOHHS anticipates that specialized AEs will become integrated with Comprehensive AEs.

The long- term services and supports system in Rhode Island is fragmented and dominated by specialized providers who are geographically and/or service specific, and may have differing stages of readiness to engage in accountable systems of care. As such, the Specialized LTSS Pilot AE program is intended to encourage the development of critical partnerships across the LTSS spectrum of services to develop and enhance the necessary infrastructure to support a population management approach, as shown below. These specialized LTSS Pilot AEs will participate in alternative payment models that create appropriate financial incentives for participating providers to enable LTSS eligible populations to overcome barriers to live successfully in the community. The ability of an LTSS AE to address persons with behavioral health needs and dementia will be critical.

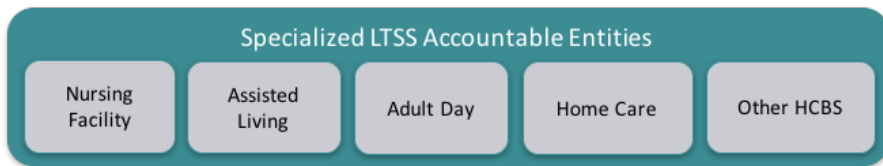

Multiple providers and groups of providers of LTSS services have expressed strong interest in this pilot. However, Rhode Island’s LTSS system of care is fragmented and dominated by specialized providers who are geographically and/or service specific. Significant infrastructure development is required to build the necessary capacity and capabilities for these providers to effectively manage a population under a total cost of care model.

Phase 3: Medicaid Pre-Eligibles Pilot Program

Note that authority for this program shall be requested under the RI Medicaid Waiver renewal, to be submitted in December 2017 and effective January 1, 2019. EOHHS seeks to implement this program once it is approved under the waiver extension.

EOHHS is seeking Medicaid prevention/deferral strategies to enable and encourage aging populations to live successfully in the community. To be effective, EOHHS must work “upstream”, and support people in the community who are not yet Medicaid eligible but are at high risk of becoming so when/if faced with a critical incident or depletion of resources. Effective programs in this arena must “break through” the financing system disconnects shown below to create financial incentives for participating providers.

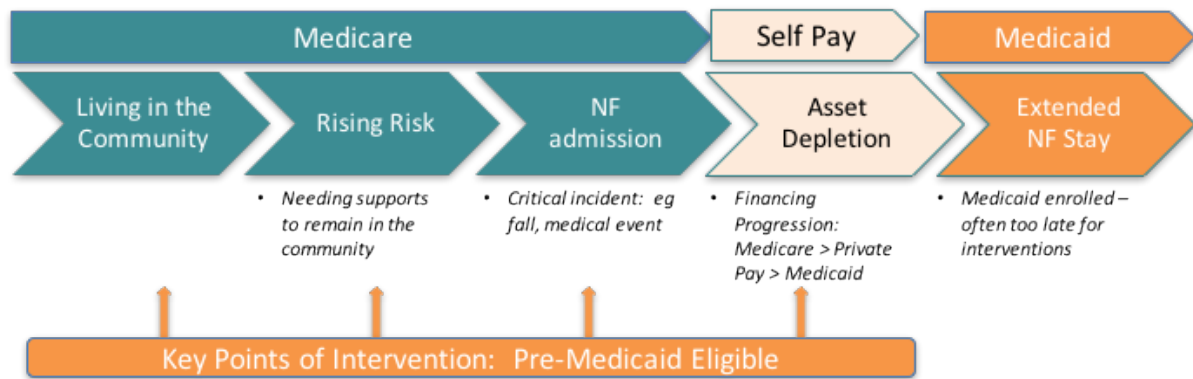

As such, EOHHS will be in the process of developing a pilot program intended to engage high volume Medicare providers in the development and implementation of targeted interventions for Medicaid Pre-eligibles, especially at-risk populations residing in the community. This pilot is still in the design phase – to be implemented subject to approval by CMS under the 1115 Waiver Demonstration.

EOHHS anticipates that additional programs may be added over time, based on learnings from the current programs and pilots.

EOHHS is taking a phased approach to implementation, with a process and timeline that allows for the incorporation of ongoing learnings, as shown below:

AE Type	Primary Target Population	Program Phase	CY 2015	CY 2016	CY 2017	CY 2018	CY 2019	CY 2020	CY 2021	CY 2022
Comprehensive AE	Medicaid only	Program Design and Pilot Certification								
		Pilot Performance Period		***						
		Certification Renewal/ Full Certification								
		Full program performance period								
Specialized LTSS	LTSS Eligibles*	Program Design and Pilot Certification								
		Pilot Performance Period				***				
		Certification Renewal/ Full Certification								
		Full program performance period								
Medicaid Pre-Eligibles subject to CMS approval**	Medicaid LTSS Prevention: Medicare eligibles at risk of becoming duals	Program Design and Pilot Certification								
		Pilot Performance Period					***			
		Certification Renewal/ Full Certification								
		Full program performance period								
*** Initial pilot performance period begins										
* Includes duals and nonduals eligible for LTSS										
** Authority for this program shall be requested under the RI Medicaid Waiver renewal, to be submitted in Dec 2017 and effective 1/1/19.										

Note that the Comprehensive AE program is already underway, as Pilot AEs were certified in the fall of 2015 and APM contracts were in place between MCOs and Pilot AEs in 2016. EOHHS plans to

move the Comprehensive AE program to full certification in CY 2017 with the first full program performance period beginning in CY 2018. The two new pilot programs (Specialized LTSS AE and Medicaid Pre-Eligibles) will follow a similar trajectory, with staged implementation dates and targeted pilot performance periods in CY 2018 and CY2019 respectively.

EOHHS is committed to supporting this system transformation through our Medicaid Incentive Program (MIIP). An estimated \$76.8 Million in Health System Transformation Funds will be allocated to the MIIP, supporting MCOs and AEs in building the capacity and tools required for effective system transformation.¹⁵ These funds must be used to support state defined priorities, in specified allowable expenditure areas, and will be tied to the achievement of AE and MCO specific projects, deliverables and milestones.

Effective implementation of this program will mean that **by 2022 at least one third (33%) of Medicaid eligibles will be attributed to an EOHHS Accountable Entity, participating in an EOHHS approved Alternative Payment Methodology (APM).** This goal will be accomplished in accordance with the following progression:

Percent of Medicaid covered lives attributed to an EOHHS approved APM

Performance Year	Target
DY 10 CY 2018	10%
CY 2019	15%
CY 2020	20%
CY 2021	25%
CY 2022	33%

Beyond this Roadmap, **four core guidance documents will govern this program**, specifying requirements for EOHHS, MCOs and participating AEs:

Core Documents	Targeted CMS Submission	Description
1. AE Application and Certification Standards	Spring 2017	<ul style="list-style-type: none"> • AE certification standards • Applicant evaluation and selection criteria • Submission guidelines
2. APM Guidance	Fall 2017	<ul style="list-style-type: none"> • Required components and specifications for each allowable APM structure • AE Scorecard • Areas of required consistency, flexibility
3. Attribution Guidance	Fall 2017	<ul style="list-style-type: none"> • Required processes for AE attribution, hierarchy

4. Medicaid Incentive Program Guidance	Fall 2017	<ul style="list-style-type: none">• Additional details on funding allocation, required priorities, allowable areas of expenditure, milestones
--	-----------	---

¹⁵ Subject to available funds captured in accordance with CMS approved claiming protocols.

Note that EOHHS is continuously seeking input on these core programmatic guidance documents as follows:

- EOHHS shall hold public input sessions and participant working sessions with key stakeholders and interested public participants to refine each guidance document.
- Draft guidance shall be posted, comments received will be reviewed, and documents will be revised in consideration of public comments before final submission to CMS for approval. For example, this Roadmap, including draft elements of each of these additional core documents, was posted in December 2016 and Stakeholders and participants provided many valuable comments which will be included in the final guidance
- The 1115 Waiver Taskforce provides an additional forum for public input. It is a statutorily defined (RIGL Chapter 42-12.4-9) committee, co-chaired by a senior state official of EOHHS/DHS and a member of the community and including representation from each population receiving Medicaid services. This group meets monthly. Medicaid AE's are a standing agenda item on the 1115 Waiver Task Force, thereby providing opportunity for a brief update on the status of the design and implementation.
- **On-going and ad-hoc Partner Meetings with MCOs and potential AE providers are held to cover emerging topics.**
- EOHHS holds AE Office Hours for stakeholders every other week. These meetings are scheduled through September, 2017; however, they will be continued past September, if needed.

IV. Progress to Date

EOHHS has made significant progress along several aspects of the Accountable Entity strategy. Key actions taken to date include:

1. Comprehensive AE Pilot Program Implementation
2. Specialized AE Pilot Program Development
3. Establishment of funding mechanism for Incentive payments

Key action steps to date in each of these areas are highlighted below.

1. Comprehensive AE Pilot Program Implementation

Rhode Island has already begun moving forward with the creation and support of Accountable Entities (AEs), while simultaneously testing critical program design elements. To approach the task of how to best advance such models in Rhode Island, EOHHS issued an RFI in August 2015 and received 14 responses with many thoughtful comments and recommendations. Based on feedback from the RFI and experience in other states, the state implemented an Accountable Entity Pilot Program as a **fast-track path and an opportunity for early learnings in late fall 2015**. EOHHS then provisionally certified Pilot AEs and issued companion documents specifying attribution rules and total cost of care guidance.

Pilots were certified with the understanding that:

- The state would be proceeding to move past the Pilot phase and, based on experiences and learnings from RI and across the country, would develop more extensive and refined certification standards. Applicants for pilot certification would be expected to comply with those new standards.
- The state would pursue opportunities with the federal government that, if successful, would enable state investments in the further development of AE capabilities.

To date, there have been three rounds of pilot AE applications. Applicants had to demonstrate readiness across three key design domains, including governance, organizational capability, and data/analytic capability. Qualified pilot applicants were “Provisionally Certified with Conditions”, which specified limitations to their contracting authority and confirmed required developmental steps and timelines.

The following six provider-based entities have been designated as Provisionally Certified Pilot AEs, eligible to enter into Total Cost of Care-based shared savings programs with Medicaid MCOs beginning in January 2016:

- Blackstone Valley Community Health Center’s HealthKey Accountable Entity
- Coastal Medical, Inc.
- Community Health Center Accountable Care Organization (CHC ACO)¹⁶
- Integra Community Care Network, LLC
- Providence Community Health Centers, Inc.’s Providence ChoiceCare AE
- Prospect Health Services Rhode Island, Inc. (PHSRI)

These six AEs were certified as “Type 1” AEs, meaning they are certified to contract for all services for a total attributed population. As of July 2016, **more than one third (1/3) of total Medicaid lives were attributed to participating pilot AEs under Total Cost of Care pilot terms, as shown below:**

AE Pilot: Attributed Lives

Type 1 Attributed Lives	United	NHP	Total MCOs
Blackstone Valley (BVCHC)		8,933	8,933
Integra (CNE, SCH & RIPCP)	19,011	20,140	39,151
PHSRI	5,350	5,411	10,761
PCHC Providence ChoiceCare AE		25,037	25,037
CHC ACO+		28,160	28,160
Total Type 1	24,361	87,681	112,042

Sources and Notes: United and NHP attributed lives from Q4 2016 snapshot reports. Coastal was provisionally certified in July 2016 and has not yet contracted with the MCOs.

1.

¹⁶ Community Health Center Accountable Care Organization (CHC ACO) currently includes East Bay Community Action Program (EBCAP), Comprehensive Community Action, Inc. (CCAP), Thundermist Health Center, Tri-Town Community Action Agency, WellOne Primary Medical & Dental Care, and Wood River Health Services.

These AE pilot participants provide three different models of Comprehensive Accountable Care, which will allow significant opportunities for evaluation going forward. There are two hospital based entities, one multispecialty group practice, and three FQHC based models, all of which demonstrate a commitment to primary care infrastructure and an interdisciplinary approach.

2. Specialized AE Pilot Program Development

“Specialized” AEs are generally intended as an interim arrangement to enable providers to form networks that will build the capacity and infrastructure needed to manage specialized populations across providers. Over time, EOHHS intends that these Specialized AEs would partner with a Comprehensive AE.

In conjunction with the Comprehensive AE Pilot Program implemented in late fall, 2015, EOHHS included an opportunity for provisional certification of specialized “Type 2”

Accountable Entities. Specifically, the Specialized Pilot Type 2 AEs was intended to encourage and enhance integrated care for persons with SPMI/SMI (Serious & Persistent Mental Illness/Serious Mental Illness), consistent with EOHHS’ goal of integrating physical and behavioral health services. As such, organizations with attributed SPMI/SMI populations were eligible to become “Type 2” AEs, eligible to participate in a total cost of care based shared savings arrangement with participating Medicaid MCOs.

In practice, the implementation of this type of Specialized AE resulted in the alignment of Specialized AEs with Comprehensive AEs. As such, EOHHS intends to sunset the Type 2 SPMI Specialized Accountable Entity, instead encouraging integration of SPMI populations with comprehensive AEs, as has already occurred in the market. EOHHS remains committed to continued improvements and enhancements in integrated care for persons with SPMI/SMI.

EOHHS is also working closely with stakeholders to develop a Specialized LTSS AE Pilot Program to focus on providers of long term services and supports (LTSS). Activities to support this initiative so far include:

- Establishment of key program goals
- Multiple discussions with key stakeholders and public meetings
- Research and evaluation of similar programs in other states
- Detailed discussions with key stakeholders regarding potential program structure, including attribution methods, APM models and performance metrics

Specialized LTSS-focused AEs are intended to achieve the rebalancing goals of Reinventing Medicaid by effectively enabling and encouraging aging populations to live successfully in the community. This requires creating sufficient financial incentives for current LTSS providers – nursing facilities, home and community based providers -- to work together to change the way care is delivered to our aging population. As such, the Specialized LTSS focused AE program shall:

- Support **focused investments** to build capacity and fill in gaps in infrastructure to more effectively address the needs of vulnerable seniors, supporting their ability to successfully remain in the

community.

- Encourage and invest in the development of **integrated care delivery models**, such that providers build collaborative LTSS focused integrated care delivery systems that include a continuum of care. Ability to address persons with behavioral health needs and dementia will be critical.
- Encourage/require **alternative payment methodologies** that support this integrated system and that align financial incentives both across payors and between the state, MCOs and providers.
- Change financial incentives for Nursing Facilities – encourage them to reduce length of stay, increase quality, and send people home quicker.

EOHHS is also beginning to design a Medicaid Pre-Eligibles Pilot Program. The conceptual design as tested with stakeholders in the draft roadmap in January 2017 was met with strong interest and positive feedback, and initial design discussions have already begun with interested stakeholders. **Over the coming months, EOHHS intends to work** with CMS and local parties to design potential pathways for this innovative approach.

3. Establishment of funding mechanism for Incentive payments

Beginning in late 2015, EOHHS began pursuing Medicaid waiver financing to provide support for AEs by creating a pool of funds primarily focused on assisting in the design, development implementation, and administration of the infrastructure needed to support Accountable Entities. RI submitted an application for such funding in early 2016 as an amendment to RI's current Comprehensive Medicaid 1115 Waiver Demonstration. In October 2016 CMS approved this waiver amendment, for a federal share of \$129.8 million in federal financial participation (FFP) to RI from November 2016 through December 2020.¹⁷

This funding is based on the establishment of an innovative **Health Workforce Partnership** with RI's three public higher education institutions: University of Rhode Island (URI), Rhode Island College (RIC), and the Community College of Rhode Island (CCRI), as illustrated below.

¹⁷ The current Rhode Island 1115 Waiver is a 5-year demonstration, ending in 2018. The STCs include DSHP funding authority through 2018, with a commitment articulated in the cover letter to extend this authority thru 2020 upon waiver renewal for a total funding opportunity for a federal share of \$129 Million in federal financial participation (FFP).

Health System Transformation Project

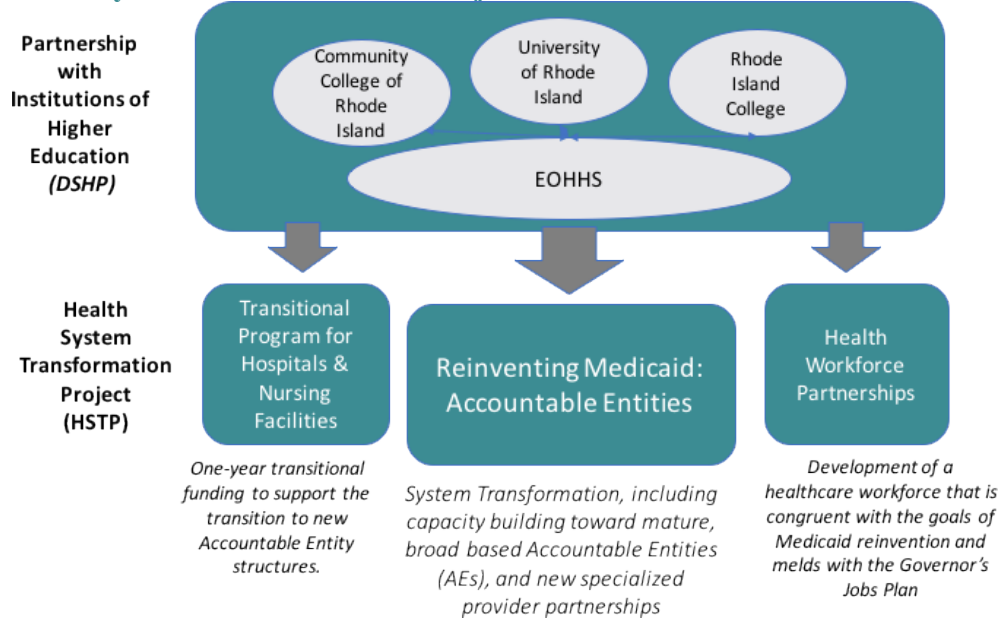

The majority of the financing from this waiver amendment will be provided to AEs as incentive-based infrastructure funding via the state's managed care contracts. Other CMS-funded components include:

- Investments in partnerships with Institutions of Higher Education (IHEs) for statewide health workforce development and technical assistance to AEs
- One-time transitional funding to support hospitals and nursing facilities in the transition to new AE structures¹⁸
- Project management support to ensure effective and timely design, development, implementation, and administration of this program
- Project demonstration pilots and project evaluation funding to support continuous program learning, advancement and refinement
- Other supporting programs, including Consumer Assistance, Wavemaker Fellowship, TB Clinic, RI Child Audiology Center, and Center for Acute Infectious Disease Epidemiology

As mentioned above, the current RI 1115 Waiver expires December 31, 2018. The STCs of the waiver amendment include expenditure authority for this program up to \$79.9 million FFP through the end date of the current waiver.

¹⁸ The STCs limit this program to be one-time only and to not exceed \$20.5 million, paid on or before December 31, 2017.

V. AE Program Structure

EOHHS intends to expand and refine the current Pilot Accountable Entity Program to further support and encourage the development of Accountable Entities. As such, the Accountable Entity Program will include three core “pillars” as shown and described below. Each of these pillars will be articulated through specified arrangements with certified AEs. These three pillars are noted briefly here and described more fully later in this Roadmap.

The vehicle for implementing the AE initiative will be contractual relationships between the AE and Medicaid’s Managed Care partners. EOHHS, with stakeholder input, has established requirements for Accountable Entity certification as well as Managed Care performance requirements for AE contracts. Once an AE is certified by EOHHS, the AE is now eligible to enter a value based Alternate Payment contract (i.e. total cost of care/shared savings and/or risk model) with any of the State’s Medicaid MCOs based on the methodology established by EOHHS (total cost of care model, including quality measures, attribution, and incentive funding distribution) and in conformance with EOHHS contractual requirements as set forth in the contract between EOHHS and the MCO. The MCO and AE contract establishes the specific requirements and milestones associated with the administration of the AE program.

Medicaid MCOs are contractually required to increasingly enter into EOHHS approved value based APM contract arrangements. Certified AEs must enter into value based APM contracts in compliance with EOHHS guidelines in order to participate in member attribution, shared savings arrangements, and to be eligible to receive incentive-based infrastructure payments through the Health System Transformation Program.

Core Pillars of EOHHS Accountable Entity Program

1. EOHHS Certified Accountable Entities and Population Health

The foundation of the EOHHS program is the certification of Accountable Entities (AEs) responsible for the health of a population of members.

2. Progressive Movement toward EOHHS approved Alternative Payment Methodologies

Fundamental to EOHHS’ initiative is progressive movement from volume based to value based payment arrangements and movement from shared savings to increased risk and responsibility. Once an AE is certified, the AE must pursue value-based Alternative Payment Methodologies (APMs) with managed care partners in accordance with EOHHS defined guidance.

3. Incentive Payments for EOHHS Certified AEs

Incentive-based infrastructure funding will be available to state certified AEs who have entered into qualifying APM contractual agreements with managed care partners. As part of these agreements, AEs may earn incentive-based infrastructure funding under state-specified requirements. Note that Certified Specialized LTSS AE pilots may be eligible to participate in the Incentive Program for an initial six months prior to entering into qualifying APM contractual agreements with managed care partners, in order to support the immediate development of business critical partnerships and technical capacities needed to support an effective Alternative Payment Model.

Note that each of these pillars was developed with an effort to balance the following key principles:



- **Evidence Based**, leveraging learnings from our pilot, other Medicaid ACOs and national Medicare/Commercial experience
- **Flexible enough to encourage Innovation**, ACOs, and particularly Medicaid ACOs, are relatively new, and in many developmental areas clear evidence is not available
- **Robust enough to accomplish meaningful change**, and foster organizational commitments and true investments
- **Specific enough to ensure clarity and consistency**, recognizing that consistent guidelines provide clarity to participants

The following sections provide further detail on each of the three pillars.

VI. AE Certification Requirements

During the spring/summer of 2017, EOHHS will be formalizing the Certification Standards for Accountable Entities. Interested parties will then be invited to submit applications for certification and participation in the program. The issuance of AE Certification Standards, as well as the various stages of the application and approval process, will be managed directly by EOHHS. The final certification standards and application requirements will be based on a combination of the following:

- Learnings to date from the existing AE Pilot program
- National/emerging lessons from other states implementing Medicaid ACOs
- EOHHS multi-year participation in a Medicaid ACO Learning Collaborative facilitated by the Center for Health Care Strategies (CHCS) and sponsored by the Commonwealth Foundation
- Lessons learned from the existing Medicare ACO programs
- Alignment with SIM and the ACO standards as developed by the Rhode Island Office of the Health Insurance Commissioner (OHIC)
- Feedback and comments from stakeholders on the draft AE Roadmap, inclusive of Certification Standards, as posted in December 2016
- Discussion with stakeholders on features and details of AE Roadmap, inclusive of Certification Standards at specific meetings
- Feedback and comments from stakeholders gathered in public meetings/discussions during the beginning of 2017

EOHHS recognizes that potential applicants may have differing stages of readiness. The HSTP

Program is intended as a catalyst for health system change, to induce these emerging organizations to develop new capacities and capabilities toward a new system of care that cares for the whole person and is accountable for both the outcome and cost of care.

As such, AEs will be annually certified, and EOHHS anticipates that most will be **“Provisionally Certified with Conditions” initially**. A provisionally certified entity means that the AE may not be fully compliant with all the organizational capabilities set forth in the certification requirements at the point of application but the AE has a strong application and a plan and commitment to further develop capabilities in key areas. **The outstanding need area or “conditions” shall highlight the gaps in AE capacities and capabilities that will be funded through the Medicaid Incentive Program.** These identified gaps will need to be addressed in accordance with an agreed upon project plan and timeline in order for the AE to continue to be eligible for Medicaid Incentive funds. Eventually, AEs who have demonstrated that all of the domain requirements were fully met will be designated as “Fully Certified”. “Full” certification is not required to be eligible for Medicaid Incentive funds.

EOHHS intends to certify three types of AEs:

- 1. Comprehensive AEs**
- 2. Specialized LTSS Pilot AEs**
- 3. Specialized Medicaid Pre-Eligibles Pilot AEs**

Note that these AEs will serve distinct populations. As such, entities may apply to participate in one or more programs, as long as readiness can be appropriately and specifically demonstrated.

1. Comprehensive AE Certification Standards

EOHHS has identified the critical domains considered instrumental to the success of Comprehensive AEs in meeting the needs of the Medicaid population through system transformation. Note that these requirements do not specify a particular organizational structure. EOHHS values multiple models of AE and encourages entities with different structures to apply (under the current pilot there are FQHC based, hospital based and primary care based Pilot AEs).

AE Applicants must meet minimum requirements in order to be considered for certification.

Preliminary minimum requirements include:

- Minimum attributed lives
- Minimum Medicaid share of lives
- Demonstrated ability to collect, share, and report data
- Demonstrated level of behavioral health integration with primary care, with an established behavioral health provider organization
- Demonstrated affiliation or working arrangement with an SUD treatment provider
- Demonstrated affiliation or working arrangement with community based organizations to address broader social contexts impacting health, outcomes

Final requirements for qualified applicants shall be included in the AE application.

Qualified AE applicants will then be required to demonstrate their specific capacity to serve the

requested populations by meeting requirements across the following domains. Preliminary detailed requirements for each of these domains are included in **Appendix A**.

- **Domain 1: Breadth and Characteristics of Participating Providers**
Interdisciplinary with demonstrated ability to serve a broad continuum of needs including social determinants for attributed populations. Must include a defined affiliation or working arrangement with community based organizations to address broader social contexts impacting health, outcomes.
- **Domain 2: Corporate Structure and Governance**
An adequate and appropriate governance structure to accomplish the program goals
- **Domain 3: Leadership and Management**
A leadership structure, with commitment of senior leaders, backed by the required resources to implement and support a single, unified vision
- **Domain 4: IT Infrastructure: Data Analytic Capacity & Deployment**
A core functional IT capacity to receive, collect, integrate, and utilize information
- **Domain 5: Commitment to Population Health and System Transformation**
A concerted program built on population health principles and systematically focused on the health of the entire attributed population. A systematic population health model that works to improve the health status of the entire attributed population while systematically segmenting subpopulation risk groups with complex needs in order to implement focused strategies to improve their health status.
- **Domain 6: Integrated Care Management**
A comprehensive integrated care management program, including systematic processes and specialized expertise to identify and target populations. An organizational approach and strategy to integrate person-centered medical, behavioral, and social services for individuals at risk for poor outcomes and avoidable high costs.
- **Domain 7: Member Engagement & Access**
Capacity for effective member engagement, including strategies to maximize outreach, engagement, and communication with members in a culturally competent manner
- **Domain 8: Quality Management**
Ability to internally report on quality and cost metrics; to use those metrics to monitor performance, emerging trends, and quality of care issues; and to use results to improve care

It is EOHHS' expectation is that the AE shall be structured and organized to provide care for all populations, including adults and children. However, EOHHS recognizes that the necessary skills and capacities of an AE will vary considerably across populations. Specifically,

- **Children**, including children with special health care needs (CSHCN) and children with high, rising and low risk
- **Adults**, including adults with complex medical needs, co-occurring Behavioral Health/Medical, Homelessness, Substance Use Disorders, Other Disabilities, Intellectual and Developmental

Disabilities.

As such, AE Certification may be specific to an approved population – Children, Adults – with attribution limited to the approved population. AE applicants will need to demonstrate the ability to meet the broad range of needs present in each identified population. Note that in some instances these capacities may be demonstrated by the AE itself, or through its relationship with participating MCOs.

To ensure that incentives are meaningfully and adequately sized, this will be a **competitive program**, with stricter requirements for certification beginning in year two.

Preliminary evaluation and selection criteria are as follows:

- **Demonstrated commitment to EOHHS priorities and Medicaid populations**
Demonstrated capabilities and capacities to serve the unique needs of the Medicaid population, and to address the goals and priorities described in Section 2.
- **Evidence of Readiness (Domains 1-3)**
Specific evidence of strong interdisciplinary network capacity, and an effective governance model and leadership team.
- **Data & Analytic Capacity (Domain 4)**
Demonstrated capacity to collect, integrate and utilize data to support decision-making.
- **System Transformation (Domains 5-8)**
Demonstrated commitment to, and capacity for, population health and system transformation, including a comprehensive, integrated and interdisciplinary care management program, effective member engagement strategies and a strong quality management program.

Final evaluation and selection criteria shall be included in the AE application.

2. Specialized AE Certification Standards: LTSS Pilot Certified AE

The objective of an LTSS Pilot AE will be to build integrated systems of care inclusive of a continuum of services for people, as appropriate, to be able to safely and successfully reside in a community setting. Eligible entities must demonstrate readiness across the same domains as listed above for Comprehensive AEs, with specific requirements within each domain that have been tailored to the specific needs of the LTSS eligible population and the current capacities of the LTSS provider community:

- Domain 1: Breadth and Characteristics of Participating Providers
- Domain 2: Organizational Structure and Governance
- Domain 3: Leadership and Management
- Domain 4: IT Infrastructure – Data Analytic Capacity and Deployment
- Domain 5: Commitment to Population Health and System Transformation
- Domain 6: Integrated Care Management
- Domain 7: Member Engagement and Access
- Domain 8: Quality Management

Note that the Pilot LTSS AE certification standards are intended as a starting point to engage individual providers in the challenging tasks of partnership development. EOHHS anticipates there may be multiple pilot LTSS AEs with different combinations of participating providers and different governance and care management models. Similar to the Comprehensive AE program, EOHHS intends to allow for multiple models under the pilot and will leverage learnings from the pilot to establish more rigorous standards for full implementation.

To ensure that incentives are meaningfully and adequately sized, this will be a **competitive pilot program**, with a limited number of selected participants, subject to available funding.

3. Specialized AE Certification Standards: Medicaid Pre-Eligibles Pilot Certified AEs

Certified Comprehensive AEs may also be eligible to participate in the Medicaid Pre-Eligibles Pilot program if they meet EOHHS specified criteria, to be developed in the coming months.

Comprehensive AEs who are already working with Medicare populations (either through Medicare Advantage or Medicare ACO arrangements) are likely to provide the foundation for such a program.

VII. Alternative Payment Methodologies

Fundamental to EOHHS' initiative is progressive movement to EOHHS-approved Alternative Payment Methodologies (APMs), incorporating clear migration from volume based to value based payment arrangements and movement from shared savings to increased risk and responsibility.

The AE initiative will be implemented through Managed Care. AEs must enter into Managed Care contracts in order to participate in member attribution and shared savings within TCOC arrangements. These AEs will also be eligible to receive incentive payments from their Managed Care partner through the Health System Transformation Program. Correspondingly, MCOs must enter into qualified APM contracts (consistent with EOHHS defined APM guidance) with Certified AEs under the terms of their contracts with EOHHS.

As the primary contractor with EOHHS, the MCOs will retain accountability for ensuring compliance with all contractual requirements and related Federal managed care regulations. It is anticipated that successful development of an AE will include a defined yet dynamic distribution of responsibilities between the MCO and the AE, and that these will be identified in the written agreement between the parties. The distribution of roles and responsibilities may vary among AEs and MCOs to achieve the most effective combination. Performance of certain functions can be delegated to a subcontracting AE, but delegation will be with the expressed obligation to abide by managed care regulations and must be reviewed and approved by the State.

EOHHS is committed to maintaining member choice within the AE program structure. Members must have access to the right care, at the right time, and in the right setting. AE provider relationships may not impact member choice and/or the member's ability to access providers contracted or affiliated with the MCO. While AE based network limits, restrictions and fees are prohibited, MCOs and AEs may encourage utilization of preferred networks provided that rewards or positive financial incentives used are nominal and specifically linked with health-promoting plans of care. All incentives and methods of encouragement of preferred networks must be consistent with CMS requirements for Medicaid.¹⁹

EOHHS is also committed to ensuring that the proposed AE will not limit Medicaid beneficiary access to providers on the basis of AE attribution. It is not the intent of the accountable entity program to create new siloes of care within each system. In particular, AE affiliated hospitals and/or specialists may not in any way limit access to only AE participating providers.

Qualified APM contracts shall be in accordance with EOHHS defined APM guidance. This guidance shall be developed:

- leveraging learnings from the current pilot program guidance documents as implemented in 2016,

¹⁹ Next Generation ACO summary on CMS website: <https://innovation.cms.gov/initiatives/Next-Generation-ACO-Model/index.html>. Next Generation ACO RFA, which includes section on beneficiary coordinated care rewards: <https://innovation.cms.gov/Files/x/nextgenacorfa.pdf>

- in alignment with Federal MACRA rules,
- in alignment with Rhode Island commercial requirements as established by the Office of the Health Insurance Commissioner, and,
- considering public and stakeholder input.

Note that the allowable APMs do NOT require a change to the underlying structure of payment between the MCOs and the AEs. Payment models that maintain the existing fee-for-service structure with a link to a set of quality indicators at risk, including a total cost of care overlay (thereby creating an opportunity for shared savings and risk between payors and providers) would qualify as an APM.

Each of the three AE Programs will specify qualifying APMs that will be based on a specified population of attributed lives, as defined in the table below. Within these respective populations, attribution to an AE shall be implemented in a consistent manner by all participating MCOs based upon EOHHS defined guidance, to be developed with input from stakeholders this spring and submitted for approval by CMS.

AE Attributable Populations

Program	Attributable Populations
1. Comprehensive AEs	Medicaid-only eligible
2. Specialized LTSS AEs	LTSS eligible, including duals and nonduals
3. Specialized Medicaid Pre-Eligibles AEs	Medicare-only eligible

The specific terms of the savings and risk transfer to the AE are at the discretion of the contracting parties. EOHHS does not intend to stipulate the terms of these arrangements but expects they will operate within the bounds of EOHHS defined APM Guidance. In addition, EOHHS does reserve the right to review and approve such arrangements.^{20, 21}

Additional program specific APM requirements are as follows:

Comprehensive AE Alternative Payment Methodology: Total Cost of Care

Managed Care Contracts with Comprehensive Accountable Entities must be based on total cost of care (TCOC) to be defined in forthcoming APM guidance from the EOHHS. These TCOC arrangements shall supersede and be exclusive of any other TCOC-related shared savings arrangements with an AE or any of its constituent providers. TCOC contracting between MCOs and AEs must meet guidelines set forth by EOHHS. MCOs are responsible to EOHHS for compliance in this matter. The MCOs will report to EOHHS outcomes on quality and financial performance by AEs on a schedule set forth in the Managed Care contract.

²⁰ In addition to this EOHHS requirement, note that in certain circumstances transparency in such arrangements is specifically required in CFR42 §438.6.

²¹ CMS has issued guidance for shared savings programs for both Medicaid and for Medicare Shared Savings Programs. See <https://www.medicaid.gov/federal-policy-guidance/federal-policy-guidance.html> and <https://www.cms.gov/Medicare/Medicare-Fee-for-ServicePayment/sharedsavingsprogram>

Qualified total cost of care (TCOC) contracts must incorporate the EOHHS Quality Scorecard.

A comprehensive quality score factor, based on the *Quality Scorecard*, must be applied to any shared savings and/or risk arrangements when calculating the total cost of care. A draft version of this *Quality Scorecard* has been posted for public comment. The final *Quality Scorecard* will be modified, based on stakeholder input, and will align with the quality measures for Accountable Care Organizations (ACOs), which were endorsed by RI SIM. In addition to the required core measures, each MCO and AE may also include a limited number of additional measures from the SIM menu set, Medicaid Adult and/or Child Core Set. The quality calculation construct must be based upon a quality multiplier with a minimum threshold of allocated shared savings.

Qualified TCOC-based contractual arrangements must also demonstrate a progression of risk to include meaningful downside shared risk or full risk. By the end of the anticipated five-year waiver period in October 2021, infrastructure funding will be phased out. AEs will be sustained going forward based on their successful performance and associated financial rewards in accordance with their contract with MCOs.

2. Specialized LTSS Pilot AE: LTSS Bundle

Participating AEs will be responsible for the total cost of care. However, for dual eligible populations Medicare is primary for many services, with different arrangements depending on the program structure. As such, this interim APM arrangement will project the total cost of care for services included within the identified “bundle” of Long Term Services and Supports for the attributed population. This calculation will provide the basis for comparing actual financial experience with the projected financial experience.

The LTSS APM will also include a performance bonus for Pilot LTSS AE performance across a set of agreed upon dimensions. Given that EOHHS anticipates significant challenges in both capturing key data elements and measuring performance across populations, EOHHS would likely begin with a pay for reporting period for some components.

3. Specialized Medicaid Pre-Eligibles Pilot AEs

EOHHS sees an important opportunity in creating a targeted program to address Medicaid pre-eligibles. Previous studies of Medicaid migration patterns for long term care recipients here in Rhode Island have shown that much of the extended stay nursing home population is already in a nursing home when becoming eligible for Medicaid, likely having entered a nursing home and then spent down their assets until they became Medicaid eligible. This suggests that strategies to “rebalance,” away from expensive nursing home settings and toward more cost-effective community based care would benefit from a multi-payer approach, as these high risk individuals must be identified well before they spend down assets and become Medicaid eligible – before they enter a nursing home.

As this program is not slated to begin during this DY approval period, EOHHS intends to work with interested entities in the coming months to develop a reporting and data sharing arrangement that effectively enables combined Medicare and Medicaid population reporting and tracking for populations transitioning from Medicare to Medicaid.

VIII. Medicaid Incentive Program (MIIP)

Beginning in late 2015, EOHHS began pursuing Medicaid waiver financing to provide support for AEs by creating a pool of funds primarily focused on assisting in the design, development and implementation of the infrastructure needed to support Accountable Entities.

CMS has approved up to \$129.8 Million in HSTP program funds²². An estimated \$76.8 M shall be allocated to the AE Program, subject to available funds captured in accordance with CMS approved claiming protocols, as shown below. Under the terms of Rhode Island’s agreement with the federal government, this is not a grant program. AEs must earn payments by meeting metrics defined by EOHHS and its managed care partners and approved by CMS to secure full funding.

	SFY 17	SFY 18	SFY 19	SFY 20	SFY 21	Total
Accountable Entity Program	\$0.0	\$10.0	\$29.4	\$23.9	\$13.5	\$76.8

An AE Program Advisory Committee shall be established by EOHHS. This committee shall be chaired by EOHHS, with a community Co-Chair and shall include representation from participating MCOs, AEs, and community stakeholders and shall:

- Support the development of AE infrastructure priorities,
- Help target Medicaid Incentive Program funds to specific priorities that maximize impact
- Review specific uses of funds by each AE and MCO, such that individual AE Project plans are designed and implemented to maximum effect
- Monitor ongoing MCO/AE program performance
- Support effective program evaluation and integrated learnings

Detailed guidance for this program shall be set forth by EOHHS, with assistance from the AE Program Advisory Committee, in the final HSTP Guidelines for Health System Transformation Project Plans. Draft guidance shall be posted, comments received will be reviewed, and documents will be revised in consideration of public comments before final submission to CMS for approval.

A. Program Structure

The Medicaid Incentive Program (MIIP) shall consist of three core programs: (1) Comprehensive AE Program; (2) Specialized LTSS AE Pilot Program; and (3) Specialized Pre-eligibles AE Pilot Program. EOHHS shall allocate available HSTP funds to these three programs as follows, subject to available funds and EOHHS identification of priority areas of focus and assessment of readiness. This allocation shall be revisited annually.

AE Programs	Share of Available AE Funds	
	Program Year 1	Full Program
Comprehensive AE Program	60-70%	60% - 70%

²² The current Rhode Island 1115 Waiver is a 5-year demonstration, ending in 2018. The STCs include DSHP funding authority through 2018, with a commitment articulated in the cover letter to extend this authority thru 2020 upon waiver renewal for a DSHP funding opportunity for a federal share of \$129 Million in federal financial participation (FFP).

Specialized LTSS Pilot AE Program	30-40%	25% - 35%
Specialized Pre-eligibles Pilot AE Program		5%-15%*

*Authority for this program is dependent upon CMS approval under the RI Medicaid 1115 waiver extension, to be submitted to CMS in December 2017, effective January 1, 2019.

For each MCO the MIIP shall include three dimensions:

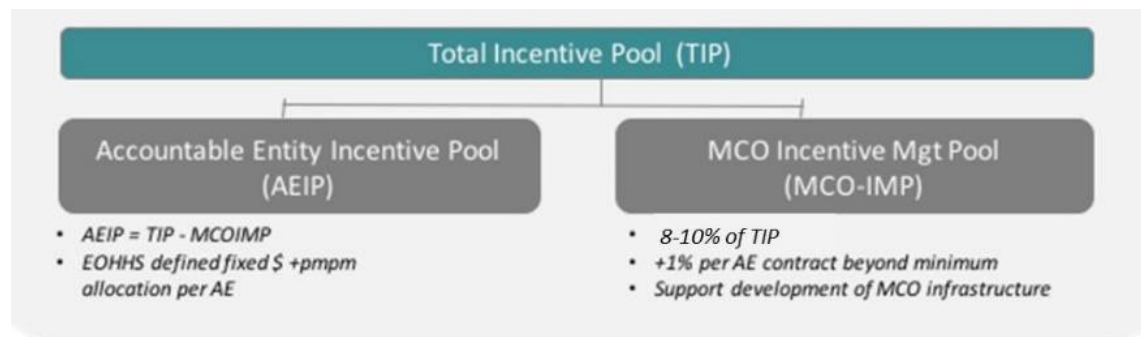

3. Maximum Total Incentive Pool (TIP) for MCOs

The maximum TIP for each MCO shall be determined by EOHHS with consideration to the MCO share of AE attributed lives in accordance with EOHHS defined attribution guidelines and associated reports.

4. MCO Incentive Program Management Pool (MCO-IMP)

Assuming satisfactory MCO performance, the MCO Incentive Program Management Pool shall minimally be eight percent (8%) of the Total Incentive Pool. To the degree that the MCO has more than the minimally required number of contracts with AEs, to be identified in a contract amendment, the MCO-IMP shall be increased by one percent for each AE contract to a maximum of ten percent. These funds are intended for use toward advancing program success, including program administration and oversight, assisting with the development of the necessary infrastructure to support a new business model, and establishing shared responsibilities, information requirements and reporting between EOHHS, the MCO and the Accountable Entities.

5. Accountable Entity Incentive Pool (AEIP)

The Accountable Entity Incentive Pool shall equal the Total Incentive Pool minus the MCO Incentive Program Management Pool ($AEIP = TIP - MCO-IMP$). This pool shall be divided into

the three distinct programs as specified above. In developing contracts with AEs, MCOs shall propose AE Infrastructure Payment Criteria and Methodology for EOHHS review and approval that are consistent with EOHHS defined guidance. This shall determine the total annual amount and schedule of incentive payments each participating AE may be eligible to receive from the Accountable Entity Incentive Pool.

3a. Accountable Entity Specific Incentive Pools

Certified AEs in qualified Alternative Payment Methodology (APM) contracts consistent with EOHHS guidance must be eligible for the Medicaid Incentive Program. Each MCO must create an AE Incentive Pool for each Certified AE to establish the total incentive dollars that may be earned by each AE during the period. The Pool calculation shall include a base amount plus a PMPM component based on attributed lives at the start of each contract year in accordance with EOHHS defined guidance. An example of an AE Incentive Pool calculation for a sample AE is shown below – please note the numbers shown here are illustrative only.

AE #1 Incentive pool Year 1: Illustrative Example Calculation

AE 1 has 15,000 attributed lives, 10,000 are with MCO 1, and 5,000 with MCO 2

Payments from each MCO are for distinct attributed populations and therefore not duplicative.

	MCO 1	MCO 2	Total	Illustrative Example Assumptions	
Attributed lives	10,000	5,000	15,000	\$200,000	base per MCO
Base Amount	\$200,000	\$200,000	\$400,000	\$ 1.50	pmpm
pmpm	\$ 180,000	\$ 90,000	\$270,000		
AE 1 Incentive Pool	\$380,000	\$290,000	\$670,000		

3b. Performance Based Incentive Payments

AEs must develop individual Health System Transformation project plans that identify clear project objectives and specify the activities and timelines for achieving the proposed objectives. Actual AEIP incentive payment amounts to AEs will be based on demonstrated AE performance. Incentive payments actually earned by the AE may be less than the amount they are potentially eligible to earn. MCOs shall not be entitled to any portion of funds from the Accountable Entity Incentive Pool that are not earned by the AE.

Reconciliation

In advance of the MCOs payments to AEs, the MCO shall receive payment from EOHHS in the amount and schedule agreed upon with EOHHS. Any Incentive Program funds that are not earned by EOHHS Certified AEs as planned during a given contract year shall be tracked and retained by the MCO exclusively for future Accountable Entity Incentive Pool uses during the following contract year. Any funds not earned during the following contract year shall be returned to EOHHS within thirty days of such request by EOHHS. An AE’s failure to fully meet a performance metric within the time frame specified will result in forfeiture of the associated incentive payment (i.e., no payment for partial fulfillment). An AE that fails to meet a performance metric in a timely fashion can earn the incentive payment at a later point in time (not to exceed one year after the original performance

deadline) by fully achieving the original metric in combination with on-time performance on the next metric in the performance sequence, in accordance with the requirements for Material Modifications described in Section VIII.C.3 of this document.

B. Program Spending Guidance

Incentive Program funds are designed to be used by AEs to prepare project plans and to build the capacity and tools required for effective system transformation. Allowable expenditures must align with EOHHS program priority areas and shall be distributed by the MCOs to the AEs in designated performance areas.



Allowable Areas of Expenditure

Allowable uses of funds include the following three core areas and eight domains. Costs must be reasonable for services rendered.

Domains	Allowable Uses of Funds	Allowable Expenditure Mix		
		Yr 1	Yr 2-3	Yr 4
A. Readiness		<50%	<25%	<10%
6. Breadth and Characteristics of Participating Providers	<ul style="list-style-type: none"> Building provider base, population specific provider capacity, interdisciplinary partnerships, developing a defined affiliation with community based organizations (CBOs) Developing full continuum of services, Integrated PH/BH, Social determinants 			
7. Corporate Structure and Governance	<ul style="list-style-type: none"> Establishing a distinct corporation, with interdisciplinary partners Joined in a common enterprise 			
8. Leadership and Management	<ul style="list-style-type: none"> Establishing an initial management structure/staffing profile Developing ability to manage care under Total Cost of Care (TCOC) arrangement, with increased risk and responsibility 			
B. IT Infrastructure		30%	30%	30%

9. Data Analytic Capacity and Deployment	<ul style="list-style-type: none"> • Building core infrastructure: EHR capacity, patient registries, Current Care • Provider/care managers’ access to information: Lookup capability, medication lists, shared messaging, referral management, alerts • Patient portal • Analytics for population segmentation, risk stratification, predictive modeling • Integrating analytic work with clinical care: Clinical decision support tools, early warning systems, dashboard, alerts • Staff development and training – individual/team drill downs re: conformance with accepted standards of care, deviations from best practice
--	--

C. System Transformation		20%	45%	70%
10. Commitment to Population Health and System Transformation	<ul style="list-style-type: none"> • Developing an integrated strategic plan for population health that is population based, data driven, evidence based, client centered, recognizes Social Determinants of Health, team based, integrates BH, IDs risk factors • Healthcare workforce planning and programming 			
9. Integrated Care Management	<ul style="list-style-type: none"> • Systematic process to ID patients for care management • Defined Coordinated Care Team, with specialized expertise and staff for distinct subpopulations • Individualized person centered care plan for high risk members 			
10. Member Engagement and Access	<ul style="list-style-type: none"> • Defined strategies to maximize effective member contact and engagement • Use of new technologies for member engagement, health status monitoring and health promotion 			
11. Quality Management	<ul style="list-style-type: none"> • Defined quality assessment & improvement plan, overseen by quality committee 			

EOHHS anticipates that spending may be heavily weighted toward the Readiness Core Area (domains 1-3) in year one, as AEs build the capacity and tools required for effective system transformation. However, over time the allowable areas of expenditure will be required to shift toward system transformation (domains 5-8). A preliminary allowable mix of expenditures is shown above.

Program Priorities

Each MCO’s AE Incentive Pool budget and actual spending must align with the priorities of EOHHS as developed with the support of the Advisory Committee and shown below. Note: This is a draft set of priorities – a final set of priorities shall be reviewed and confirmed by the Advisory Committee, and specified in the final APM guidance document.

Program	Priorities
Comprehensive AEs	<ul style="list-style-type: none"> ● Planning and core infrastructure development ● Medical enhancements: enhanced systems of care, workforce development <ul style="list-style-type: none"> ○ For children ○ For Adults ● Integration and innovation in behavioral health care <ul style="list-style-type: none"> ○ For children
	<ul style="list-style-type: none"> ○ For Adults ● Integration and innovation in SUD treatment ● Integration and intervention in social determinants, including cross system impacts
Specialized Pilot LTSS AEs	<ul style="list-style-type: none"> ● Building partnerships, including governance, leadership and financial arrangements, between LTSS providers. ● Developing programs and care coordination processes towards effective and timely care transitions and reduced institutional/ED utilization ● Repurposing skilled nursing capacity for acute psychiatric transitions and/or adult day capacity ● Home and Community based Behavioral Health capacity development for behavioral health specialized adult day care, home care, and alternative living arrangements.

Specialized Medicaid Pre-Eligibles AEs	<ul style="list-style-type: none"> • Developing processes, tools and protocols for identification of at risk Medicaid pre-eligible populations • Developing effective and evidence based interventions to support community based care for these populations. EOHHS is committed to working with these entities to define and develop opportunities (mechanisms to pay for) for the specific services needed for identified Medicaid pre-eligible populations that may not currently be Medicare covered services – e.g., home based primary care, palliative care, community health workers, etc. <i>Note that authority for this program shall be requested under the RI Medicaid Waiver renewal, to be submitted in March of 2018 and effective January 1, 2019. EOHHS seeks to implement this program once it is approved under the waiver extension.</i>
---	---

Performance Areas

AEs must develop AE Specific Health System Transformation Project Plans. These plans shall specify the performance that would qualify an AE to earn incentive payments. Earned funds shall be distributed by the MCO to the AE in accordance with the distribution by performance area defined in the AE specific Health System Transformation Plan, consistent with the requirements defined below:

Performance Area	Minimum Milestones	Year 1	Year 2	Year 3	Year 4
Planning and Design	<ul style="list-style-type: none"> • Execution of Contract, Initial Workplan & budget for developing an AE Project Plan, including completed EOHHS Budget Template • Detailed AE Gap Analysis, with specified impacts by domain and 	70%	15%	0%	0%
	population				

Developmental Milestones	<ul style="list-style-type: none"> • Detailed Health System Transformation Project Plan, including proposed Infrastructure Development Budget by Project, Domain and population, in accordance with state specified template • Quarterly Progress Report in accordance with state defined template • Quarterly financial report, in accordance with state defined template, including documented evidence of expenditures • Developmental milestones MCO/AE Defined (at least 3 unique developmental milestones per year) 	30%	85%	75%	50%
Value based purchasing metrics	<ul style="list-style-type: none"> • Demonstrated APM Progression • Marginal Risk Requirements • Minimum required share of marginal risk for which the AE is liable, in accordance with EOHHS define APM guidelines 	0%	0%	20%	30%
System Performance Metrics	<ul style="list-style-type: none"> • Preventable Admissions • Readmissions • Avoidable ED Use • MCO/AE Specific Performance Targets (up to 3) 	0%	0%	5%	10%
Final Deliverable		0%	0%	0%	10%

The early milestones are intended to allow AEs to develop the foundational tools and human resources that will enable AEs to build core competencies and capacity. In accordance with EOHHS' agreement with CMS, participating AEs must fully meet milestones established in the AE specific health system transformation plan prior to payment. EOHHS recognizes the financial constraints of

many participating AEs, and that timely payment for the achievement of early milestones will be critical to program success.

These AE-specific HSTP project plans may only be modified with state approval, in accordance with the Material Modification requirements outlined in section C.3 below, and further specified in the EOHHS Guidelines. EOHHS may require that a plan be modified if it becomes evident that the previous targeting/estimation is no longer appropriate or that targets were greatly exceeded or underachieved.

C. Implementation and Oversight

As described above, the Medicaid Incentive Program (MIIP) includes EOHHS **program priority areas, allowable areas of expenditure, and AE specific performance areas** that qualify an AE to earn incentive payments. With the assistance of the Advisory Committee EOHHS will develop “EOHHS Guidelines for Health System Transformation Project Plans” that will further specify each of these program elements. This guidance will define specific implementation requirements that must be adhered to by AEs and MCOs to ensure that incentive programs are designed and implemented to maximum effect.

Four key elements of these implementation requirements to be further stipulated in the guidelines are as follows:

1. Specifications Regarding Allowable HSTP Project Plans

Specifications shall delineate additional details regarding:

- Core Goals
- Allowable Priority areas
- Allowable Areas of Expenditure
- Required Performance Areas
- Characteristics of approvable project plans:
 - Approvable project plans must demonstrate how the project will advance the core goals and identify clear objectives and steps for achieving the goals.
 - Approvable project plans must set timelines and deadlines for the meeting of metrics associated with the projects and activities undertaken to ensure timely performance.

2. MCO Review Committee Guidelines for Evaluation

The MCO shall convene a review committee to evaluate each proposal. EOHHS shall have a designee that participates on the MCO submission evaluation committee to ensure the state’s engagement in the process to evaluate the project plan and associated recommendations for approval or disapproval. The MCO Review Committee, in accordance with EOHHS guidelines, shall determine whether:

- **Project as submitted is eligible for award**
Eligible projects will include a project plan that clearly address EOHHS priority areas and clearly includes the types of activities targeted for funds.
- **Project merits Incentive Funding**

Projects must show appropriateness for submission for this program by including the following:

- Clear statement of understanding regarding the intent of incentive dollars
- Rationale for this incentive opportunity, including a clear description of objective for the project and how achieving that objective will promote health system transformation for that AE
- Confirmation that project does not supplant funding from any other source and is non-duplicative of submission that may be made to another MCO
- High quality proposal that includes a gap analysis, explains how the workplan and budget addresses these gaps, and describes the AE's current strengths and weaknesses in this area
- Clear interim and final project milestones and projected impacts, as well as criteria for recognizing achievement of these milestones and quantifying these impacts
- **Incentive Funding request is reasonable and appropriate**
The funding request must be reasonable for the project identified, with funds clearly dedicated to this project. The level and apportionment of the incentive funding request must be commensurate with value and level of effort required.

3. **Material Modification of HSTP Project Plans**

EOHHS guidelines shall delineate additional details regarding material modification requests, to include:

- **Definition**
A Material Modification includes any change to the metrics, deadlines or funds associated with an HSTP Project Plan. Failure to meet performance metrics shall be considered a material modification.
- **Material Modification Request Submission**
An official request must be submitted in writing by the AE to the MCO, including the following:
 - A brief description of the requested change
 - A clear statement of purpose, or justification for the modification
 - A brief statement of the anticipated impact the change will have on the project plan, timeline and goals
 - A listing of any proposed changes in specific metrics or deadlines
- **Review Process and Criteria**
Any material modification to the HSTP Project Plans must be reviewed and approved by the MCO Review Committee. Material modifications that either delay the project by more than 3 months or impact more than 15% of HSTP funding must also be approved by the AE Advisory Committee. Material modification requests must be reasonable for the project identified, with clear revisions to the project milestones, metrics and timelines commensurate with the scope of the modification. In instances where an AE fails to meet (or anticipates that it will not meet) a performance metric, fully achieving the original metric (within one year of the original performance deadline) in combination with on-time performance on the next metric in the performance sequence shall qualify as an acceptable modification.

4. Required Structure for Implementation

The Incentive Funding Request must be awarded to the AE via a Contract Amendment between the MCO and the AE. The Contract Amendment shall:

- Be subject to EOHHS review and approval
- Incorporate the central elements of the approved AE submission, including:
 - Stipulation of program objective
 - Scope of activity to achieve
 - Performance schedule
 - Payment terms – basis for earning incentive payment(s) commensurate with the value and level of effort required.
- Define a review process and timeline to evaluate progress and determine whether AE performance warrants incentive payments. The MCO must certify that an AE has met its approved metrics as a condition for the release of associated Health System Transformation Project funds to the AE.
- Minimally require that AEs must submit semi-annual reports to the MCO using a standard reporting form to document progress in meeting quality and cost objectives that would entitle the AE to qualify to receive Health System Transformation Project payments, and that such reports will be shared directly by the MCO with EOHHS.
- Stipulate that the AE must earn payments through demonstrated performance. The AE’s failure to fully meet a performance metric under its AE Health System Transformation Project Plan within the timeframe specified will result in forfeiture of the associated incentive payment (i.e. no payment for partial fulfillment).

Provide a process by which an AE that fails to meet a performance metric in a timely fashion (and thereby forfeits the associated Health System Transformation Project Payment) can reclaim the payment at a later point in time (not to exceed one year after the original performance deadline) by fully achieving the original metric in combination with on-time timely performance on the next metric in the performance sequence.

IX. Program Monitoring, Reporting, & Evaluation Plan

Rhode Island has an established track record of expansions and improvements to its managed care programs as well as a systematic and active program of oversight of our contracted MCOs. The development of the Accountable Entities program provides a new and significant opportunity to further transform the performance of our delivery systems and improve health outcomes for Rhode Island’s Medicaid population.

Rhode Island initiated its first managed care program in 1994 with the enrollment of children and families into its RItE Care program. In the years following there have been many changes in the structure of the program so that it now includes the large majority of Medicaid covered beneficiaries, a broad range of Medicaid covered services with very few service “carve outs”, and an array of program initiatives intended to advance program effectiveness and cost efficiencies. At each step

along the way we have adapted and expanded our program oversight activities to promote high quality performance and ensure program compliance.

Rhode Island's Accountable Entity program is designed to work within and in partnership with our managed care program. Certification of AEs is performed directly by EOHHS, establishing their eligibility to participate in the program. Annual certification ensures continued compliance with requirements to retain eligibility. Eligible AEs will then contract with managed care organizations within the requirements set forth by EOHHS. As the primary contractors with EOHHS, the MCOs will be directly accountable for the performance of their subcontractors. EOHHS is responsible for overseeing compliance and performance of the MCOs in accordance with EOHHS contractual requirements and federal regulation, including performance of subcontractors.

The AE program, AE performance, and MCO-AE relations will be integrated into existing EOHHS managed care oversight activities. For this initiative EOHHS will build upon and enhance its program monitoring and oversight activities in the following four key areas, each of which is described below:

1. MCO Compliance and Performance Reporting Requirements
2. In-Person Meetings with MCOs
3. State Reporting Requirements
4. Evaluation Plan

1. MCO Compliance and Performance Reporting Requirements

Under current contract arrangements, MCOs submit regular reports to EOHHS across a range of operational and performance areas such as access to care, appeals and grievances, quality of care metrics, consumer experience, program operations and others. EOHHS reserves the right to review performance in any area of contractual performance, including flow down requirements to Accountable Entity subcontractors.

For this initiative, MCO reporting requirements that have more typically been provided by the MCOs and reviewed by EOHHS at the plan-level will be extended to also require reporting at the AE level. A menu of metrics and measures that will be used by the MCOs to assess the performance of the AEs

and that will be reported to EHOHHS will be further specified in the final APM guidance document. Areas of current reporting that are under review as requirements for MCOs to report on data aggregated at the Accountable Entity level include:

MCO Required Reports	Description
1. Provider Access Survey Report	Report completed by each Health Plan by the following provider types: primary care, specialty care, and behavioral health for routine and urgent care. This report measures whether appointments made are meeting Medicaid accessibility standards.
2. Provider Panel Report	A report of which provider panels by each Health Plan are at capacity and/or closed to enrollees.
3. Appeal and Grievance Report	An aggregate report of clinical and administrative denials and appeals by each Health Plan, including External Review.
4. Informal Complaint Report	An aggregate report of the clinical and administrative complaints specified by category and major provider sub-groups for each Health Plan
5. Accountable Entity Shared Savings Report	This financial report is included as part of each Health Plan’s risk share report and provides financial data and information as to how each Accountable Entity is performing relative to their total cost of care benchmark.
6. Quality Scorecard	This report consists of the set of NCQA HEDIS and other clinical and quality measures that are used to determine the quality multiplier for total cost of care.
7. MCO Performance Incentive Pool Report	Detailed budgeted and actual MCO expenditures in accordance with EOHHS defined templates

In addition to enhancement of current reports, the Medicaid MCOs will be required to submit reports on a quarterly basis that demonstrate their performance in moving towards value based payment models, including:

- Alternate Payment Methodology (APM) Data Report
- Value Based Payment Report

Pertaining more directly to AE program operations, the Medicaid MCOs will be required to submit Accountable Entity specific reports, including the following.

- AE Attributed Lives
This quarterly report will provide EOHHS with the number of Medicaid MCO lives attributed to each specific Accountable Entity as well as in total.
- AE Population Extract File

This monthly report will provide EOHHS with a member level detailed report of all Medicaid MCO members attributed to each AE. This data will be used by EOHHS for data validation purposes as well as for the purposes of ad-hoc analysis.

- AE Participating Provider Roster

This monthly provider report will provide EOHHS with an ongoing roster of the AE provider network, inclusive of provider type/specialty and affiliation (participating, affiliated, referral etc.) to the Accountable Entity.

2. In-Person Meetings with MCOs

As part of its ongoing monitoring and oversight of its MCOs, EOHHS conducts an in-person meeting on a monthly basis with each contracted MCO. These meetings provide an opportunity for a more focused review of specific topics and areas of concerns. Additionally, they provide a venue for a review of more defined areas of program performance such as quality, finance, and operations. During the initial pilot phase with comprehensive AEs and as the program moves forward, these meetings provide an important forum to identify and address statewide AE performance, emerging issues, and trends that may be impacting the AE program. In addition to the reporting noted above, these meetings support EOHHS' ability to report to CMS (in quarterly waiver reports) issues that may impact AE's abilities to meet metrics or identify factors that may be negatively impacting the program.

In support of discussion on AEs at these meetings, MCOs will be required to submit reports on such areas as:

- A description of actions taken by the MCO to monitor the performance of contracted AEs
- The status of each AE under contract with the MCO, including AE performance, trends, and emerging issues
- A description of any negative impacts of AE performance on enrollee access, quality of care or beneficiary rights
- A mitigation/corrective action plan if any such negative impacts are found/reported

Monthly meetings with MCOs provide a structured venue for oversight. At the same time, EOHHS communications with MCOs take place daily on a variety of topics. Additional meetings to address particular areas of concern that may arise are a routine part of EOHHS' oversight activities. Rhode Island's small size greatly facilitates these in person interactions with both MCOs and AEs.

3. State Reporting Requirements

The state will incorporate information about the Health System Transformation waiver amendment into its existing requirements for waiver reports, including quarterly, annual, and final waiver program reports, and financial/expenditure reports. In addition, the state shall supply separate sections of such reports to meet the reporting requirements in the STCs that are specific to the Health Systems Transformation waiver amendment.

The state will provide quarterly expenditure reports to CMS using Form CMS-64 to report total expenditures for services provided through this demonstration under section 1115 authority subject to budget neutrality. This project is approved for expenditures applicable to allowable costs incurred during the demonstration period. CMS shall provide FFP for allowable demonstration expenditures only as long as they do not exceed the pre-defined limits on the expenditures as specified in Section XVI of the STCs.

The state will also separately report these expenditures by quarter for each FFY on the Form CMS-37 (narrative section) for all expenditures under the demonstration, including HSTP Project Payments, administrative costs associated with the demonstration, and any other expenditures specifically authorized under this demonstration. The report will include:

- A description of any issues within any of the Medicaid AEs that are impacting the AE's ability to meet the measures/metrics.
- A description of any negative impacts to enrollee access, quality of care or beneficiary rights within any of the Medicaid AEs.

4. Evaluation Plan

EOHHS will draft an Evaluation Plan, which will include a discussion of the goals, objectives, and evaluation questions specific to the entire delivery system reform demonstration.

Key areas of attention in the evaluation will tie to the goals and objectives set forth in this Roadmap, as specified in Section II. The draft Evaluation Plan shall list the outcome measures that will be used in evaluating the impact of the demonstration during the period of approval, particularly among the target population. The Evaluation Plan will include a detailed description of how the effects of the demonstration will be isolated from other initiatives occurring within the state (i.e., SIM grant activities). The draft Evaluation Plan will include documentation of a data strategy, data sources, and sampling methodology.

The state will issue an RFP, based on the CMS-approved evaluation plan, for a qualified independent entity to conduct the evaluation. The Evaluation Plan will describe the minimum qualifications of the evaluation contractor, a budget, and a plan to assure no conflict of interest.

- XIV.** **The state plans to submit an Interim Evaluation Report of the Accountable Entities program to CMS by 90 calendar days following the completion of DY 4.** The purpose of the Interim Evaluation Report is to present preliminary evaluation findings and describe plans for completing the evaluation plan. The state also plans to submit a Final Evaluation Report after the completion of the demonstration.

Appendix A: Stakeholder Meetings and Feedback

EOHHS has presented to thirteen (13) stakeholder meetings regarding the HSTP/AE Program.

- HSTP/AE Presentation to ICI Provider Council
- HSTP/AE presentation to 1115 Task Force
- AE/MCO meetings on AE initiative (2 sessions)
- Broad Stakeholder meeting/presentation on Comprehensive AEs (2 sessions)
- Stakeholder meeting on Specialized AEs
- HSTP/AE meeting to home care/child service providers
- NASW Aging Committee meeting
- Coalition for Children presentation
- Governor BH council (scheduled)
- BHDDH Health Transition team (scheduled)
- DEA Home and Community Care Advisory Committee (scheduled)

Additionally, twenty-four (24) comments were received by EOHHS from the following interested parties:

1. Blackstone Valley Community Health Center
2. Carelink
3. Center for Treatment and Recovery
4. CHC ACO
5. Coalition for Children and Families
6. Coastal Medical
7. Disability Law Center
8. Economic Policy Institute
9. Integra
10. Kids Count
11. LeadingAge
12. Lifespan
13. Neighborhood Health Plan of Rhode Island
14. Partnership for Home Care
15. Prospect Health Services of RI
16. Providence Community Health Center
17. RI Coalition for Children
18. RI Community Action Agencies
19. RI Health Care Association
20. RI Health Center Association
21. State of Rhode Island SIM Team
22. Substance Use and Mental Health Leadership Council
23. Tufts Health Public Plans
24. UnitedHealthcare

Many of these comments provided valuable input to the final roadmap as documented here. Some required additional discussion, and were further refined through public input sessions in March 2017, prior to finalizing the roadmap.

Note that the draft roadmap that was posted in January 2017 for comments included both an in-depth discussion of Rhode Island's vision, goals and objectives of Rhode Island's AE program, as well as appendices that outlined initial details of programmatic guidance for AEs. As such, many of the comments received were more directly related to future anticipated guidance – either APM guidance, Incentive Program Guidance or Attribution guidance, and shall be addressed as part of that public input process.

The following is a summary of the comments received by thematic areas.

State Policy Alignment

A number of comments spoke to the need to ensure that state policy outside of the Accountable Entity program was aligned to ensure success. Detailed points of alignment included:

- Statutory authority for data sharing
- Budgetary support for the Integrated Care Initiative, Rhode Island's dual-eligible demonstration program
- Flexibility in Long Term Care Facility Bed Licensing
- Integration of Public Health Initiatives

Overall Program Strategy

Commenters also spoke to the general program strategy and vision as outlined in the roadmap. Frequent comments focused on the following topics:

- *Timeline and milestone expectations* – Many commenters expressed concern at the speed with which the state was proposing to implement the program.
- *Flexibility* – A number of comments spoke with varying degrees of support for the granting of flexibility from the state to MCOs and from MCOs to AEs.
- *Consumer Choice and Access* – Commenters highlighted the need to ensure the protection of consumer choice in the Medicaid program and to protect access to services given the preferred network structure that some AEs may consider developing.

Program Operational Details

Commenters provided significant feedback on operational details that EOHHS will develop further through upcoming guidance documents. Specific areas of feedback included:

- AE Certification
- Alternative Payment Methodologies
- Attribution
- Delegation of Responsibilities
- Incentive Payment Program
- Quality Scorecard

- Reporting and Data Sharing
- Social Service Integration
- Specialized AEs (LTSS)

Appendix C: Roadmap Required Components

	STC Required Elements of Roadmap	Where Addressed
A	(a) Specify that a menu of metrics and measures that will be used by the MCOs to assess the performance of the AEs through the activities of the AE subcontractors shall be defined in the APM guidance document.	<i>Section IX. Program Monitoring, Reporting, & Evaluation Plan</i> <ul style="list-style-type: none"> • Page 35, 1st paragraph
B	(b) Include guidelines requiring AEs to develop individual AE Health System Transformation Project Plans, which shall include timelines and deadlines for the meeting of metrics associated with the projects and activities undertaken to ensure timely performance;	<i>Section VIII. Medicaid Incentive Program (MIIP)</i> <i>Section C. Implementation & Oversight</i> <ul style="list-style-type: none"> • Page 31, in bullets under paragraph titled <i>1. Specifications</i>
C	(c) Report to CMS any issues within the AEs that are impacting the AE’s ability to meet the measures/metrics, or any negative impacts to enrollee access, quality of care or beneficiary rights. The state, working with the MCOs shall monitor statewide AE performance, trends, and emerging issues within and among AEs on a monthly basis, and provide reports to CMS on a quarterly basis.	<i>Section IX. Program Monitoring, Reporting, & Evaluation Plan</i> <ul style="list-style-type: none"> • Page 36, in paragraph titled <i>2. In-Person Meetings with MCOs</i>
D	(d) Provide minimum standards for the process by which EOHHS seek public input in the development of the AE Certification Standards;	<i>Section VI. AE Certification Requirements</i> <ul style="list-style-type: none"> • Page 18, 1st and 2nd paragraphs
E	(e) Specify a State review process and criteria to evaluate each AE’s individual Health System Transformation Project Plan and develop its recommendation for approval or disapproval;	<i>Section VIII. Medicaid Incentive Program (MIIP)</i> <i>Section C. Implementation & Oversight</i> <ul style="list-style-type: none"> • Page 31-32, in paragraph titled <i>2. MCO Review Committee</i>

F	(f) Describe, and specify the role and function, of a standardized, AE-specific application to be submitted to the State on an annual basis for participation in the AE Incentive Program, as well as any data books or reports that AEs may be required to submit to report baseline information or substantiate progress;	<p><i>Section VI. AE Certification Requirements</i></p> <ul style="list-style-type: none"> • Page 18, 1st paragraph <p><i>Section IX: Program Monitoring, Reporting, & Evaluation Plan</i></p> <ul style="list-style-type: none"> • Page 35-36, in paragraph beginning with “Pertaining more directly to AE program operations...”
G	(g) Specify that AEs must submit semi-annual reports to the MCO using a standardized reporting form to document its progress in achieving quality and cost objectives, that would entitle the AE to qualify to receive Health System Transformation Project Payments;	<p><i>Section VIII. Medicaid Incentive Program (MIIP)</i></p> <p><i>Section C. Implementation & Oversight</i></p> <ul style="list-style-type: none"> • Page 32, in paragraph titled 3. <i>Required Structure for Implementation</i>, 4th bullet
H	(h) Specify that each MCO must contract with Certified AEs in accordance with state defined APM guidance and state defined AE Incentive Program guidance. The APM guidance will include a Total Cost of Care (TCOC) methodology and quality benchmarks. For specialized AEs where TCOC methodologies may not be appropriate, other APM models will be specified. Describe the process for the state to review and approve each MCO’s APM methodologies and associated quality gates to ensure compliance with the standards and for CMS review of the APM guidance as stated in STC 47(e).	<p><i>Section VII: Alternative Payment Methodologies</i></p> <ul style="list-style-type: none"> • Page 23, in paragraph titled AE Attributable Populations

I	<p>(i) Specify the role and function of the AE Incentive Program guidance to specify the methodology MCOs must use to determine the total annual amount of Health System Transformation Project incentive payments each participating AE may be eligible to receive during implementation. Such determinations described within the APM guidance document shall be associated with the specific activities and metrics selected of each AE, such that the amount of incentive payment is commensurate with the value and level of effort required; these elements are included in the AE incentive plans referenced in STC 47 (f). Each year, the state will submit an updated APM guidance document, including APM Program guidance and the AE Incentive Program Guidance.</p>	<p><i>Section VIII. Medicaid Incentive Program (MIIP)</i></p> <p><i>Section A. Program Structure</i></p> <ul style="list-style-type: none"> • Page 26, in paragraph titled 3. <i>Accountable Entity Incentive Pool</i> <p><i>Section VIII. Medicaid Incentive Program (MIIP)</i></p> <p><i>Section C. Implementation & Oversight</i></p> <ul style="list-style-type: none"> • Page 31-32, in paragraph titled 2. <i>MCO Review Committee</i>, 3rd bullet • Page 32, in paragraph titled 3. <i>Required Structure for Implementation</i>, in 2nd bullet, 4th sub-bullet
J	<p>(j) Specify a review process and timeline to evaluate AE progress on its Health System Transformation Project Plan metrics in which the MCO must certify that an AE has met its approved metrics as a condition for the release of associated Health System Transformation Project funds to the AE;</p>	<p><i>Section VIII. Medicaid Incentive Program (MIIP)</i></p> <p><i>Section C. Implementation & Oversight</i></p> <ul style="list-style-type: none"> • Page 32, in paragraph titled 3. <i>Required Structure for</i>
		<p><i>Implementation</i>, in 3rd bullet</p>
K	<p>(k) Specify that AE's failure to fully meet a performance metric under its AE Health System Transformation Project Plan within the time frame specified will result in forfeiture of the associated incentive payment (i.e., no payment for partial fulfillment);</p>	<p><i>Section VIII. Medicaid Incentive Program (MIIP)</i></p> <p><i>Section C. Implementation & Oversight</i></p> <ul style="list-style-type: none"> • Page 32-33, in paragraph titled 3. <i>Required Structure for Implementation</i>, 5th bullet
L	<p>(l) Describe a process by which an AE that fails to meet a performance metric in a timely fashion (and thereby forfeits the associated Health System Transformation Project Payment) can reclaim the payment at a later point in time (not to exceed one year after the original performance deadline) by fully achieving the original metric in combination with timely performance on a subsequent related metric,</p>	<p><i>Section VIII. Medicaid Incentive Program (MIIP)</i></p> <p><i>Section C. Implementation & Oversight</i></p> <ul style="list-style-type: none"> • Page 32-33, in paragraph titled 3. <i>Required Structure for Implementation</i>, 6th bullet

M	(m) Include a process that allows for potential AE Health System Transformation Project Plan modification (including possible reclamation, or redistribution, pending State approval) and an identification of circumstances under which a plan modification may be considered, which shall stipulate that CMS may require that a plan be modified if it becomes evident that the previous targeting/estimation is no longer appropriate or that targets were greatly exceeded or underachieved; and	<p><i>Section VIII. Medicaid Incentive Program (MIIP)</i></p> <p><i>Section B. Program Spending Guidance</i></p> <ul style="list-style-type: none"> • Page 31, 2nd paragraph
N	(n) Include a State process of developing an evaluation of Health System Transformation Project as a component of the draft evaluation design as required by STC 132.	<p><i>Section IX. Program Monitoring, Reporting, & Evaluation Plan</i></p> <ul style="list-style-type: none"> • Page 37, in paragraph titled <i>4. Evaluation Plan</i>

**Attachment M: Accountable Entity- Specific Health Transformation Project Plan
See Attachment N**

Attachment N: Reserved

Attachment O: Claiming Protocol – Other DSHPs

Introduction

The Special Terms and Conditions (STCs) of Rhode Island’s Section 1115(a) Demonstration #11-W-00242/1 approved by the Centers for Medicare and Medicaid Services (CMS) on October 20, 2016, provides expenditure authority to Rhode Island (RI) Medicaid for Designated State Health Programs. Accordingly, Rhode Island Medicaid established Designated State Health Programs (DSHPs) to permit Federal Financial Participation (match) claiming for DSHP expenditures that provide or support the provision of health services in Rhode Island.

Under this approval, the following Designated State Health Programs (also termed “Program Group(s)”, “Program” or “Agency”) were established and are listed below with their respective claiming protocol Attachment:

- Attachment P (“Other DSHPs”)
 - Tuberculosis Clinic
 - Center for Acute Infectious Disease Epidemiology
 - Rhode Island Child Audiology Center at the RI School for the Deaf
 - Consumer Assistance Programs
 - Office of the Child Advocate
 - Commission on the Deaf and Hard of Hearing
- Attachment Q
 - Wavemaker Fellowship
- Attachment S
 - Health Workforce Development (RI Public Institutions of Higher Education*)
**Includes Community College of Rhode Island, Rhode Island College, University of Rhode Island*

Through these DSHPs, additional CNOM (Costs Not Otherwise Matchable) activities have been identified for which Federal Financial Participation (FFP) may be claimed. Allowable DSHP claims for each Program are limited to the allowable DSHP costs (“Allowable Costs” or expenditures) incurred for the months of the time period defined by the STCs. Under the STCs, the state cannot begin to claim FFP for any of the DSHPs until the corresponding protocols are approved. Upon CMS approval of each DSHP claiming protocol, the state may claim FFP for the corresponding approved DSHP expenditures beginning with the date these STCs were approved, October 20, 2016.

This document, Attachment P to those STCs, addresses the “Other DSHPs”. Separate Protocols are established for the Wavemaker Fellowship DSHP - Attachment Q, and the Health Workforce Development DSHP - Attachment S. This document along with Attachments Q and S are attachments to those STCs and articulate the protocol for determination of DSHP expenditures eligible for FFP, describe the claiming and reporting methods and identify the records required to be maintained to support the STCs relating to the DSHPs.

All claimable DSHP expenditures will be made from the State’s general funds and do not include any expenditures that are used to meet any federal maintenance of effort requirements nor to provide match for any other federal purpose or grant. Additionally, allowable DSHP expenditures do not

include expenditures associated with the provision of non-emergency care to non-qualified aliens. To implement this limitation, a reduction of 9 percent of total expenditures of the Tuberculosis Clinic, Center for Acute Infectious Disease and Epidemiology and the Consumer Assistance Program DSHPs will be treated as expended for non-emergency care to non-qualified aliens and eliminated from amounts claimed.

Rhode Island Medicaid will enter into an Interagency Service Agreements (ISA) with each of these Other DSHPs or their parent State agency. Each Agreement will specify what can count as a DSHP expenditure, documentation requirements for the expenditure, and an assurance that the DSHP gives RI Medicaid authority to submit the claim based on their documented, eligible DSHP expenditures. In accordance with the ISA, each DSHP or administering Agency will provide verification that the DSHP eligible expenses are accurate and complete and are based on the instructions provided in this claiming protocol.

DSHP Authority

The relevant authorizing language in the STCs (STC 84) states that Rhode Island may claim FFP for expenditures for each of the Other DSHPs follows:

- 1) **“Tuberculosis Clinic- Department of Health** - the state may claim FFP for expenditures otherwise uncompensated by Medicaid or third party payers that are incurred by the Tuberculosis Clinic within the Rhode Island Department of Health but are attributable to Medicaid and other low-income patients. The Tuberculosis Clinic is responsible for TB surveillance to detect cases and assures the availability of TB Specialty Clinical Services (adult and pediatric clinical services) to improve health outcomes and increase the efficiency and quality of care to all Rhode Island citizens.
- 2) **Rhode Island Child Audiology Center- RI School for the Deaf** - the state may claim FFP for expenditures otherwise uncompensated by Medicaid or third party payers that are incurred by the Rhode Island Child Audiology Center- RI School for the Deaf but are attributable to Medicaid and other low-income patients. The Audiology Center provides statewide hearing screening for children at all Rhode Island schools and will provide further diagnostic testing and referral for treatment for any child who screens at-risk for hearing loss.
- 3) **Center for Acute Infectious Disease Epidemiology- RI Department of Health** - the state may claim FFP for expenditures otherwise uncompensated by Medicaid or third party payers that are incurred by the state’s Center for Acute Infectious Disease Epidemiology within the Rhode Island Department of Health and are attributable to Medicaid and other low income patients. This program conducts surveillance, clinical case review and disease investigation for reportable infectious diseases to case manage, investigate and track diseases to reduce and control infectious diseases.
- 4) **Consumer Assistance Programs- Executive Office of Health and Human Services** - the state may claim FFP for expenditures related to the two specific programs within the Consumer Assistance Programs - Executive Office of Health and Human Services:
 - i) The Office of the Child Advocates (OCA) is an independent state agency responsible for protecting the legal rights and interests of all children in state care. These rights

include, but are not limited to, a child's right to healthcare and education.

- ii) The Commission on the Deaf and Hard of Hearing (CDHH) coordinates, and provides services committed to promoting an environment in which the Deaf and Hard of Hearing in Rhode Island are afforded equal opportunity in all aspects of their lives”.

The following section discusses the expenditure preparation, validation and submission procedures.

Expenditures Claimable for FFP

The Allowable Costs for each DSHP under this protocol is determined by each Agency identifying the allowable total costs (expenditures) recorded by the Agency in the State's Accounting System (RIFANS) during the respective fiscal quarter being reported.

Each Agency uses Rhode Island's accounting system for all its accounting transactions which classifies expenditures using State designated transaction coding, procedures and internal controls and approval processes. The chart of accounts structure in RIFANS includes these primary coding structure elements which are relevant for Allowable Cost reporting: agency, fund, transaction date, expense account category, expense amount and description. Transactions in the system require these coding structures to store, process, and report out expenditures for all programs, including the programs to be claimed under these DSHPs.

All expenditures to be claimed under this Protocol are recorded in the State's financial statements which are audited annually by the Rhode Island Auditor General and included each year in the State's Comprehensive Annual Financial Report (CAFR). The allowable costs will be guided by the standards defined in the Office of Management and Budget (OMB) circular, effective December 26, 2013, "Uniform Administrative Requirements, Cost Principles, and Audit Requirements for Federal Awards", defined at 2CFR 200.402, as amended from time to time (also called "Super-circular"). Additionally, as a State Agency, all transactions are recorded in the accordance with generally accepted accounting principles (GAAP) as promulgated by the Governmental Accounting Standards Board.

Using the State's accounting system, the Agency will identify the allowable expenditures, as described above, incurred in a quarter commencing with the date of CMS approval of the STCs (October 20, 2016) and will complete and submit the "DSHP Allowable Cost Report" (**Exhibit B**) to EOHHS no later than 40 calendar days after the end of the quarter in which the expenditures occur. All expenses claimed under this DSHP protocol must be auditable and comply with all State approval and processing procedures and be properly authorized, documented, and recorded in the State accounting system. All data included in **Exhibit B** will be subject to audit and the DSHP will retain sufficient documentation for each expenditure to withstand audit.

Expenditure Verification

Along with the completed "DSHP Allowable Cost Report", the Agency will provide an "Expenditure Verification" (EV) (**Exhibit A**) to this Claiming Protocol attesting that the reported expenditures are accurate and in accordance with this Claiming Protocol, include only allowable costs and are not used as match or MOE (Maintenance of Effort) for any federal grants nor for any federal program or grant.

Expenditure Substantiation

The Agency will provide reports of expenditures made as required by this claiming protocol and provide reports, procedure narratives and such other documentation as requested by EOHHS as

needed for audit or such other compliance or documentation purposes as arise from time to time. If EOHHS requests it, the Agency shall provide detailed records supporting the expenditure statement including records that document verified expenditures, and to the extent any personally identifiable records are relevant, provision of such records is subject to and shall be in conformity with applicable provisions of the Family Educational Rights and Privacy Act (FERPA) and/or the Health Insurance Portability and Accountability Act (HIPAA).

Claiming for DSHP Funds

Upon receipt of **Exhibit A** with **Exhibit B** from the Agency, EOHHS shall approve or reject any such expenditure statement, or request additional information within 10 business days after receipt by EOHHS. EOHHS shall provide the Agency with a written explanation if any statement is rejected and, if the Agency requests it, agrees to meet with Agency personnel to provide the Agency a reasonable opportunity to understand the basis of the rejection and an opportunity to amend the statement of expenditures to resolve any questions EOHHS has and, if possible, remove any obstacles to inclusion of the expenditures in the State's expenditure report to CMS.

Provided that EOHHS determines that the Agency expenditures described herein and verified by the Agency would qualify for FFP and satisfy the federal time limits for claiming, EOHHS shall include the amount of such expenditures in its Quarterly Medicaid Assistance Expenditures ("CMS 64") report for purposes of claiming FFP for those expenditures. In order to provide CMS with timely assurance and support for the DSHP payments, the State will document through the respective quarterly report to CMS the expenditure detail supporting the request for DSHP payments.

Changes to Previously Claimed Amounts

EOHHS shall inform the Agency of any communication and provide the Agency with a copy of any letter or other communication from state or federal officials or staff relating to questions, audits, review, request for information, deferral, recoupment or disallowance of FFP for expenditures verified by the Agency.

The Agency shall inform EOHHS of any communication and provide EOHHS with a copy of any letter or other communication from state or federal officials or staff relating to questions, audits, review, request for information, deferral, recoupment or disallowance of FFP for expenditures verified by the Agency pursuant to this Protocol.

RI EOHHS reserves the right to submit DSHP qualifying and allowable expenditures received from the Agency after 40 days for FFP claiming as long as the expenditures were incurred no more than 2 years prior to the date of FFP claim, in accordance with the federal regulation at 45 CFR Part 95, Subpart A.

Exhibit A

EXHIBIT A: EXPENDITURE VERIFICATION (EV) FORM

(See next page for form; MS Word version imbedded here for use)



Exhibit A - Other
DSHP EV draft_04.17

The State of Rhode Island and Providence Plantations Medicaid Agency (EOHHS) requires certain information to enable EOHHS to recognize costs incurred for services rendered for Designated State Health Program (DSHP) as allowable expenditures. The Expenditure Verification (EV) form provides EOHHS with verification of expenditures by the HSTP which will allow EOHHS to draw federal matching funds.

This mandatory form will be retained as part of the fiscal documentation for EOHHS. The completed and signed EV form must be submitted to the attention of the HSTP Program Director by FAX to (401) 462-4652; by email to paul.loberti@ohhs.ri.gov or mailed to:

Paul G. Loberti, MPH
 RI EOHHS Administrator for Medical Services & HSTP Program Director
 Hazard Building
 74 West Road
 Cranston, RI 02920

SECTION I – AGENCY INFORMATION

Report Period Number	Federal Provider Identification
--------------------------------	--

Name and Address – Agency

SECTION II - VERIFICATION

This is to verify that:

- I am authorized to review, sign, and submit this form on behalf of this Rhode Island Agency.
- This DSHP expended \$ _____ in general funds for this eligible Rhode Island Designated State Health Program (DSHP), as approved by CMS October 20, 2016 in the 11-W-00242/1 amendment to Rhode Island’s section 1115 Demonstration Waiver. The attached Exhibit B is the Allowable Cost report showing the expenditures identified for this approved DSHP program during this report period.
- The report period for this verification is: _____ (mm-dd-yy), through _____ (mm-dd-yy).
- These expenditures do not include costs used to meet federal maintenance of effort requirements nor to provide match for any other federal purpose or grant.
- Records documenting these expenditures are available for audit by EOHHS.
- I have reviewed the foregoing and verify that the information reported is true and correct to the best of my knowledge and belief.

SECTION III – SIGNATURE

SIGNATURE – Authorized Representative	Date Signed
--	--------------------

Exhibit B

Name – Authorized Representative (print)

Telephone Number – Authorized Representative

Title – Authorized Representative

Email Address – Authorized Representative

EXHIBIT B: DSHP ALLOWABLE COST REPORT

(See below for example of forms Exhibit B; MS Excel version imbedded here for use)



Exhibit B - Other
DSHP Allowable Cos



DSHP Allowable Cost Reporting

DSHP Name: _____

Fiscal Quarter: _____

Agency Administering DSHP, if different from DSHP _____

	(a)	(b)	(c)	(d)	(e)
Line #	Expense Description	Total Allowable Costs this quarter	Prior Cumulative Allowable Costs	Cumulative Allowable Costs	
1	Salaries	-	-	-	
2	Benefits	-	-	-	
3	Operating, Supplies and Expenses	-	-	-	
4	Contractual Services	-	-	-	
5	List, if necessary	-	-	-	
6	List, if necessary	-	-	-	
7	List, if necessary	-	-	-	
8	List, if necessary	-	-	-	
9	List, if necessary	-	-	-	
10	List, if necessary	-	-	-	
	Total Costs	\$ -	\$ -	\$ -	

EXHIBIT B

Instructions

Enter Agency/ Name

Enter Fiscal Quarter to which report applies

Enter Name of Agency Administering DSHP, if not DSH

In Column '(c)' enter the \$ amount of the respective expense from RIFANS for the quarter.
 In Column '(d)', enter the previously submitted cumulative costs.
 Column '(e)' will automatically populate.

Provide additional supporting detail as and when required by EOHHS under this Claiming Protocol.

Attachment P: Wavemaker Methodology and Claiming Protocol

Introduction

The Special Terms and Conditions (STCs) of Rhode Island's Section 1115(a) Demonstration #11-W-00242/1 approved by the Centers for Medicare and Medicaid Services (CMS) on October 20, 2016, approved expenditure authority to Rhode Island (RI) Medicaid for Designated State Health Programs. Accordingly, Rhode Island Medicaid established Designated State Health Programs (DSHPs) to permit Federal Financial Participation claiming for DSHP expenditures that provide or support the provision of health services in Rhode Island.

Under this approval, the following Designated State Health Programs (also termed "Program Group(s)", "Program" or "Agency") were established and are listed below with their respective claiming protocol Attachment:

- Attachment Q
 - Wavemaker Fellowship
- Attachment P ("Other DSHPs")
 - Tuberculosis Clinic
 - Center for Acute Infectious Disease Epidemiology
 - Rhode Island Child Audiology Center at the RI School for the Deaf
 - Consumer Assistance Programs
 - Office of the Child Advocate
 - Commission on the Deaf and Hard of Hearing
- Attachment S
 - Health Workforce Development (RI Public Institutions of Higher Education*)
**Includes Community College of Rhode Island, Rhode Island College, University of Rhode Island*

Through these DSHPs, additional CNOM (Costs Not Otherwise Matchable) activities have been identified for which Federal Financial Participation ("FFP" or "match") may be claimed. Allowable DSHP claims for each Program are limited to the allowable DSHP costs ("Allowable Costs" or expenditures) incurred for the months of the time period defined by the STCs. Under the STCs, the state cannot begin to claim FFP for any of the DSHPs until the corresponding protocols are approved. Upon CMS approval of each DSHP claiming protocol, the state may claim FFP for the corresponding approved DSHP expenditures beginning with the date the STCs were approved, October 20, 2016.

This document, Attachment Q to those STCs, addresses the "Wavemaker Fellowship" sponsored by the Rhode Island Commerce Corporation (Commerce, Corporation or Agency) and established under RI General Law 42.64.26. As a quasi-public organization, the Rhode Island Commerce Corporation is a component unit of the State of Rhode Island and funded through an appropriation from the Rhode Island General Assembly as well as through bonds issued by the Corporation, donations and fees for services. Separate Protocols are established for the Other DSHPs, Attachment P, and the Health Workforce Development DSHP, Attachment S. This document along with Attachments P and S are attachments to those STCs and articulate the protocol for determination of DSHP expenditures

eligible for FFP, describe the claiming and reporting methods and identify the records required to be maintained to support the STCs relating to the DSHPs.

All claimable DSHP expenditures will be made from the State's general funds and do not include any expenditures that are used to meet any federal maintenance of effort requirements nor to provide match for any other federal purpose or grant.

Rhode Island Medicaid will enter into an Interagency Service Agreements (ISA) with the Commerce Corporation. The Agreement will specify what can count as a DSHP expenditure, documentation requirements for the expenditure, and an assurance that the DSHP gives RI Medicaid authority to submit the claim based on their documented, eligible DSHP expenditures. In accordance with the ISA, the Agency will provide verification that the DSHP eligible expenses are accurate and complete and are based on the instructions provided in this claiming protocol.

DSHP Authority

The relevant authorizing language in the STCs (STC 84) states that Rhode Island "may claim FFP for expenditures under the Wavemaker Program. The Wavemaker Fellowship is a state-funded loan repayment program. The Wavemaker Fellowship will allow for graduates working in the healthcare settings to serve and make an impact on the health care of Medicaid beneficiaries".

The following describes the Wavemaker Fellowship program included in this claiming protocol.

Program Background

The Wavemaker Fellowship provides a financial incentive for recent college graduates to work in RI by defraying student loan payments for up to four years for graduates pursuing careers and employed in positions in Rhode Island in areas of health care, medicine, medical device technology, natural or environmental sciences, computer, information or software technology; advanced mathematics, finance; engineering, industrial or other commercial design fields.

To be eligible, an applicant for the Fellowship must have incurred student loan debt during the completion of an associate's, bachelor's, or graduate degree and must work in Rhode Island in a designated field. A fellowship committee convened by the Corporation selects fellowship recipients from among the qualified applicants using a competitive, merit-based process.

Fellowship awardees receive an annual award for up to four years in the form of a cash payment or a redeemable tax credit against their Rhode Island income tax to defray the cost of student loan repayments. The award will equal the fellow's annual loan repayment expenses subject to the following caps: \$6,000 for a fellow with a graduate degree, \$4,000 for a fellow with a bachelor's degree, and \$1,000 for a fellow with an associate's degree. "Eligible Expenses" means annual higher education loan repayment expenses, including, without limitation, principal, interest and fees, as may be applicable, incurred by an eligible graduate and which the eligible graduate is obligated to repay for attendance at a postsecondary institution of higher learning. Notwithstanding the foregoing, late fees or other penalties for late payment shall not constitute Eligible Expenses". The Fellowship is awarded and paid by the Rhode Island Commerce Corporation.

The application period is typically in the second quarter of the calendar year, with awardees named in the third quarter, and award payments made only after a 12-month qualifying service period is

demonstrated. These award payments are typically made in the fourth quarter of the following calendar year. For example, an awardee named in June 2017 receives the payment/credit in October 2018. That is, the award is realized (paid) only after an individual actually works for a full year in a qualifying position in RI.

The full text of the Wavemaker Fellowship regulations and the enacted governing legislation can be found at <http://commerceri.com/finance-business/taxes-incentives/wavemaker-fellowship/>.

Expenditures Claimable for FFP

Using the Corporation's accounting system, the Corporation will identify the payments made to the certified awardees (the "Allowable Expenditures") as described above, incurred in a year commencing with the date of CMS approval of the STCs (October 20, 2016) and will complete and submit the "Wavemaker Allowable Expenditure Report" template in **Exhibit B** to EOHHS no later than 40 calendar days after the end of the quarter in which the payment occurs.

In the "Wavemaker Allowable Expenditure Report", the Corporation will submit a list of those Fellows receiving the award for which FFP will be claimed utilizing the Corporation's database which tracks Fellowship awards, job, and employer information.

The Commerce Corporation validates and authorizes the payment/credit of an award by identifying the number of participating graduates and loan repayment amounts as follows:

- A. Within six (6) months after the end of each Award year, a Fellowship Recipient submits a certification to the Commerce Corporation certifying:
 - (1) The amount the Fellowship Recipient has actually incurred and paid in Eligible Expenses;
 - (2) The Fellowship Recipient continues to meet the eligibility requirements of employment with an "eligible Rhode Island based employer", as defined in the Wavemaker regulations, throughout the year of employment;
 - (3) The amount sought in Fellowship Award does not exceed the original loan amount; and,
 - (4) The Fellowship Recipient is current on his or her student loan repayment obligations.
- B. Upon a review of the submission and determination that the Fellowship Recipient has met the requirements specified in the Award Letter, the Corporation will issue an Annual Certification to the Fellowship Recipient providing entitlement to the issuance of a Tax Credit Certificate for a specified year in an amount determined pursuant to the Award Letter;
- C. The Awardee must make a one-time election to receive the award in cash or as a tax credit.

Expenditure Verification

Along with the completed "Wavemaker Allowable Expenditure Report" the Corporation will provide an Expenditure Verification form (**Exhibit A** to this Claiming Protocol) attesting that the reported expenditures are accurate in accordance with this Claiming Protocol, include only Allowable Expenditures, are not used as match or MOE (Maintenance of Effort) for any federal grants, and are funded by the State's annual appropriation for the Wavemaker program permitted by this Claiming Protocol.

Expenditure Substantiation

The Agency will provide reports of expenditures made as required by this claiming protocol and provide reports, procedure narratives and such other documentation as requested by EOHHS as needed for audit or such other compliance or documentation purposes as arise from time to time. If EOHHS requests it, the Agency shall provide detailed records supporting the expenditure statement including records that document verified expenditures, and to the extent any personally identifiable records are relevant, provision of such records is subject to and shall be in conformity with applicable provisions of the Family Educational Rights and Privacy Act (FERPA) and/or the Health Insurance Portability and Accountability Act (HIPAA).

All expenditures to be claimed under this Protocol are included in the Corporation's annual financial statements audited by an external public accounting firm which are included in the State's Comprehensive Annual Financial Report (CAFR) audited annually by the Rhode Island Auditor General. Additionally, as a State Agency, all transactions are recorded in the accordance with generally accepted accounting principles (GAAP) as promulgated by the Governmental Accounting Standards Board.

Claiming for DSHP Funds

Upon receipt of **Exhibit A** with **Exhibit B** from the Corporation, EOHHS will approve or reject any such Expenditure Verification statement, or request additional information within 10 business days after receipt by EOHHS. EOHHS shall provide the Corporation with a written explanation if any statement is rejected and, if the Corporation requests it, agrees to meet with Corporation personnel to provide a reasonable opportunity to understand the basis of the rejection and an opportunity to amend the statement of expenditures to resolve any questions EOHHS has and, if possible, remove any obstacles to inclusion of the expenditures in the State's expenditure report to CMS.

Provided that EOHHS determines that the Corporation's expenditures described herein and verified by the Corporation would qualify for FFP and satisfy the federal time limits for claiming, EOHHS shall include the amount of such expenditures in its Quarterly Medicaid Assistance Expenditures ("CMS 64") report for purposes of claiming FFP for those expenditures in the quarter in which the claim is made. In order to provide CMS with timely assurance and support for the DSHP payments, the State will document through the respective quarterly report to CMS the expenditure detail supporting the request for DSHP payments.

RI EOHHS reserves the right to submit DSHP qualifying and allowable expenditures received from the Corporation after 40 days for FFP claiming as long as the expenditures were incurred no more than 2 years prior to the date of FFP claim, in accordance with the federal regulation at 45 CFR Part 95, Subpart A.

Changes to Previously Claimed Amounts

EOHHS shall inform the Commerce Corporation of any communication and provide the Corporation with a copy of any letter or other communication from state or federal officials or staff relating to questions, audits, review, request for information, deferral, recoupment or disallowance of FFP for expenditures certified by the Corporation.

The Commerce Corporation shall inform EOHHS of any communication and provide EOHHS with a copy of any letter or other communication from state or federal officials or staff relating to questions, audits, review, request for information, deferral, recoupment or disallowance of FFP for expenditures certified by the Corporation pursuant to this Protocol.

Wavemaker Fellowship Workforce Methodology

The Wavemaker Fellowship promotes HSTP goals by providing a financial incentive for graduates to pursue a health care career in Rhode Island. The Wavemaker Fellowship promotes careers in health care by providing loan repayment for graduates working in a Rhode Island healthcare setting that serves Medicaid enrollees.

The work under the Wavemaker DSHP will be closely integrated and aligned with the goals and strategies of the larger Health Care Workforce Development effort (Attachment R to the STCs). In particular, funds from the Wavemaker DSHP will be used to support Workforce Development efforts, with a primary focus on recruiting graduates to work in RI by increasing enrollment of entry level health professional graduates into the Wavemaker Program. This will be combined with a broad effort to recruit and retain health professionals in RI through education and recruitment about Wavemaker at colleges and universities as well as Medicaid providers.

EOHHS and the Commerce Corporation, with the support of the overall Workforce Development effort (Attachment R), will work with the three state colleges/universities as well as private colleges/universities to assist in identifying graduates who may qualify for the Wavemaker opportunity and with provider organizations that serve Medicaid enrollees and employ healthcare graduates. This will maximize the Wavemaker loan repayment opportunity in order to attract new hires to RI's health care workforce, in particular to positions where there is an unmet staffing need. The Wavemaker DSHP will assist in the accomplishment of the following goal and objectives of the larger Health Care Workforce Development effort as stated in Attachment R.

Goal: Healthcare Career Pathways: Skills That Matter for Jobs That Pay: Prepare Rhode Islanders from culturally and linguistically diverse backgrounds for existing and emerging good jobs and careers in healthcare through expanded career awareness, job training and education, and advancement opportunities.

- Support the Entry-Level Workforce through improving recruitment, retention, and career advancement: the increase in funding will allow the Corporation to expand recruiting efforts to those in the healthcare professions thereby increasing enrollment of health care professions graduates in the Wavemaker program;
- Increase the cultural, ethnic, and linguistic diversity of licensed health professionals by recruiting an increasingly diverse group of health care graduates into the Wavemaker Program through the targeted recruiting efforts;
- Address Provider Shortages: Remediate shortages among certain health professions through the targeted recruitment efforts into the Wavemaker Program targeting the newly graduating health professionals to work in areas of health care professional shortage.

The State will follow the methodology above which will ensure that funds generated as a result of Wavemaker DSHP claiming will improve access and quality of services to the Medicaid population.

Annual Reporting

Beginning January 31, 2018, and annually thereafter, to show reinvestment in Health Care workforce, the Corporation will provide historical comparative data for the most recent Fellowship awards from the Corporation's database which will include a:

- List of Fellowship awards with employer.
- List of Fellowship awardees who have fulfilled their annual work commitment by working with a Health Care (Medicaid) provider serving Medicaid members and a description of the specific health care/medical job (job placement and employer information) in RI for each Health Care Fellowship awarded and paid.

Updates will be provided quarterly, as available.

Exhibit A

Exhibit A: Expenditure Verification (EV) Form

(See next page for form; MS Word version imbedded here for use)



Exhibit A -
Wavemaker EV draft



**Designated State Health Program
EXPENDITURE VERIFICATION**

The State of Rhode Island and Providence Plantations Medicaid Agency (EOHHS) requires certain information to enable EOHHS to recognize expenditures incurred for Designated State Health Program (DSHP) as allowable expenditures. The Expenditure Verification (EV) form provides EOHHS with verification of expenditures by the Agency which will allow EOHHS to draw federal matching funds.

This mandatory form will be retained as part of the fiscal documentation for EOHHS. The completed and signed EV form must be submitted to the attention of the HSTP Program Director by FAX to (401) 462-4652; by email to paul.loberti@ohhs.ri.gov or mailed to:

Paul G. Loberti, MPH
RI EOHHS Administrator for Medical Services & HSTP Program Director
Hazard Building
74 West Road
Cranston, RI 02920

SECTION I – AGENCY INFORMATION

Report Period	Federal Provider
Identification Number	

Name and Address – Agency

SECTION II - VERIFICATION

This is to verify that:

- I am authorized to review, sign, and submit this form on behalf of this Rhode Island Agency.
- This Agency recorded \$ _____ in Wavemaker Fellowship awards for this Rhode Island Designated State Health Programs (DSHP), as approved by CMS October 20, 2016 in the 11-W-00242/1 amendment to Rhode Island’s section 1115 Demonstration Waiver. Attached in Exhibit B, is the report showing the expenditures identified for the approved DSHP program.
- The report period for this verification is: _____(mm-dd-yy), through _____(mm-dd-yy).
- These expenditures do not include costs used to meet federal maintenance of effort requirements nor to provide match for any other federal purpose or grant.
- Records documenting these Fellowship awards are available for audit by EOHHS.
- I have reviewed the foregoing and verify that the information reported is true and correct to the best of my knowledge and belief.

SECTION III – SIGNATURE

SIGNATURE – Authorized Representative	Date Signed
Name – Authorized Representative (print) Representative	Telephone Number – Authorized
Title – Authorized Representative	Email Address – Authorized Representative

Exhibit B: Wavemaker Allowable Expenditure Report

(See below for example of form; MS Excel version imbedded here for use)



Exhibit B -
Wavemaker Expendi

Wavemaker Fellowship Expenditure Report

Complete the table below of totals of Wavemaker Fellowship expenditures for the period reported.

Expenditures for Period: _____

(a)	(b)	(c)	(d)	(e)
Line #	Awardee Name	Employer	Job Title	\$ Award Expenditure
1	<i>(First Name, Last Initial)</i>			
2	<i>(First Name, Last Initial)</i>			
3	<i>(First Name, Last Initial)</i>			
4	<i>(First Name, Last Initial)</i>			
5	<i>(First Name, Last Initial)</i>			
6	<i>(First Name, Last Initial)</i>			
7	<i>(First Name, Last Initial)</i>			
8	<i>(First Name, Last Initial)</i>			
9	<i>(First Name, Last Initial)</i>			
10	<i>Insert as many lines as needed</i>			
Total Fellowship Expenditure for the Period				\$ -

Column	Instructions
(b)	Insert the Awardee's name, for privacy purposes provide only First Name and Last Initial. Commerce will retain the detail by full name for audit purposes and if requested by EOHHS.
(c)	Insert the name of the Awardee's Employer.
(d)	Insert the Awardee's Job Title.
(e)	Insert the total dollar amount of the Fellowship expenditure to the Awardee for the period.

Attachment Q: Health Workforce Development Protocol

Introduction

The Special Terms and Conditions (STCs) of Rhode Island’s Section 1115(a) Demonstration #11-W-00242/1 approved by the Centers for Medicare and Medicaid Services (CMS) on October 20, 2016, provides expenditure authority to Rhode Island (RI) Medicaid for Designated State Health Programs. Accordingly, Rhode Island established a Health Workforce Development (HWD) Designated State Health Program (DSHP) enabling Rhode Island to promote improved access and quality of care for Medicaid beneficiaries in the State by supporting the education and training of the health care workforce. Specifically, STC 85 states “to ensure that DSHP funds promote the development of workforce training to benefit the Medicaid population and improve access, the State shall commit to implementing the Health Workforce Development Methodology Protocol that will be **Attachment R**”.

This document is **Attachment R** to those STCs. The methodology described herein includes: a) the planning efforts Rhode Island has undertaken for workforce development; b) the State, higher education and provider collaboration efforts that have occurred to identify the current environment, needs for the workforce, and plans for continued collaboration; c) the workforce development strategies resulting from the analysis of the previous collaboration efforts; and, d) an outline of the implementation plan the State has defined to achieve the workforce development improvements.

I. Planning and Collaboration

On February 26, 2015, Governor Gina Raimondo issued Executive Order 15-08, establishing the “Working Group to Reinvent Medicaid.” In July 2015, the Working Group delivered a multi-year plan for the transformation of the Rhode Island Medicaid program, “*towards a system that pays for the outcomes and quality of care Rhode Islanders deserve, and that addresses the complex medical and social needs critical to achieving improved health status.*” Working with partners from the health care sector, the advocacy community, the business community at large, the Executive Office of Health and Human Services (EOHHS) laid out a model for a reinvented publicly financed health care system in Rhode Island based on the following principles:

- Pay for value, not for volume
- Coordinate physical, behavioral, and long-term health care
- Rebalance the delivery system away from high-cost settings
- Promote efficiency, transparency, and flexibility

None of these changes in healthcare are possible without a transformed workforce, with the right workers with the right skills, in the right place, at the right time. Recognizing this need, RI Medicaid under the Executive Office for Health and Human Services (EOHHS) launched a Healthcare Workforce Transformation (“HWT” also “HWD”) (Healthcare Workforce Development) planning process in June, 2016, to assess Rhode Island’s current and projected healthcare workforce

needs and educational capacity, and to identify priorities and strategies to align healthcare workforce education and training programs with the objectives of the State's Health System Transformation Program (HSTP).

The HWT process involved the active participation of more than two-hundred fifty (250) healthcare partners representing providers, educators, policy-makers, payers, community-based organizations, advocates, professional associations and labor organizations. This process included regular meetings of a twenty-person Advisory Committee, three large stakeholder meetings, thirty one-on-one interviews, and seven small group discussions on a variety of health focus areas including primary care, behavioral health, social determinants and cultural competence, health information technology, home and community-based care, chronic disease, and oral health. The focus of these efforts was to identify the knowledge, skills, training, and experience that will be needed by the current and future healthcare workforce to support health system transformation.

II. Strategies

This initial planning phase of the EOHHS HWT initiative culminated in early May, 2017 with the publication of the EOHHS Healthcare Workforce Transformation Report (Report), which includes data (labor market, education, and licensure), best practices (national and local), a compendium of “transformative” occupations, and an inventory of healthcare workforce development resources in RI. Most importantly, the Report identifies the following priorities and strategies to guide the State’s support for, and development of, the healthcare workforce that RI will need to achieve the goals of the Health System Transformation Project.

1. *Healthcare Career Pathways: Skills That Matter for Jobs That Pay

Prepare Rhode Islanders from culturally and linguistically diverse backgrounds for existing and emerging good jobs and careers in healthcare through expanded career awareness, job training and education, and advancement opportunities. **Strategies:**

- ***Support the Entry-Level Workforce:** Improve recruitment, retention, and career advancement.
In order to support RI Medicaid’s goal to rebalance the system away from high-cost settings, skilled and committed in-home care workers (home health aides, personal care aides), that work on the “frontlines” of healthcare become even more essential.
- ***Increase Diversity and Cultural Competence:** Increase the cultural, ethnic, and linguistic diversity of licensed health professionals.
As in much of the United States, Rhode Island’s population has grown more diverse culturally, ethnically, and linguistically. The shift to community-based care, the heightened focus on population health, and the need to reduce health disparities strengthen the case for diversity and cultural competency among healthcare providers. To achieve high quality health outcomes for Medicaid beneficiaries across all populations, a professional workforce that speaks the language and has the trust of multiple communities is critical.
- **Develop Youth Initiatives to Expand the Talent Pipeline:** Increase healthcare career awareness, experiential learning opportunities, and readiness for health professional education.
In order to increase the diversity needed in the workforce, and to ensure that there is a workforce that is sufficient in size and capacities in the near future, pipelines bringing youth into the health workforce are vital.
- **Address Provider Shortages:** Remediate shortages among certain health professions.

If there is an undersupply of practitioners that are critical to transforming the RI Medicaid program, the state may realize a significant barrier in achieving changes in delivery and payment. Additionally, as the RI Medicaid program transforms, there are roles or occupations in which shortages will emerge if system-changing practices and supporting arrangements depending on these positions and skill sets are implemented. Addressing provider shortages, both current and anticipated, are needed to drive system transformation.

*This goal and strategies are closely aligned with another DSHP Program, the Wavemaker Fellowship Program. The Wavemaker Fellowship provides loan repayment to college/university graduates who are employed by a Rhode Island employer in the health care, medicine, medical device technology, natural or environmental sciences, computer, information or software technology, advanced mathematics, finance; engineering, industrial or other commercial design fields. Although the Wavemaker Fellowship is open to graduates of many academic disciplines, the Wavemaker Fellowship DSHP is restricted to loan repayment to graduates who work in RI in a health care field at a provider which serves the Medicaid population. Funds from the Wavemaker DSHP will be used to support Workforce Development efforts with a primary focus on recruiting graduates to work in RI by increasing enrollment of entry level health professional graduates into the Wavemaker Program. Additional information about the Wavemaker Fellowship DSHP can be found in Attachment Q.

2. Home and Community-Based Care

Increase the capacity of community-based providers to offer culturally-competent care and services in the home and community and reduce unnecessary utilization of high-cost institutional or specialty care.

Strategies:

- Expand Community-based Health Professional Education: Educate and train health professional students to work in home and community-based settings.

As RI Medicaid begins work to rebalance the delivery system away from high-cost settings, health professional education has been identified as an area of need. There is a growing consensus among the practitioners, policy experts, and educators that candidates for health professions are not fully prepared by their classroom training, residencies, or clinicals for community-based practice. To support the goals of Reinventing Medicaid, it is essential that the state educate and train health professional students to work in home and community-based settings.

- Prepare Healthcare Support Occupations for New and Emerging Roles: Prepare healthcare support occupations to work in home and community-based settings.

Creating a workforce prepared for the shift to home and community-based care goes beyond changes in professional education. It also depends on tapping new roles for existing occupations, as well as for new or emerging occupations.

3. Core Concepts of Health System and Practice Transformation

Increase the capacity of the current and future workforce to understand and apply core concepts of health system and practice transformation.

Strategies:

- Prepare Current and Future Health Professionals to Practice Integrated, Team-Based Care: Increase the capacity of health professionals to integrate physical, behavioral, oral health, and long-term care.

To support RI Medicaid’s goal of providing care that coordinates physical, behavioral, and long-term health care, it is necessary to educate the workforce on practice transformation—teaching team members to work collaboratively, apply metrics to monitor outcomes, and improve workflow, among other skills, to improve the quality of care and patient satisfaction.

- Teach Health System Transformation Core Concepts: Educate the healthcare workforce about the significance of value-based payments, care management, social determinants of health, health equity, population health, and data analytics.
Just as learning the skills of integrated, team-based care is a departure from current health professional education, teaching core concepts of transforming health requires new curricula and new lenses for thinking critically and innovatively about health and healthcare. In order to realize the potential of health systems transformation, the healthcare workforce will require new knowledge as well as renewed skills, including an understanding of the “drivers” of system and practice transformation.

III. Implementation

In June, 2017, EOHHS will convene a HWT Summit which is expected to be attended by over two-hundred (200) healthcare partners. The Summit will feature presentations and workshops that will focus on transformative healthcare workforce innovations from throughout the U.S. and Rhode Island that are related to the priorities and strategies outlined in the HWT Report in support of the Health System Transformation Project. The Summit will also serve to launch the implementation phase of EOHHS’s HWT initiative.

Following the Summit, EOHHS will focus on engaging healthcare educators and healthcare providers to address healthcare workforce transformation priorities and health system transformation goals. The HWT development places particular emphasis on partnerships with the Rhode Island Public Institutions of Higher Education – Rhode Island College, Community College of Rhode Island, and the University of Rhode Island (the “IHEs”) as well as the Accountable Entities in Rhode Island

(AEs) both of which are referenced in the STCs and critical to the State's Health System Transformation Project.

Additionally, EOHHS has structured an IHE Steering Committee under the Interagency Service Agreements with each IHE. The Steering Committee will serve to facilitate the linkage between the:

- a) HWT innovative healthcare workforce development strategies and initiatives identified in the HWT Report;
- b) Parties that are poised with readiness and capabilities to carry out the initiatives; and,
- c) Allocation of the IHE DSHP funding for the efforts to implement the innovative healthcare workforce development programs.

The Interagency Service Agreements (ISAs) with the IHEs provide the structure to link the above: a) planning and strategies; b) capabilities and delivery; and, c) funding. The ISAs include defined templates that require written documentation of the proposed initiative(s) with specific goals and deliverables, a project plan and a budget. The procedures established in the ISAs require these templates be submitted to the Steering Committee when the proposal is first presented, updated during the period of the effort, as warranted, and updated when the effort is complete. The Steering Committee meets at least quarterly, reviews all proposals and vets them against the Health Workforce Transformation Priorities and Strategies, makes recommendations to EOHHS for approval, monitors progress and spending on the initiatives, reviews the deliverables against the proposal and recommends EOHHS disburse funding once the initiative is successfully completed.

The clear strategies and direction of the well-vetted and broadly developed HWT Report - in conjunction with the structure, templates, monitoring, and oversight processes of the Steering Committee (as established by the Interagency Service Agreements) - establish a foundation for the successful implementation of innovative HWT activities to support the HSTP.

Attachment R: Claiming Protocol – Health Workforce Development

Introduction

As described in the Special Terms and Conditions (STCs) of Rhode Island’s Section 1115(a) Demonstration #11-W-00242/1 approved by the Centers for Medicare and Medicaid Services (CMS) on October 20, 2016, the state may claim FFP to solely support the goals of the State’s Health System Transformation Project (HSTP). These STCs provide expenditure authority, which enables Rhode Island to operate its Section 1115 Medicaid Demonstration. Accordingly, Rhode Island established a Designated State Health Program (DSHP) for health workforce training programs and related expenditures to support the program at the University of Rhode Island, Rhode Island College, and the Community College of Rhode Island. This expenditure authority will promote health care objectives that increase efficiency and quality of care through initiatives that transform service delivery networks.

This Health Workforce Development (HWD) DSHP enables Rhode Island (“RI” or “State”) to promote improved access and quality of care for Medicaid beneficiaries in the State by supporting the education and training of the health care workforce which results in employment and/or continuing education of employees in settings that provide care and services to Rhode Island Medicaid beneficiaries.

Through these STCs, CMS also approved and Rhode Island established the following Designated State Health Programs (Program Groups or Program) for which FFP can be claimed:

- Wavemaker Fellowship
- Other DSHPs
 - Tuberculosis Clinic at Miriam Hospital
 - Center for Acute Infectious Disease Epidemiology
 - Rhode Island Child Audiology Center
 - Consumer Assistance Programs
 - Office of the Child Advocate
 - Commission on the Deaf and Hard of Hearing

Through these DSHPs, additional CNOM (Costs Not Otherwise Matchable) activities have been identified for which Federal Financial Participation (FFP) may be claimed. Allowable DSHP claims for each Program are limited to the allowable DSHP costs incurred for the months of the time period defined by the STCs (STC 82).

This document addresses the Health Workforce Development DSHP. The other Program Groups are addressed in separate Protocols. (See Attachment Q for Wavemaker and Attachment P for all other DSHPs.) This document along with Attachments P and Q are attachments to those STCs and contain the protocol for determination of the expenditures eligible for FFP, the claiming and reporting methods and identify the records required to be maintained to support the STCs.

As stated in STC 85, “the annual limit the state may claim FFP for workforce training programs is limited to total costs, in accordance with the OMB Uniform Administrative Requirements, Cost Principles, and Audit Requirements for Federal Awards”. The Office of Management and Budget (OMB) circular effective December 26, 2013, “Uniform Administrative Requirements, Cost Principles, and Audit Requirements for Federal Awards”, defined at 2 CFR 200.402, as amended from time to time (also called “Super-circular”) provides guidance for determining the allowable costs under this protocol.

All claimable DSHP expenditures will be paid from the IHEs general funds up to the amount of the State’s annual appropriation to each IHE which meet CMS’s conditions as eligible state share in claiming FFP. These expenditures will not include expenditures used to meet any federal maintenance of effort requirements nor to provide match for any other federal purpose or grant.

Rhode Island Medicaid will enter into an Interagency Service Agreements (ISA) with each of the three State colleges/universities. Each Agreement will specify what can count as a DSHP expenditure, documentation requirements of the school, and an assurance that the school gives RI Medicaid authority to submit the claim based on their documented, eligible DSHP expenditures. In accordance with the ISA, each state college/university will provide verification that the DSHP eligible expenses are accurate and complete and are based on the instructions provided to each school in this claiming protocol. The IHE will submit expenditures on a quarterly basis (Exhibit B) and provide an "Expenditure Verification" (EV) form (Exhibit A) signed by the appropriate financial officer at the school, e.g., the Chief Financial Officer or Controller. This EV will be submitted to RI EOHHS for review and validation. These expenditure reports will be a part of the quarterly report to CMS.

After review of the EV document and expenditures, EOHHS will submit the claim to CMS for the verified eligible expenditures. In order to provide CMS with timely assurance and support for the DSHP payments, the State will document through a quarterly report to CMS the expenditure detail supporting the request for DSHP payments. EOHHS will report expenditures under the Other/Misc. line for 64 and 37 report purposes, unless otherwise instructed by CMS. Federal funds will be claimed within two years following the calendar quarter in which the state makes expenditures for the HWD DSHP.

2. IHE Expenditures

Per STC # 85, “the state may claim FFP for health workforce training programs and related supports at the University of Rhode Island, Rhode Island College and Community College of Rhode Island.” Each IHE will determine the “Allowable Costs” for each “Allowable (Educational) Program” in each accounting quarter, within the terms defined under the STCs, commencing with date of approval of the STCs, October 20, 2016.

Expenditures for DSHP allowable Health Workforce Development (“HWD”) are defined in the STCs as those incurred by Rhode Island’s three public Institutions of Higher Education including the

University of Rhode Island, Rhode Island College and the Community College of Rhode Island to educate and train health professionals in fields to benefit Medicaid beneficiaries. The focus of the discussion following will be on the identification of allowable expenditures incurred by IHEs in training health care professionals.

Expenditures Claimable for FFP

Expenditures incurred for health workforce training and development activities must be allowable, reasonable and allocable and support the goals of the Rhode Island HSTP initiative.

These expenditures, termed “Allowable Costs”) are made on behalf of qualified individuals who graduate from an “Allowable Program” who work for “qualified employers”, where,

- The healthcare workforce is comprised of “qualified individuals (*students*)” and defined as individuals who:
 - Graduate from an allowable program offered by one of the state’s public higher education institutions;
 - Obtain employment in Rhode Island with one or more “qualifying employers” that provide services to Medicaid enrollees (such as hospitals, nursing homes, health centers, and other participating providers); or
 - Individuals who are currently employed by a “qualifying employer” and who complete a continuing education program provided by the state schools designed to increase the ability of the individual to improve the quality, outcomes, and/or cost effectiveness of care and services to Medicaid enrollees;
- “Allowable Programs” are those Programs (degree, certificate, license academic offerings) that train students for a health care profession, are defined for each IHE; programs will vary by IHE depending upon the IHE’s focus, course, degree and educational offerings and will be collectively determined through discussion and analysis between each IHE and EOHHS. “Allowable Programs” may include but are not limited to the following*:
 - Department of Nursing
 - Department of Pharmacy
 - Health Care Administration
 - Allied Health Programs
 - Dental Health Programs
 - Rehabilitative Health Programs

*The IHEs quarterly expenditure reports will be a part of the quarterly report to CMS and will include the specific programs with the respective CIP Codes listed on each school’s report.

- “Qualified employers” are defined as those employers that are Rhode Island Medicaid providers;
- “Allowable Costs” will include:

- The total costs of qualifying health training program at the three state schools, determined in accordance with the OMB Uniform Administrative Requirements, Cost Principles, and Audit Requirements for Federal Awards” (aka “Super Circular”).
- Adjusted by the “percentage of qualifying students” in each program in the previous year.
- “Total Cost”, defined in the Super-circular, “is the sum of the allowable direct and allocable indirect costs less any applicable credits...such as purchase discounts, rebates or allowances.”
 - “Direct costs” are those costs specifically identified with delivery of a particular objective, in this case, DSHP direct costs are those for delivery of healthcare educational training. DSHP direct costs would include salary and benefits for those who directly deliver the health training programs (e.g., the faculty) and for direct costs necessary to the educational process such as, educational materials, educational subscriptions, guest lecture fees, teaching lab supplies.
 - “Indirect costs” include those costs that are necessary to the educational process and the granting of degrees and certificates but apply to the entire institution that provides the education and training. For purposes of computing “total costs”, each IHE will use the rates approved in their current Indirect Rate Agreement approved by the U. S. Department of Health and Human Services Division of Cost Allocation Services. The rates in these agreements were approved in accordance with the authority of the Office of Management and Budget Circular A-21 (which has been super-ceded by the Super-circular”). The current indirect rate agreements can be found on each IHEs website.

Identification of Allowable Programs

Working in collaboration with the IHE, EOHHS will identify those educational programs that train individuals for a career in the health care professions. Each program will be associated with the **CIP** code for that instructional program as defined by the National Center for Education Statistics Classification of Instructional Programs (**CIP**) which provides a taxonomic scheme that supports the accurate tracking, assessment, and reporting of fields of study and program completions activity. From this taxonomic listing of CIP codes, EOHHS together with the IHEs will identify courses of study that train individuals for a career in the health care professions.

Identification of Allowable Costs

Working in collaboration with EOHHS, the IHE will identify the expenditures associated with those programs of study that meet the requirements for credentials for each of the allowable health care degrees or certificates. The allowable costs will be guided by the standards defined in the OMB’s then current Super-Circular with the IHE’s federally-negotiated and approved indirect rate(s) including on-campus and off-campus rates, as appropriate, utilized to develop Total Costs as defined in #85 of the above referenced STCs.

Determination of Allowable Costs

Each IHE uses an integrated accounting system which classifies expenditures based upon academic departments. Though not all utilize the same system, they accumulate, process, and employ coding structures in similar formats for reporting and audit purposes. The charts of accounts structures have these primary coding structure elements: fund, organization, account, and program. Transactions in

the systems require these coding structures to store, process, and report out expenditures for all programs, including the programs to be claimed under this DSHP.

Through their respective chart of accounts, each IHE records and classifies expenditures for each academic department in the respective accounting systems by functional area. The respective costs of each academic department aggregate to the total costs of the IHEs as presented in their respective Financial Statements.

Additionally, to provide consistency across the IHEs in the determination of Allowable Costs, principles from the National Association of College and University Business Officers (NACUBO) Accounting Principles Council will be utilized in guiding functional reporting of expenses and types of natural expense categories of expense reporting. NACUBO is a membership organization representing more than 2,100 colleges and universities across the country with the mission to advance business practices for higher education institutions. Among the functional reporting categories are: Instructional, Research, Public Service, Academic Support, Student Services Administration, Institutional Support, Operations and Maintenance of Plant, Scholarships and Fellowships, and Auxiliary Operations.

Expenditures to be claimed under this Protocol can be classified as “Instructional” using the NACUBO principles and are included in the respective financial statements of each IHE. The IHE’s financial statements are audited annually and, since each IHE is a component unit of the State of Rhode Island, are included in the State’s Comprehensive Annual Financial Report (CAFR). The IHE will complete the section titled “To be Completed by IHE” on “Allowable Cost Reporting” template at **Exhibit B** of this Attachment for each calendar quarter and will include allowable costs incurred on or after the date of approval of the STCs, October 20, 2016, in accordance with the requirements of this Attachment S.

Reporting of Allowable Costs

Using the IHE’s accounting system, the IHE will identify the allowable costs, as described above by Allowable Program, incurred in a calendar quarter commencing with the date of CMS’ approval of the STCs (October 20, 2016) and will complete and submit the template in **Exhibit B** to EOHHS no later than forty (40) days after the end of each calendar quarter. EOHHS reserves the right to submit DSHP qualifying and allowable expenditures received from an IHE for FFP claiming as long as the expenditures were incurred no more than 2 years prior to the date of FFP claim, in accordance with the federal regulation at 45 CFR Part 95, Subpart A.

Verification of Allowable Costs

Along with the completed Allowable Cost template (**Exhibit B**), the IHE will provide an Expenditure Verification form (EV) (**Exhibit A**) to this Claiming Protocol attesting that the reported expenditures are accurate, are those only for Allowable Programs, include only Allowable Costs and are not used as match or MOE (Maintenance of Effort) for any federal program or grant.

Substantiation of Allowable Costs

For all expenses claimed under this project, the expenses must be auditable and comply with all IHE approval and processing procedures and be properly authorized, documented, and recorded in the respective purchasing, payroll and accounting systems. The IHE will provide reports, procedure

narratives and such other documentation as requested by EOHHS as needed for audit or such other compliance or documentation purposes as arise from time to time.

All labor expenditures must be auditable and be supported by records produced by the IHE’s human resource and payroll systems, e.g., payroll register. All salary and benefit expenditures included in **Exhibit B** will be subject to audit and the IHE will retain sufficient documentation for each expenditure to withstand audit.

Workforce Calculation Methodology

The amount of FFP to be claimed under this protocol is determined by:

- A. Each IHE determining the “Allowable Costs” for each “Allowable (Educational) Program” in each accounting quarter; and,
- B. Adjusted by the “percentage of qualifying students” in each program in the previous year as depicted in the following graphic:

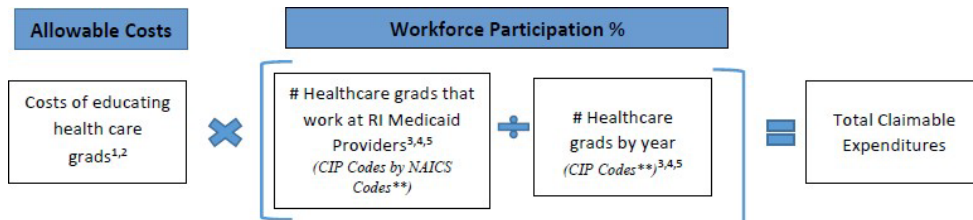

- (1) Expenditures from general ledger with transaction detail
- (2) Wage detail supported by payroll records
- (3) Employment from DLT (RI Dept. Labor & Training), Providence Plan, other external agencies
- (4) Graduates from RI Office of Postsecondary Commissioner, Providence Plan, other
- (5) CIP^{**} codes will be used to match IHE Allowable Programs with those employed in Rhode Island, NAICS^{**} codes will be used to select only those graduates that are employed in a provider that supports Medicaid beneficiaries

^{**} CIP = Classification of Instructional Program
 NAICS = North American Industrial Classification

As in the formula above in “Expenditures Claimable for FFP”, the percent (%) to be applied to Allowable Costs by IHE will be calculated using the percent calculation, shown here and above, and described below.

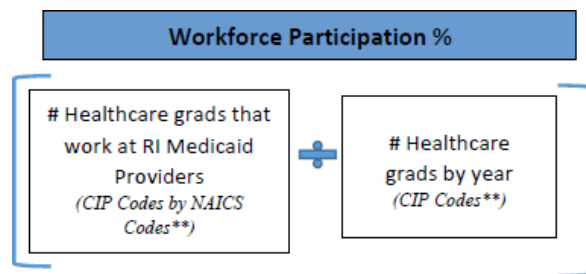

- A. The percent (%) (“Workforce Participation %”) will be determined by matching the:
 - 1. The Numerator = Graduates of an IHE employed by a Rhode Island Medicaid provider as determined from wage records by person by type of Rhode Island employer by health-related NAICS Code (North American Industry Classification System).

The North American Industry Classification System or **NAICS** (pronounced "nakes") is a numbering system (called "NAICS code") that employs a five or six-digit code at the most detailed industry level. EOHHS will review the NAICS classifications and identify those codes that are relevant to health care providers.

Against,

2. The Denominator = Graduates¹ from each IHE trained in a health profession, as determined by CIP Code (**C**lassification of **I**nstructional **P**rograms).

¹Where "graduate" is an employed individual in Rhode Island who graduated from an "allowable health care training program", as defined by allowable CIP codes.

- B. The Workforce Participation % will be calculated utilizing the most recently available graduation and employment data. The lag time for availability of relevant graduation and employment data is approximately one year after the end of the academic year; for example, 2015 data is available in the Summer of 2016; therefore, as an approximation for the 2017 workforce %, the most recently available actual data (2015 for academic year 2017) will be utilized for application to the 2016-2017 academic year costs. Thereafter, the participation % to be applied to the allowable costs will be based on the most recently available actual academic year data.

Workforce Data Source

Both the graduate level data and the employer data will be obtained by EOHHS from agencies which specialize in tracking of labor and employment statistics and include the Rhode Island Office of the Postsecondary Commissioner, the Rhode Island Department of Labor and Training and the Providence Plan (<http://provplan.org/>).

3. Claiming

Upon receipt of **Exhibit A** with the attachment **Exhibit B** from each IHE, EOHHS will review the submission and, as necessary, within 10 business days of receipt raise questions with the IHE for resolution within 10 business days. Once the IHE affirms the submitted costs, EOHHS will apply the Workforce percentage defined in "Workforce Calculation Methodology" above and calculate "Total Claimable Expenditures". EOHHS will then follow their existing procedures for claiming the FFP.

4. Reporting

EOHHS will include claimed DSHP expenditures on the CMS-64 schedule for each quarter. The IHEs quarterly expenditure reports will be a part of the quarterly report to CMS and will include the specific programs with the respective CIP Codes listed on each school's report.

5. Changes to Previously Claimed Amounts

EOHHS shall inform the IHE of any communication and provide the IHE with a copy of any letter or other communication from state or federal officials or staff relating to questions, audits, review, request for information, deferral, recoupment or disallowance of FFP for expenditures certified by the IHE.

The IHE shall inform EOHHS of any communication and provide EOHHS with a copy of any letter or other communication from state or federal officials or staff relating to questions, audits, review, request for information, deferral, recoupment or disallowance of FFP for expenditures certified by the IHE pursuant to this Agreement.

Exhibit A: Expenditure Verification (EV) Form

(See next page for form; MS Word version imbedded here for use)



Exhibit A - VE
draft_03.23.17.docx



Designated State Health Program EXPENDITURE VERIFICATION (EV)

The State of Rhode Island and Providence Plantations Medicaid Agency (EOHHS) requires certain information to enable EOHHS to recognize costs incurred for services rendered for Designated State Health Program (DSHP) as allowable expenditures. The Expenditure Verification (EV) form provides EOHHS with verification of expenditures by Rhode Island’s public Institutions of Higher Education which will allow EOHHS to draw federal matching funds.

This mandatory form will be retained as part of the fiscal documentation for EOHHS.

The completed and signed EV form must be submitted to the attention of the DSHP Project Director by FAX to (401) 462-4652; by email to paul.loberti@ohhs.ri.gov or mailed to:

Paul G. Loberti, MPH
Administrator for Medical Services & DSHP Project Director
RI EOHHS
Hazard Building
74 West Road
Cranston, RI 02920

SECTION I – IHE INFORMATION

Report Period Number	Federal Identification
-------------------------	------------------------

Name and Address – IHE

SECTION II - VERIFICATION

This is to verify that:

- I am authorized to review, sign, and submit this form on behalf of this IHE.
- This IHE expended \$ _____ in general funds for eligible Rhode Island Designated State Health Programs (DSHP), as approved by CMS October 20, 2016 in the 11-W-00242/1 amendment to Rhode Island’s section 1115 Demonstration Waiver. Attached in Exhibit B, is the Allowable Cost report showing the expenditures identified for the approved DSHP program(s).
- The report period submitted is: _____ (mm-dd-yy), through _____ (mm-dd-yy).
- These expenditures do not include costs used to meet federal maintenance of effort requirements nor to provide match for any other federal purpose or grant and do not exceed the State’s annual appropriation.
- Records documenting these expenditures are available for audit by EOHHS.
- I have reviewed the foregoing and verify that the information reported is true and correct to the best of my knowledge and belief.

SECTION III – SIGNATURE

SIGNATURE – Authorized Representative	Date Signed
---------------------------------------	-------------

Name – Authorized Representative (print)
Representative

Telephone Number – Authorized

Title – Authorized Representative
Representative

Email Address – Authorized

Exhibit B: Allowable Cost Reporting

6. Allowable Cost Reporting Template

(See below for example of form; MS Excel version imbedded here for use)



Exhibit B - IHE
Allowable Cost Rep



Health Workforce Development
Allowable Cost Reporting

(a)	(b)	(c)	(d)	(e)	(f)	(g) = (f)*%	(h) = (f)*%	(i) = (g)+(h)	(j) = (e)+(i)
Line #	CIP Ref ²	College	Dept Name ¹	Total Direct Costs ^{2,3}	Indirect Cost Base (i.e., salary and/or fringe cost component of .(e))	Indirect Costs On Campus ⁴ (%)	Indirect Costs Off Campus ⁴ (%)	Total Indirect Costs	Total Costs
						0%	0%		
1		Health Sciences	Psych/CPRC			0.00	0.00	-	-
2		Health Sciences	Psychology			0.00	0.00	-	-
3		Health Sciences	Human Dev/Fam Studies			0.00	0.00	-	-
4		Health Sciences	Communicative Disorders			0.00	0.00	-	-
5		Health Sciences	Physical Therapy			0.00	0.00	-	-
6		Health Sciences	Gerontology			0.00	0.00	-	-
7		Health Sciences	Kinesiology			0.00	0.00	-	-
8		Health Sciences	King, Child Development			0.00	0.00	-	-
9		Health Sciences	Health Studies			0.00	0.00	-	-
10		Health Sciences	Nutrition			0.00	0.00	-	-
11		CEPS	Medical Lab Science			0.00	0.00	-	-
12		Nursing	Nursing Admin			0.00	0.00	-	-
13		Nursing	Nursing Instruction			0.00	0.00	-	-
14		Pharmacy	Pharmacy Dean			0.00	0.00	-	-
15		Pharmacy	Pharmacy Practice			0.00	0.00	-	-
16		Pharmacy	Biomedical and Pharmaceut. Science			0.00	0.00	-	-
Grand Total				-	-	-	-	-	-
BOX A						Work Force Employment in RI⁵			
BOX B						Total Graduates⁵			
BOX C						Work Force Participation % in RI⁵ %			
BOX D						Total Allowable Costs \$			

Footnotes

¹ Department/Program must be matched with one or more CIP codes

² \$'s reported in accordance with guidance of SuperCircular and NACUBO Principles

³ Funding sources as defined

⁴ Federally approved indirect rates

⁵ Data provided by RI Office of the Post-Secondary Commissioner, the Rhode Island Department of Labor and Training and the Providence Plan

7. Instructions for Completing Allowable Cost Reporting Template

Column Ref	Instructions	Responsibility
Column A	This column identifies the line number of the data and is used for reference purposes only. The IHE should add or delete lines as appropriate to the number of Departments listed in Column D.	IHE
Column B	Insert the CIP code in this column that identifies the program of instruction in Column D as classified under the National Center for Education Statistics Classification of Instructional Programs.	IHE
Column C	Insert the name of the Department or College the Allowable educational Program in Column D is offered under.	IHE
Column D	Insert the name of the Allowable educational Program agreed to with EOHHS	IHE
Column E	Insert the total Allowable Costs for the respective Allowable Program.	IHE
Column F	Insert the total Allowable Costs to which the indirect rate is applicable for the respective Allowable Program.	IHE
Column G	Insert the federally approved On-Campus indirect rate in Cell G6. The remainder of Column G will automatically calculate.	IHE
Column H	Insert the federally approved Off-Campus indirect rate in Cell H6. The remainder of Column H will automatically calculate.	IHE
Column I	Column I will automatically populate and total Columns G and H and represents the total of Indirect Costs by Allowable Program.	Calculated
Column J	Column J will automatically populate and total Columns E and I and represents the Total Allowable Costs by Allowable Program.	Calculated

EOHHS will then apply the % of Workforce Participation of Program Graduates by IHE to total Allowable Costs for that IHE as follows (*see “Workforce Calculation Methodology” herein for reference*):

Box A	Populate the number of graduates that obtained relevant employment in Rhode Island with data provided by the external reporting agencies.
Box B	Populate the number of graduates from the IHE with data provided by the external reporting agencies.
Box C	Automatically calculates by dividing Box A by Box B to yield the Workforce Participation %.
Box D	Automatically calculates multiplying total Allowable Costs by Box C the Workforce Participation % and represent the total amount of Allowable Costs that EOHHS will claim for FFP match.

Attachment S: Deliverables Chart – 5 Years

DY	Quality/Operational Improvement Targets	Due Date	% Reduction if State does not meet
DY 11 CY 19	Each MCO with more than 60,000 covered lives has at least 2 effective contracts (or 20% of covered lives) with Certified AEs in an EOHHS approved Alternative Payment Model as defined in Attachment L.	July 1, 2019	10%
	EOHHS Year 3 Guidance Posted, includes: APM Program Guidance, Attribution Guidance, and AE Incentive Program Guidance	December 15, 2019	5%
	Applicable AEs have demonstrated meaningful achievement levels for pre-determined APM payment metrics established in the APM guidance document – Attachment L, for measurement period of July 1, 2018 through June 30, 2019.	December 31, 2019	5%
DY 12 CY 20	Each MCO with at least 60,000 covered lives has at least 3 effective contracts (or 30% of covered lives) with Certified AEs in an EOHHS approved Alternative Payment Model as defined in Attachment L. 10% of covered lives, or at least one contract, shall be through an EOHHS Approved Alternative Payment Methodology that includes shared or full risk.	July 1, 2020	10%
	EOHHS Year 3 Guidance Posted, includes: APM Program Guidance, Attribution Guidance, and AE Incentive Program Guidance	December 15, 2020	5%
	Applicable AEs have demonstrated meaningful achievement levels for pre-determined APM payment metrics established in the APM guidance document – Attachment L, for measurement period of July 1, 2019 through June 30, 2020.	December 31, 2020	5%

Attachment T: RNP Claiming Methodology

Introduction

The Special Terms and Conditions (STCs) of Rhode Island's Section 1115(a) Demonstration #11-W- 00242/1 approved by the Centers for Medicare and Medicaid Services (CMS) on February 8, 2018, include the expenditure authority to Rhode Island (RI) Medicaid for the Recovery Navigation Program (RNP). RNP is a specific set of services that are paid under one bundled rate, to support recovery-oriented environments dedicated to connecting individuals who have a substance use disorder with the necessary level of detox, treatment, and/or recovery services within a less-intensive and less-costly setting of care than is furnished in a hospital setting. Accordingly, Rhode Island Medicaid established the protocols herein to define the claimable RNP expenditures.

Recovery Navigation Program Bundled Rate

Only those facilities that meet the criteria set forth in STC 94 may be reimbursed for RNP services. Below is a description of the services used to develop the rate methodology. A provider may not receive separate reimbursement for an RNP service for the same individual for which an RNP bundled rate was claimed. Medicaid providers delivering other Medicaid-covered services outside of the RNP service bundle may bill in accordance with the state's Medicaid billing procedures. When providing services to individuals with substance use disorders, it may be necessary to provide the service multiple times before treatment is sought, or is successful. Therefore, this bundle may be billed once daily per Medicaid beneficiary with no restriction on the number of times per month, so long as it does not exceed once per day. The following provides a description of how the rate methodology was developed. The methodology reflects an average number of units per day, recognizing that some stays will encompass a higher number of units and some stays will encompass a lower number of units.

The RNP bundled rate that was established by EOHHS is based on the rates paid to providers to deliver similar services on a fee-for-service basis. Rates from the current community mental health centers for case management, and the assessment and monitoring services were utilized to inform the development of this rate. As explained in the chart below, the bundled rate is the sum of each product that resulted from multiplying each component rate by an anticipated average number of units for an RNP participant. When submitting a claim for the RNP bundled rate, providers must include service-level detail to document how many units of each service was delivered to an individual. The claim will be paid at the header level, and shadow billed component services will not receive separate reimbursement and be paid at zero. For a provider to receive the total reimbursement of \$422.50, they must perform a minimum of four (4) 15-minute units of acceptable services during one stay. This process enables EOHHS to monitor the utilization of the services delivered by the RNP. The RNP bundled rate will be reviewed at least annually by CMS for economy and efficiency and recalculated by EOHHS as necessary. The RNP rate does not include costs related to room and board or any other unallowable facility cost, or non-covered Medicaid services.

RNP Rate (Assumes a 4.75 hour encounter)			
Service	Rate/Unit	Average Number of Units	Cost
Assessment and Monitoring	\$22.50/15 minutes	15	\$ 337.50
Case Management	\$21.25/15 minutes	4	\$ 85.00
Total			\$ 422.50

Description of RNP Services

Case Management

Provider Qualifications:

Case management services are provided by a case manager that has a degree in social work, psychology, or other human service related field from an accredited college or university (there is no state level certification or licensure required).

Service Description:

Case management services are limited to identifying, referring, coordinating services and resources for the beneficiary. Referrals to these services may include, but are not limited to, substance use treatment (including medication assisted treatment, detoxification, crisis stabilization, and residential medical services); social services; and housing support services.

Assessment and Monitoring

Provider Qualifications:

A Registered Nurse (RN), Licensed Practical Nurse (LPN), or Emergency Medical Technician (EMT) will provide assessment and monitoring.

Service Description:

Services are inclusive of assessment and clinical monitoring for each individual that accesses the RNP. Observation and clinical information will be reviewed to determine if an individual should be admitted or the level of impairment warrants a transfer to the emergency department (ED). Ongoing assessments include that of vital signs, Blood Alcohol Level (BAL), Clinical Opiate Withdrawal Scale (COWS), and Clinical Institute Withdrawal Assessment (CIWA). The clinical staff will also utilize the Patient Health Questionnaire-9 (PHQ-9) to document any concerns of depression and/or thoughts of self-harm.

Attachment U: RNP Memoranda of Agreements (MOA) Template

Attachment V: RNP Approved EOHHS Screening Tool

ATTACHMENT W

Developing the Evaluation Design

Introduction

For states that are testing new approaches and flexibilities in their Medicaid programs through section 1115 demonstrations, evaluations are crucial to understand and disseminate what is or is not working and why. The evaluations of new initiatives seek to produce new knowledge and direction for programs and inform both Congress and CMS about Medicaid policy for the future. While a narrative about what happened during a demonstration provides important information, the principal focus of the evaluation of a section 1115 demonstration should be obtaining and analyzing data on the process (e.g., whether the demonstration is being implemented as intended), outcomes (e.g., whether the demonstration is having the intended effects on the target population), and impacts of the demonstration (e.g., whether the outcomes observed in the targeted population differ from outcomes in similar populations not affected by the demonstration). Both state and federal governments could benefit from improved quantitative and qualitative evidence to inform policy decisions.

Expectations for Evaluation Designs

All states with Medicaid section 1115 demonstrations are required to conduct an evaluation, and the Evaluation Design is the roadmap for conducting the evaluation. The roadmap begins with the stated goals for the demonstration followed by the measurable evaluation questions and quantifiable hypotheses, all to support a determination of the extent to which the demonstration has achieved its goals.

The format for the Evaluation Design is as follows:

General Background Information;
Evaluation Questions and Hypotheses;
Methodology;
Methodological Limitations;
Attachments.

Submission Timelines

There is a specified timeline for the state's submission of Evaluation Design and Reports. (The graphic below depicts an example of this timeline). In addition, the state should be aware that section 1115 evaluation documents are public records. The state is required to publish the Evaluation Design to the state's website within thirty (30) days of CMS approval, as per 42 CFR 431.424(e). CMS will also publish a copy to the Medicaid.gov website.

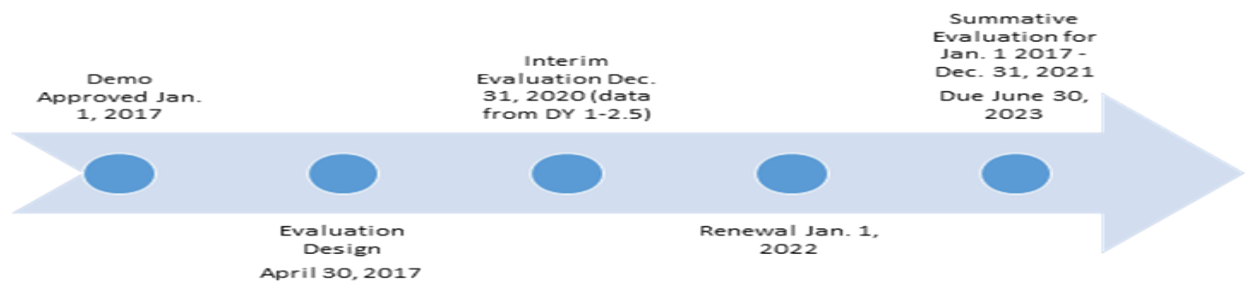

Required Core Components of All Evaluation Designs

The Evaluation Design sets the stage for the Interim and Summative Evaluation Reports. It is important that the Evaluation Design explain the goals and objectives of the demonstration, the hypotheses related to the demonstration, and the methodology (and limitations) for the evaluation. A copy of the state’s Driver Diagram (described in more detail in paragraph B2 below) should be included with an explanation of the depicted information.

A. General Background Information – In this section, the state should include basic information about the demonstration, such as:

- 1) The issue/s that the state is trying to address with its section 1115 demonstration and/or expenditure authorities, the potential magnitude of the issue/s, and why the state selected this course of action to address the issue/s (e.g., a narrative on why the state submitted an 1115 demonstration proposal).
- 2) The name of the demonstration, approval date of the demonstration, and period of time covered by the evaluation;
- 3) A brief description of the demonstration and history of the implementation, and whether the draft Evaluation Design applies to an amendment, extension, renewal, or expansion of, the demonstration;
- 4) For renewals, amendments, and major operational changes: A description of any changes to the demonstration during the approval period; the primary reason or reasons for the change; and how the Evaluation Design was altered or augmented to address these changes.
- 5) Describe the population groups impacted by the demonstration.

B. Evaluation Questions and Hypotheses – In this section, the state should:

- 1) Describe how the state’s demonstration goals are translated into quantifiable targets for improvement, so that the performance of the demonstration in achieving these targets could be measured.

- 2) Include a Driver Diagram to visually aid readers in understanding the rationale behind the cause and effect of the variants behind the demonstration features and intended outcomes. A driver diagram is a particularly effective modeling tool when working to improve health and health care through specific interventions. The diagram includes information about the goal of the demonstration, and the features of the demonstration. A driver diagram depicts the relationship between the aim, the primary drivers that contribute directly to achieving the aim, and the secondary drivers that are necessary to achieve the primary drivers for the demonstration. For an example and more information on driver diagrams:
<https://innovation.cms.gov/files/x/hciatwoaimsdrvrs.pdf>
- 3) Identify the state’s hypotheses about the outcomes of the demonstration:
- 4) Discuss how the evaluation questions align with the hypotheses and the goals of the demonstration;
- 5) Address how the research questions / hypotheses of this demonstration promote the objectives of Titles XIX and/or XXI.

C. Methodology – In this section, the state is to describe in detail the proposed research methodology.

The focus is on showing that the evaluation meets the prevailing standards of scientific and academic rigor, and the results are statistically valid and reliable, and that where appropriate it builds upon other published research (use references).

This section provides the evidence that the demonstration evaluation will use the best available data; reports on, controls for, and makes appropriate adjustments for the limitations of the data and their effects on results; and discusses the generalizability of results. This section should provide enough transparency to explain what will be measured and how. Specifically, this section establishes:

- 1) *Evaluation Design* – Provide information on how the evaluation will be designed. For example, will the evaluation utilize a pre/post comparison? A post-only assessment? Will a comparison group be included?
- 2) *Target and Comparison Populations* – Describe the characteristics of the target and comparison populations, to include the inclusion and exclusion criteria. Include information about the level of analysis (beneficiary, provider, or program level), and if populations will be stratified into subgroups. Additionally, discuss the sampling methodology for the populations, as well as support that a statistically reliable sample size is available.
- 3) *Evaluation Period* – Describe the time periods for which data will be included.

- 4) *Evaluation Measures* – List all measures that will be calculated to evaluate the demonstration. Include the measure stewards (i.e., the organization(s) responsible for the evaluation data elements/sets by “owning”, defining, validating; securing; and submitting for endorsement, etc.) Include numerator and denominator information. Additional items to ensure:
- a. The measures contain assessments of both process and outcomes to evaluate the effects of the demonstration during the period of approval.
 - b. Qualitative analysis methods may be used, and must be described in detail.
 - c. Benchmarking and comparisons to national and state standards, should be used, where appropriate.
 - d. Proposed health measures could include CMS’s Core Set of Health Care Quality Measures for Children in Medicaid and CHIP, Consumer Assessment of Health Care Providers and Systems (CAHPS), the Initial Core Set of Health Care Quality Measures for Medicaid-Eligible Adults and/or measures endorsed by National Quality Forum (NQF).
 - e. Proposed performance metrics can be selected from nationally recognized metrics, for example from sets developed by the Center for Medicare and Medicaid Innovation or for meaningful use under Health Information Technology (HIT).
 - f. Among considerations in selecting the metrics shall be opportunities identified by the state for improving quality of care and health outcomes, and controlling cost of care.
- 5) *Data Sources* – Explain where the data will be obtained, and efforts to validate and clean the data. Discuss the quality and limitations of the data sources.

If primary data (data collected specifically for the evaluation) – The methods by which the data will be collected, the source of the proposed question/responses, the frequency and timing of data collection, and the method of data collection. (Copies of any proposed surveys must be reviewed with CMS for approval before implementation).

- 6) *Analytic Methods* – This section includes the details of the selected quantitative and/or qualitative measures to adequately assess the effectiveness of the demonstration. This section should:
- a. Identify the specific statistical testing which will be undertaken for each measure (e.g., t-tests, chi-square, odds ratio, ANOVA, regression). Table A is an example of how the state might want to articulate the analytic methods for each research question and measure.

- b. Explain how the state will isolate the effects of the demonstration (from other initiatives occurring in the state at the same time) through the use of comparison groups.
 - c. A discussion of how propensity score matching and difference in differences design may be used to adjust for differences in comparison populations over time (if applicable).
 - d. The application of sensitivity analyses, as appropriate, should be considered.
- 7) *Other Additions* – The state may provide any other information pertinent to the Evaluation Design of the demonstration.

Table A. Example Design Table for the Evaluation of the Demonstration

Research Question	Outcome measures used to address the research question	Sample or population subgroups to be compared	Data Sources	Analytic Methods
Hypothesis 1				
Research question 1a	-Measure 1 -Measure 2 -Measure 3	-Sample e.g. All attributed Medicaid beneficiaries -Beneficiaries with diabetes diagnosis	-Medicaid fee-for-service and encounter claims records	-Interrupted time series
Research question 1b	-Measure 1 -Measure 2 -Measure 3 -Measure 4	-sample, e.g., PPS patients who meet survey selection requirements (used services within the last 6 months)	-Patient survey	Descriptive statistics
Hypothesis 2				
Research question 2a	-Measure 1 -Measure 2	-Sample, e.g., PPS administrators	-Key informants	Qualitative analysis of interview material

D Methodological Limitations – This section provides detailed information on the limitations of the evaluation. This could include the design, the data sources or collection process, or analytic methods. The state should also identify any efforts to minimize the limitations. Additionally, this section should include any information about features of the demonstration that effectively present methodological constraints that the state would like CMS to take into consideration in its review. For example:

- 1) When the state demonstration is:
 - a. Long-standing, non-complex, unchanged, or
 - b. Has previously been rigorously evaluated and found to be successful, or

- c. Could now be considered standard Medicaid policy (CMS published regulations or guidance)
- 2) When the demonstration is also considered successful without issues or concerns that would require more regular reporting, such as:
 - a. Operating smoothly without administrative changes; and
 - b. No or minimal appeals and grievances; and
 - c. No state issues with CMS-64 reporting or budget neutrality; and
 - d. No Corrective Action Plans (CAP) for the demonstration.

E. Attachments

- 1) **Independent Evaluator.** This includes a discussion of the state's process for obtaining an independent entity to conduct the evaluation, including a description of the qualifications that the selected entity must possess, and how the state will assure no conflict of interest. Explain how the state will assure that the Independent Evaluator will conduct a fair and impartial evaluation, prepare an objective Evaluation Report, and that there would be no conflict of interest. The evaluation design should include "No Conflict of Interest" signed by the independent evaluator.
- 2) **Evaluation Budget.** A budget for implementing the evaluation shall be provided with the draft Evaluation Design. It will include the total estimated cost, as well as a breakdown of estimated staff, administrative, and other costs for all aspects of the evaluation. Examples include, but are not limited to: the development of all survey and measurement instruments; quantitative and qualitative data collection; data cleaning and analyses; and reports generation. A justification of the costs may be required by CMS if the estimates provided do not appear to sufficiently cover the costs of the draft Evaluation Design or if CMS finds that the draft Evaluation Design is not sufficiently developed.
- 3) **Timeline and Major Milestones.** Describe the timeline for conducting the various evaluation activities, including dates for evaluation-related milestones, including those related to procurement of an outside contractor, if applicable, and deliverables. The Final Evaluation Design shall incorporate an Interim and Summative Evaluation. Pursuant to 42 CFR 431.424(c)(v), this timeline should also include the date by which the Final Summative Evaluation report is due.

ATTACHMENT X

Preparing the Interim and Summative Evaluation Reports

Introduction

For states that are testing new approaches and flexibilities in their Medicaid programs through section 1115 demonstrations, evaluations are crucial to understand and disseminate what is or is not working and why. The evaluations of new initiatives seek to produce new knowledge and direction for programs and inform Medicaid policy for the future. While a narrative about what happened during a demonstration provide important information, the principal focus of the evaluation of a section 1115 demonstration should be obtaining and analyzing data on the process (e.g., whether the demonstration is being implemented as intended), outcomes (e.g., whether the demonstration is having the intended effects on the target population), and impacts of the demonstration (e.g., whether the outcomes observed in the targeted population differ from outcomes in similar populations not affected by the demonstration). Both state and federal governments could benefit from improved quantitative and qualitative evidence to inform policy decisions.

Expectations for Evaluation Reports

Medicaid section 1115 demonstrations are required to conduct an evaluation that is valid (the extent to which the evaluation measures what it is intended to measure), and reliable (the extent to which the evaluation could produce the same results when used repeatedly). To this end, the already approved Evaluation Design is a map that begins with the demonstration goals, then transitions to the evaluation questions, and to the specific hypotheses, which will be used to investigate whether the demonstration has achieved its goals. States should have a well-structured analysis plan for their evaluation. As these valid analyses multiply (by a single state or by multiple states with similar demonstrations) and the data sources improve, the reliability of evaluation findings will be able to shape Medicaid policy in order to improve the health and welfare of Medicaid beneficiaries for decades to come. When submitting an application for renewal, the interim evaluation report should be posted on the state's website with the application for public comment. Additionally, the interim evaluation report must be included in its entirety with the application submitted to CMS.

Intent of this Guidance

The Social Security Act (the Act) requires an evaluation of every section 1115 demonstration. In order to fulfill this requirement, the state's submission must provide a comprehensive written presentation of all key components of the demonstration, and include all required elements specified in the approved Evaluation Design. This Guidance is intended to assist states with organizing the required information in a standardized format and understanding the criteria that CMS will use in reviewing the submitted Interim and Summative Evaluation Reports.

The format for the Interim and Summative Evaluation reports is as follows:

- A. Executive Summary;
- B. General Background Information;
- C. Evaluation Questions and Hypotheses;
- D. Methodology;
- E. Methodological Limitations;
- F. Results;
- G. Conclusions;
- H. Interpretations, and Policy Implications and Interactions with Other State Initiatives;
- I. Lessons Learned and Recommendations; and
- J. Attachment(s).

Submission Timelines

There is a specified timeline for the state's submission of Evaluation Designs and Evaluation Reports. These dates are specified in the demonstration Special Terms and Conditions (STCs). (The graphic below depicts an example of this timeline). In addition, the state should be aware that section 1115 evaluation documents are public records. In order to assure the dissemination of the evaluation findings, lessons learned, and recommendations, the state is required to publish to the state's website the evaluation design within thirty (30) days of CMS approval, and publish reports within thirty (30) days of submission to CMS, pursuant to 42 CFR 431.424. CMS will also publish a copy to Medicaid.gov.

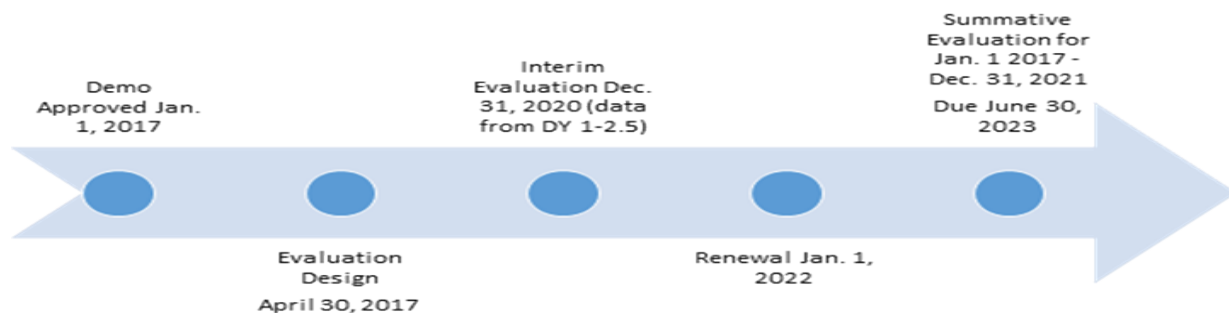

Required Core Components of Interim and Summative Evaluation Reports

The section 1115 Evaluation Report presents the research about the section 1115 Demonstration. It is important that the report incorporate a discussion about the structure of the Evaluation Design to explain the goals and objectives of the demonstration, the hypotheses related to the demonstration, and the methodology for the evaluation. A copy of the state's Driver Diagram (described in the Evaluation Design guidance) must be included with an explanation of the depicted information. The Evaluation Report should present the relevant data and an interpretation of the findings; assess the outcomes (what worked and what did not work); explain the limitations of the design, data, and analyses; offer recommendations regarding what (in hindsight) the state would further advance, or do differently, and why; and discuss the implications on future Medicaid policy. Therefore, the state's submission must include:

- A. Executive Summary** – A summary of the demonstration, the principal results, interpretations, and recommendations of the evaluation.
- B. General Background Information about the Demonstration** – In this section, the state should include basic information about the demonstration, such as:
 - 1) The issues that the state is trying to address with its section 1115 demonstration and/or expenditure authorities, how the state became aware of the issue, the potential magnitude of the issue, and why the state selected this course of action to address the issues.
 - 2) The name of the demonstration, approval date of the demonstration, and period of time covered by the evaluation;
 - 3) A brief description of the demonstration and history of the implementation, and if the evaluation is for an amendment, extension, renewal, or expansion of, the demonstration;
 - 4) For renewals, amendments, and major operational changes: A description of any changes to the demonstration during the approval period; whether the motivation for change was due to political, economic, and fiscal factors at the state and/or federal level; whether the programmatic changes were implemented to improve beneficiary health, provider/health plan performance, or administrative efficiency; and how the Evaluation Design was altered or augmented to address these changes.
 - 5) Describe the population groups impacted by the demonstration.
- C. Evaluation Questions and Hypotheses** – In this section, the state should:
 - 1) Describe how the state's demonstration goals were translated into quantifiable targets for improvement, so that the performance of the demonstration in achieving these targets could be measured. The inclusion of a Driver Diagram in the Evaluation Report is highly encouraged, as the visual can aid readers in understanding the rationale behind the demonstration features and intended outcomes.
 - 2) Identify the state's hypotheses about the outcomes of the demonstration;
 - a. Discuss how the goals of the demonstration align with the evaluation questions

- and hypotheses;
- b. Explain how this Evaluation Report builds upon and expands earlier demonstration evaluation findings (if applicable); and
 - c. Address how the research questions / hypotheses of this demonstration promote the objectives of Titles XIX and XXI.

D. Methodology – In this section, the state is to provide an overview of the research that was conducted to evaluate the section 1115 demonstration consistent with the approved Evaluation Design.

The evaluation design should also be included as an attachment to the report. The focus is on showing that the evaluation builds upon other published research (use references), and meets the prevailing standards of scientific and academic rigor, and the results are statistically valid and reliable.

An interim report should provide any available data to date, including both quantitative and qualitative assessments. The Evaluation Design should assure there is appropriate data development and collection in a timely manner to support developing an interim evaluation.

This section provides the evidence that the demonstration evaluation used the best available data and describes why potential alternative data sources were not used; reported on, controlled for, and made appropriate adjustments for the limitations of the data and their effects on results; and discusses the generalizability of results. This section should provide enough transparency to explain what was measured and how. Specifically, this section establishes that the approved Evaluation Design was followed by describing:

1. *Evaluation Design* – Will the evaluation be an assessment of: pre/post, post-only, with or without comparison groups, etc.?
2. *Target and Comparison Populations* – Describe the target and comparison populations; include inclusion and exclusion criteria.
3. *Evaluation Period* – Describe the time periods for which data will be collected
4. *Evaluation Measures* – What measures are used to evaluate the demonstration, and who are the measure stewards?
5. *Data Sources* – Explain where the data will be obtained, and efforts to validate and clean the data.
6. *Analytic methods* – Identify specific statistical testing which will be undertaken for each measure (t-tests, chi-square, odds ratio, ANOVA, regression, etc.).
7. *Other Additions* – The state may provide any other information pertinent to the evaluation of the demonstration.

A. Methodological Limitations - This section provides sufficient information for discerning the strengths and weaknesses of the study design, data sources/collection, and analyses.

B. Results – In this section, the state presents and uses the quantitative and qualitative data to show to whether and to what degree the evaluation questions and hypotheses of the demonstration were achieved. The findings should visually depict the demonstration results (tables, charts, graphs). This section should include information on the statistical tests conducted.

C. Conclusions – In this section, the state will present the conclusions about the evaluation results.

- 1) In general, did the results show that the demonstration was/was not effective in achieving the goals and objectives established at the beginning of the demonstration?
- 2) Based on the findings, discuss the outcomes and impacts of the demonstration and identify the opportunities for improvements. Specifically:
 - a. If the state did not fully achieve its intended goals, why not? What could be done in the future that would better enable such an effort to more fully achieve those purposes, aims, objectives, and goals?

D. Interpretations, Policy Implications and Interactions with Other State Initiatives – In this section, the state will discuss the section 1115 demonstration within an overall Medicaid context and long range planning. This should include interrelations of the demonstration with other aspects of the state’s Medicaid program, interactions with other Medicaid demonstrations, and other federal awards affecting service delivery, health outcomes and the cost of care under Medicaid. This section provides the state with an opportunity to provide interpretation of the data using evaluative reasoning to make judgments about the demonstration. This section should also include a discussion of the implications of the findings at both the state and national levels.

E. Lessons Learned and Recommendations – This section of the Evaluation Report involves the transfer of knowledge. Specifically, the “opportunities” for future or revised demonstrations to inform Medicaid policymakers, advocates, and stakeholders is just as significant as identifying current successful strategies. Based on the evaluation results:

1. What lessons were learned as a result of the demonstration?
2. What would you recommend to other states which may be interested in implementing a similar approach?

F. Attachment - Evaluation Design: Provide the CMS-approved Evaluation Design

**ATTACHMENT Y:
Evaluation Design**

Evaluation Design Plan

Rhode Island Section 1115 Medicaid Waiver Evaluation

JUNE 25, 2019
Revised on March 9, 2020

PRESENTED TO:
Rebecca Lebeau
State of Rhode Island
Executive Office of Health &
Human Services (EOHHS)
3 West Road
Cranston, RI 02920

PRESENTED BY:
Kristina Hanson Lowell, Project Director
NORC at the University of Chicago
4350 East-West Hwy, Suite 800
Bethesda, MD 20814

Table of Contents

Chapter 1: Introduction	3
Chapter 2: Evaluation Design in Brief.....	6
Chapter 3: Research Domains	16
Chapter 4: Evaluation Measurement Strategies	19
<i>Outcome Measures</i>	19
Chapter 5: Data Sources & Acquisition Plans	24
<i>Claims & Encounter Data Acquisition</i>	24
<i>Non Claims-Based Data Acquisition</i>	25
Chapter 6: Analytic Methods	27
<i>Analytic Methodology for Claims-Based Data</i>	27
<i>Methodological Challenges & Proposed Solutions</i>	32
Chapter 7: Reporting	34
<i>Report Template Development</i>	34
<i>Interim & Summative Evaluation Reports</i>	34
<i>Quarterly & Annual Monitoring Reports</i>	35
Chapter 8: Evaluation Workplan & Budget.....	36
Chapter 9: Staffing & Communication	37
<i>Staffing Plan</i>	37
<i>Communication Plan</i>	37
Appendix A: Draft Evaluation Report Template.....	39
Appendix B: Conflict of Interest Statement.....	42

Table of Exhibits

Exhibit 1:	Key Drivers for the Rhode Island Section 1115 Medicaid Waiver	4
Exhibit 2:	Proposed Evaluation Approach	6
Exhibit 3:	Brief Description of Waiver Programs.....	7
Exhibit 4:	Waiver Program Goals, Performance Metrics, and Target Populations	11
Exhibit 5:	Core Research Domains & Supporting Research Questions	16
Exhibit 6:	Claims-Based Outcome Measures and Specifications	20
Exhibit 7:	Proposed Evaluation Data Sources.....	24
Exhibit 8:	Proposed Data Process Flow	25
Exhibit 9:	Proposed Treatment and Comparison Groups.....	28
Exhibit 10:	Key Evaluation Challenges and Proposed Solutions.....	33
Exhibit 11:	Evaluation Budget	36
Exhibit 12:	NORC Evaluation Team	37

Chapter 1: Introduction

Rhode Island's Section 1115 Demonstration Waiver was initially approved by CMS in 2009 as the *Global Consumer Choice Compact Waiver*. This waiver included all Medicaid populations and provided the state with flexibility in return for accepting a fixed, aggregate spending cap. An extension to the Demonstration was approved in December 2013 to reflect changes to the healthcare landscape stemming from the Patient Protection and Affordable Care Act (ACA) and the implementation of the ACA's Medicaid expansion provision.

Since its inception, the Demonstration has met the goal of improving healthcare access. Per the waiver extension request in December 2008, Rhode Island provided full Medicaid benefits to 171,546 members. By December 2017, that number had increased by 84% to 315,662 members.¹ Medicaid has been crucial to reducing the share of Rhode Island residents without health insurance from 11.6% in 2013 to 4.3% in 2016. Total spending has increased as well, but this increase is due mostly to enrollment growth. Total program spending increased on average by 2.5% per year between 2013 and 2017, but per-member per-month costs (PMPM) decreased by 1.7% per year. Rhode Island's success in keeping its costs low is due largely to a shift from fee-for-service (FFS) to managed care.¹

In July 2018, Rhode Island's Executive Office of Health and Human Services (EOHHS) requested a waiver extension to support and expand its four commitments to improving health and healthcare delivery: 1) pay for value, not volume; 2) coordinate physical, behavioral, and long-term healthcare; 3) rebalance the delivery system away from high-cost settings; and 4) promote efficiency, transparency, and flexibility. Our evaluation will primarily seek to address the impact of the first three of these commitments; the effects on efficiency, transparency, and flexibility will be secondary outcomes that will be indirectly addressed through the evaluation activities. Approved by CMS on December 20, 2018, the extension maintains existing authorities and includes new ones as well. Changes sought in the extension include changes in the areas of eligibility, demonstration benefits, delivery system, and financing:¹

- **Medicaid eligibility** changes will streamline the beneficiary liability collection process, codify the needs-based criteria for service options available to adults with developmental and intellectual disabilities, and create a new eligibility pathway for children with disabilities to receive care in a residential treatment facility.
- **Changes in demonstration benefits** will improve access to a range of programs and cover more services. This evaluation includes the following specific waiver programs:
 - Covering Family Home Visiting Programs to Improve Birth and Early Childhood Outcomes;
 - Supporting Home- and Community-Based Therapeutic Services for the Adult Population;
 - Peer Recovery Specialist (PRS) and Family/Youth Support Partners (FYSP) Programs;
 - Improving Access to Care for Homebound Individuals;

¹ Executive Office of Health and Human Services (EOHHS), State of Rhode Island. The Rhode Island 1115 Waiver Extension Request, July 11, 2018.

- Behavioral Health Link; and
- Modernizing the Preventive and Core Home- and Community-Based Services Benefit Package.
- **Delivery system enhancements** include a Dental Case Management Pilot project, which will involve four new dental case management Current Dental Terminology (CDT) codes for addressing appointment compliance, care coordination, motivational interviewing, and patient education. The pilot will address social determinants of health that affect compliance with appointments and treatment recommendations, improving oral health outcomes, and improving member experience.
- **Demonstration financing** changes include the following: an extension of the Designated State Health Program (DSHP) authority, which funds the Health System Transformation Project (HSTP), through December 31, 2020; and waiving the IMD exclusion to improve access to substance use treatment.

We anticipate that a majority of RI Medicaid enrollees will receive services under one or more programs included in this waiver. HSTP, the broadest program listed here, includes 168,676 attributed lives in AEs (approximately 45% of eligible) as of August 2019; thus, it is likely that some AE enrollees will also receive services under another of the programs included in this evaluation.

The evaluation of this waiver extension covers the three research domains mentioned above. The description of key drivers provided by EOHHS (**Exhibit 1**) outlines the anticipated mechanisms of actions and impact on health outcomes expected as a result of the waiver extension. Anticipated mechanisms of action for “pay for value, not volume” include a transition away from FFS models, Medicaid-wide population health targets tied to payments, and the maintenance and expansion of excellence in program design and outcomes. In order to coordinate physical, behavioral, and long-term healthcare, the extension seeks to maximize enrollment in integrated care delivery systems, implement coordinated accountable care for high-cost/high-need populations, ensure access to high-quality primary care, and leverage health information systems. EOHHS aims to reduce utilization in high-cost settings when avoidable. The waiver accomplishes this by aiming to shift expenditures to community-based settings and encouraging the development of AEs for LTSS. We provide further details in **Exhibit 1** concerning how these anticipated mechanisms of actions may be implemented.

Exhibit 1: Key Drivers for the Rhode Island Section 1115 Medicaid Waiver

Domain	Goal	Strategy
Pay for Value, not Volume	Substantially transition away from FFS models	Increase the percentage of members attributed to AEs
		Create relationships with PCPs and AE members that foster long-term health management within the same setting. This can be tracked through AE attribution tables and through the member satisfaction survey within the Quality Strategy. We can use financial incentives and penalties to increase performance
	Define Medicaid-wide population health targets and, where possible, tie them to payments	Develop clearly defined measures that demonstrate quality of care
	Maintain and expand record of excellence	Develop measures that demonstrate improvement in birth and early childhood outcomes with the addition of the family home visiting program

		Increase the age-out period for kids in Rite Smiles to 21 years of age and continue to monitor the dental health of these members
		Support network adequacy and capacity to meet the needs of Medicaid members by training the healthcare workforce through institutes of higher education to ensure sustainability of the program.
Coordinate, Physical, Behavioral, and Long-Term Healthcare	Maximize enrollment in integrated care delivery systems	Collaborate with local institutions by incentivizing interventions that support the goals of the waiver and participation of AEs through HSTP funding opportunities
	Implement coordinated, accountable care for high-cost/high-need populations	Address gaps in treatment for adults with special healthcare needs by covering home-based therapeutic services, life skills training, and other evidence based practices
	Ensure access to high-quality primary care	Reduce barriers to accessing home-based primary care by reimbursing these services for members who are homebound
	Leverage health information systems to ensure quality, coordinated care	Identify barriers to data sharing, develop mechanisms for clinical data exchange between various EMRs, and support the managed care organization (MCO) with developing an infrastructure to receive data from the AEs
Rebalance the Delivery System Away from High Cost Settings	Shift Medicaid expenditures from high-cost institutional settings to community-based settings	Provide alternatives to emergency departments (EDs) for members experiencing a behavioral health (BH) crisis (e.g., IMDs)
		Expand services to LTSS eligible members to include an array of Home and Community Based Services (HCBS) with an institutional level of care, or those at risk of needing an institutional level of care
		Expand covered services to improve transitions between care settings
		Develop quality measures to determine effectiveness of peer recovery specialists to assist members in navigating the system
	Encourage the development of AEs for integrated LTSS	Explore alternative payment methodologies for home care providers

Chapter 2: Evaluation Design in Brief

We base our evaluation approach on the three research domains that EOHHS has established as priorities for this waiver extension, as articulated in **Exhibit 1**. These include: 1) pay for value, not volume; 2) coordinate physical, behavioral, and long-term healthcare; and 3) rebalance the delivery system away from high-cost settings. These domains guide the framing of the research questions and the selection of data sources, measures, analytic approaches and other aspects of this evaluation design plan. **Exhibit 2** presents our evaluation approach to addressing these three research domains, including data sources, analyses, and categories of key findings.

Exhibit 2: Proposed Evaluation Approach

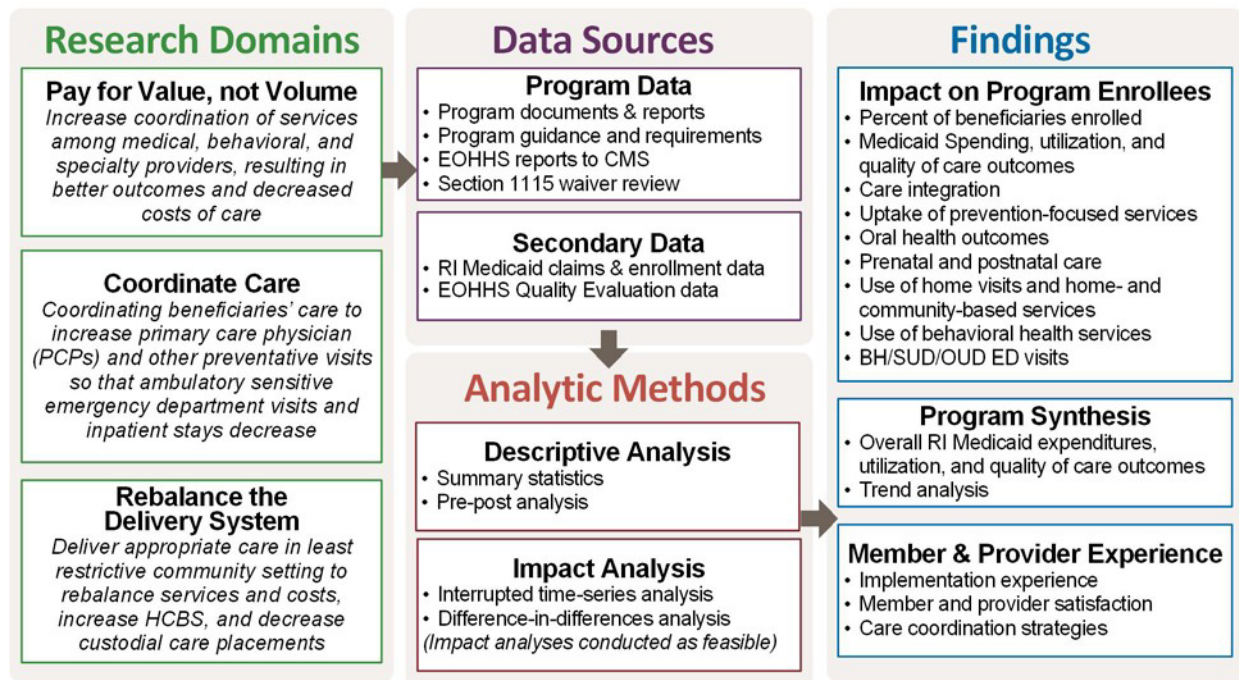

We will use secondary data to fully capture the organizational characteristics of the waiver extension programs, characteristics of beneficiaries served, and the impact on health and quality outcomes. Each year, we will review our data collection tools, sources, and analyses, and update our evaluation approach as necessary to reflect the evolution of these programs as they strive to better serve their populations.

To assess the programs' impact on cost, quality, and utilization, we will use Rhode Island Medicaid claims and encounter data. This includes pre-post analysis and, where possible, interrupted time-series analysis and/or difference-in-differences (DiD) regression analysis. For DiD analyses, we will create appropriate comparison groups and will choose the appropriate model specification based on the observed characteristics and distribution (e.g., proportion of zeros) of each outcome. For multivariate analyses used to estimate the impact of these programs, we will include relevant covariates based on our empirical

model of causality and adjust standard errors to account for clustering of observations to the appropriate unit of analysis.

In addition to the claims-based data, we will be integrating information from the EOHHS Quality Evaluation, which is administering an adapted version of the Clinician and Group Consumer Assessment of Healthcare Providers and Systems (CG-CAHPS) starting in Fall 2020 to measure perceptions of care for AE participants. In addition to the CG-CAHPS, the EOHHS Quality Evaluation will collect and interpret results from CAHPS surveys conducted by participating MCOs annually. We will consider any context and/or outcomes which emerge from the EOHHS Quality Evaluation, and integrate those into our conclusions to the extent possible.

We describe the nine programs included in this evaluation in **Exhibit 3**. While we will use a similar general process to evaluate each of these programs, we will tailor the evaluations to the specific attributes of each program and include additional details on differences in approach in subsequent chapters of this document. We will synthesize findings across programs by analyzing overall trends in Medicaid spending, utilization, and quality of care before and after the waiver implementation dates, which takes into consideration the sum effect of all programs on Rhode Island Medicaid. We will work closely with EOHHS over the course of this contract to update evaluation plans as needed, especially for programs that have not been implemented as of June 2019.

Exhibit 3: Brief Description of Waiver Programs

Program	Summary
<p>Health System Transformation Project (HSTP)</p>	<p>Implementation date: EOHHS provisionally certified six Pilot AEs in late fall of 2015; Program Year One began on July 1, 2018 Anticipated number of recipients: 170,000</p> <p>The Rhode Island HSTP program has been proposed to support the transformation of the Medicaid program. In addition to building from the state's existing infrastructure such as the health information exchange CurrentCare and the All-Payer Claims Database, HSTP aligns its goals and objectives with other transformative initiatives including the Care Transformation Collaborative and the State Innovation Model (SIM). The core component of the HSTP is the creation of Accountable Entities (AEs), integrated provider organizations responsible for the total cost of care, healthcare quality, and outcomes among an attributed population.⁴ The new infrastructure builds on the strengths of the current MCO model to create partnerships between AEs and MCOs.</p> <p>AE attribution is hierarchical. First, eligible AE beneficiaries assigned to a qualified Integrated Health Home (IHH) are attributed to the AE in which the IHH participates. Second, eligible beneficiaries not enrolled in an IHH are attributed to AEs based on each MCO's assignment of PCPs. This assignment is updated quarterly and beneficiaries may be reassigned based on member requests to change PCPs or analyses of utilization patterns. Finally, while MCOs are required to use EOHHS-approved methodology to attribute beneficiaries to AEs, PCP assignment methods vary slightly across MCOs</p> <p>Recognizing that success hinges on having the appropriate workforce in place, HSTP also leverages the state's Health Workforce Transformation (HWT) project, which supports the establishment of AEs and the development of education and training programs to build career pathways to AEs and capacities for AEs.</p>

Program	Summary
Piloting Dental Case Management	<p>Implementation date: February 4, 2019 Anticipated number of recipients: 6 dental practices; 1,375 beneficiaries</p> <p>The Piloting Dental Case Management (CM) program permits six dental practices to participate in a demonstration of the impact of four new dental case management CPT codes. The new codes include addressing appointment compliance barriers, care coordination, motivational interviewing, and patient education to improve oral health literacy. Participating dentists/staff will complete online training modules to give them the skills required to bill for these CM services. The pilot settings include private practice, hospital-based dental clinic, and federally-qualified health centers. Dental care management should improve the social determinants of health that affect compliance, as well as improve member experience, member oral health outcomes, and provider experience (fewer no shows, late appointments, greater chance of improvement to oral health). Vermont, New Jersey, Ohio, Georgia, Indiana, and Minnesota have had positive outcomes with similar dental care management programs.</p>
Covering Family Home Visiting Programs to Improve Birth and Early Childhood Outcomes	<p>Implementation date: July 1, 2020 assuming approval of GR funding Anticipated number of recipients: 1050 families</p> <p>The Covering Family Home Visiting Programs to Improve Birth and Early Childhood Outcomes program targets Medicaid-eligible pregnant individuals and children younger than five years old who are at-risk for adverse health, behavioral, and educational outcomes to be provided evidence-based home visiting services. An evidence-based tool, like the Family/Parent Survey, will be used to identify risk for poor outcomes, and families with multiple risk factors for poor outcomes will be prioritized. The home visits are designed to improve maternal and child health outcomes, encourage positive parenting, and promote child development and school readiness. Rhode Island's home visits are currently implemented through the Nurse-Family Partnership (NFP) and Healthy Families America (HFA) as part of the federal government's Maternal, Infant, and Early Childhood Home Visiting (MIECHV) program.</p>
Supporting Home- and Community-Based Therapeutic Services for the Adult Population	<p>Implementation date: There are no plans to implement this program in the near term, as additional funds are needed to support implementation Anticipated number of recipients: Unknown; TBD when funding is allocated</p> <p>The Supporting Home- and Community-Based Therapeutic Services for the Adult Population program is intended to provide home- and community-based therapeutic services (HBTS) to Medicaid beneficiaries aged 21 or older with at least one of the following: a chronic condition, a behavioral health diagnosis, a neurological diagnosis, or a significant impairment in functioning level determined by a validated screening tool. This program aims to address the treatment gaps that exist due to Rhode Island's fragmented system of population-specific treatment services between child- and adult-eligible services. For instance, some services target only children with special healthcare needs and others only target medically compromised aging populations. Expanding eligibility to include adults will help adults transition from the child system to the adult system. Other possible outcomes from its services may include improvements to the child's ability to succeed without higher level of care, improvement of socially significant behaviors, effective delivery to treatment delivery to individuals recovering from a first episode of psychosis, improved access to treatment and support services for 16 to 25 year-olds at risk of developing a serious mental health condition, and reduced rates of alcohol and drug abuse among youth. At this time, there are no plans to implement this program due to lack of funding.</p>

Program	Summary
Peer Recovery Specialist (PRS) and Family/Youth Support Partners (FYSP) Programs	<p>Implementation date: June 1, 2019 Anticipated number of recipients: 78 families annually</p> <p>The Peer Recovery and Family Youth Support Peer Program will have a Peer Recovery Specialist (PRS) or Family/Youth Partners (FYSP) work with a beneficiary to offer a unique vantage point and the skills of someone who has succeeded in managing a serious behavioral health condition or developmental disability, or is an adult with an on-going and/or personal experience caring for a child or with another family member with a similar mental illness and/or substance use disorder. The key objective of this program is to provide individuals with a support system to develop and learn healthy living skills. The Peer Recovery Specialists (PRS) offer peer services that focus on people with a mental health and/or substance use disorder who are having trouble stabilizing in the community and/or are in need of supports to maintain their stability in the community. This includes but is not limited to Medicaid-eligible individuals who are experiencing, or are at risk of, hospitalization, overdose, homelessness or are in the hospital after an overdose, are homeless or are in a detox setting. It also includes people recently released from institutions such as hospitals and prison. The FYSP offers services to children under 21 years of age and their caregivers related to supporting a child with behavioral health needs and to improve functioning within family and community settings. The services focus on stabilizing the child with behavioral health or developmental disability disorder to promote well-being of the child and limiting the effects of various social determinants. The goal is for the child to continue to be living in the community with services rather than being institutionalized in a short- or long- term residential treatment facility or hospital. Outcomes from this program may include improved socialization, long-term recovery, wellness self-advocacy, connection to the community, as well as treatment of mental health and/or substance use disorders.</p>
Improving Access to Care for Homebound Individuals	<p>Implementation date: No plans to implement in near term Anticipated number of recipients: Unknown; TBD when funding is allocated</p> <p>The Improving Access to Care for Homebound Individuals program will pay for home-based primary care services for Medicaid-eligible individuals who are homebound, have functional limitations that make it difficult to access office-based primary care, or for whom routine office-based primary care is not effective due to their complex medical, social, and/or behavioral health conditions. Home-based primary care has been shown to reduce hospitalizations and nursing facility use, lower healthcare costs, and improve quality of care. It can also increase patient involvement in care and improve patient and family satisfaction. This program aims to increase access and utilization of primary care services by those individuals who are homebound. At this time, there are no plans to implement this program.</p>
Behavioral Health Link (BH Link)	<p>Implementation Date: Opened on November 1, 2018 using existing FFS codes; bundled rate billing began 01/29/2020. Anticipated number of recipients: 3,650 individuals</p> <p>Half of all emergency department visits by RI Medicaid beneficiaries between 2014 and 2016 were related to treatment for mental health conditions. RI developed one Behavioral Health Link (BH Link) triage center to support these patients and all future Medicaid patients that seek crisis stabilization and short-term treatment for behavioral health needs. The triage center currently bills under the FFS payment agreement, but plans to receive a bundled payment per beneficiary per 24-hour window of treatment provided, once approved by CMS. The expected treatments provided include but are not limited to physician services, medication treatment, skilled nursing care, services from mental health professionals, comprehensive assessment and triage, and crisis stabilization.</p>

Program	Summary
<p>Promoting Access to Appropriate, High-Quality Mental Health and Substance Use Treatment by Waiving the Institutions of Mental Disease (IMD) Exclusion</p>	<p>Implementation date: July 1, 2019 Anticipated number of recipients: 7,171 individuals</p> <p>Institutions of Mental Disease (IMDs) are inpatient facilities with more than 16 beds and with 51% of patients having severe mental health condition. Currently, federal financial participation excludes individuals aged 22-64 years old residing in IMDs. This exclusion has caused problems including Medicaid enrollees being treated in hospital emergency departments, which are more expensive and less prepared for mental health/substance abuse; undermining continuity of care efforts; limiting access to substance use treatment programs and constraining Medicaid-funded services and supports; and raising parity issues as a result of the passage of the Mental health Parity and Addiction Equity Act (MHPAEA). This program waives this IMD exclusion for SUD treatment, with the goal of allowing RI to maintain and enhance beneficiary access to behavioral health services in appropriate settings.</p>
<p>Modernizing the Preventive and Core Home- and Community-Based Services Benefit Package</p>	<p>Implementation date: TBD given that new funding is needed Anticipated number of recipients: 5,064 individuals</p> <p>Because of an increase in the aging population and continued increase in total expenses for nursing homes continue to grow in the state, RI seeks to redesign home- and community-based services (HCBS) coverage. The proposed plan included the following four key parts: 1) eliminating selected HCBS that are no longer needed as they are now State Plan benefits, 2) broadening the range of needs-based Preventive and Core HCBS, 3) updating definitions of the existing benefits, and 4) instituting authority to cap the amount or duration of Preventive HCBS based on need and mandating cost-sharing for Preventive HCBS. After review, the proposal was partially approved; no language was added for special terms and conditions (STCs) to institute authority to cap the amount or duration of Preventive HCBS based on need and mandate cost-sharing for Preventive HCBS (proposal #4); furthermore, no authority was granted to provide home stabilization as a Preventive service. or Core service (proposal #2).</p>

SOURCE: Executive Office of Health and Human Services (EOHHS), State of Rhode Island. The Rhode Island 1115 Waiver Extension Request, July 11, 2018; Excel worksheet "1115 Waiver Implementation Dates_NORC" sent by EOHHS to NORC on 5/28/19.

Exhibit 4 presents additional information about the programs included in this evaluation, including program-specific goals, relevant performance metrics, and descriptions of the target population. This information will help shape our selection of evaluation measures and analytic methodology described in the remainder of this evaluation plan. See **Exhibits 5 and 6** for additional information on evaluation hypotheses/research questions and outcome measures, respectively.

Exhibit 4: Waiver Program Goals, Performance Metrics, and Target Populations

Program	Goals	Relevant Performance Metrics	Target Population	Evaluation Hypotheses	Research Questions
Health System Transformation Project (HSTP)	<ul style="list-style-type: none"> ■ Transition the Medicaid payment system away from fee-for-service to alternative payment models ■ Drive delivery system accountability to improve quality, member satisfaction and health outcomes, while reducing cost of care ■ Develop targeted provider partnerships that apply emerging data capabilities to refine and enhance care management, pathways, coordination, and timely responsiveness to emergent needs ■ Improve health equity and address Social Determinants of Health (SDOH) and Behavioral Health (BH) by building on a strong primary care foundation to develop interdisciplinary care capacity that extends beyond traditional health care providers ■ Enable vulnerable populations to live successfully in the community 	<ul style="list-style-type: none"> ■ All-cause readmissions ■ ED utilization among members with mental illness ■ Potentially avoidable ED visits ■ Breast cancer screening ■ Follow-up after hospitalization for mental illness ■ CG-CAHPS and CAHPS outcomes 	<ul style="list-style-type: none"> ■ The population eligible for attribution to an AE consists of Medicaid-only beneficiaries enrolled in managed care, and beneficiaries may only be attributed to a single AE. ■ An attribution-eligible provider can only participate in one AE at a time for the purposes of attribution. ■ PCP assignment methods vary slightly across MCOs. 	<ul style="list-style-type: none"> ■ The demonstration will reduce utilization and overall Medicaid spending while maintaining quality of care for RI Medicaid enrollees ■ The demonstration will increase coordination among different care types, leading to better health outcomes for RI Medicaid enrollees 	<ul style="list-style-type: none"> ■ What percentage of RI Medicaid patients are attributed to this waiver program? ■ What are the trends in spending, utilization, and quality of care? ■ What is the impact on spending, utilization, and quality of care for AE-attributed members? ■ What is the experience of care for AE-attributed members? Are they satisfied with their care? ■ Does better care integration reduce high-cost care for enrollees?
Piloting Dental Case Management	<ul style="list-style-type: none"> ■ Increase use of preventive services ■ Decrease broken appointments ■ Improve the social determinants of health that affect compliance, member experience, health outcomes, and provider experience 	<ul style="list-style-type: none"> ■ Frequency of use of new dental case management codes at the participating dental practices ■ Rate of broken appointments 	<ul style="list-style-type: none"> ■ RI Medicaid enrollees ages 18 and over in the traditional fee-for-service dental delivery system, seen at participating dental practices 	<ul style="list-style-type: none"> ■ The demonstration will reduce utilization and overall Medicaid spending while maintaining quality of care for RI Medicaid enrollees ■ The demonstration will increase coordination among different care types, leading to better health outcomes for RI Medicaid enrollees 	<ul style="list-style-type: none"> ■ What percentage of RI Medicaid patients are attributed to this waiver program? ■ What are the trends in spending, utilization, and quality of care? ■ Does the demonstration increase uptake of prevention-focused resources into routine medical care for high-cost/high-need RI Medicaid enrollees?

Program	Goals	Relevant Performance Metrics	Target Population	Evaluation Hypotheses	Research Questions
Covering Family Home Visiting Programs to Improve Birth and Early Childhood Outcomes	<ul style="list-style-type: none"> ■ Improve maternal and child health outcomes ■ Encourage positive parenting ■ Promote child development and school readiness 	<ul style="list-style-type: none"> ■ Well child visits ■ Childhood vaccinations ■ Timeliness of prenatal care ■ Postnatal care 	<ul style="list-style-type: none"> ■ RI Medicaid-eligible pregnant individuals and children up to age four; at-risk for adverse health, behavioral, and educational outcomes (families with multiple risk factors will be prioritized) 	<ul style="list-style-type: none"> ■ The demonstration will reduce utilization and overall Medicaid spending while maintaining quality of care for RI Medicaid enrollees ■ The demonstration will increase coordination among different care types, leading to better health outcomes for RI Medicaid enrollees 	<ul style="list-style-type: none"> ■ What percentage of RI Medicaid patients are attributed to this waiver program? ■ What are the trends in spending, utilization, and quality of care? ■ Does the demonstration increase uptake of prevention-focused resources into routine medical care for high-cost/high-need RI Medicaid enrollees? ■ Does increasing access to home visits impact maternal and child health outcomes?
Supporting Home- and Community-Based Therapeutic Services for the Adult Population	<ul style="list-style-type: none"> ■ Help adults transition from the child HBTS program ■ Improvements in ability to succeed without higher-level care, socially significant behaviors ■ Improved access to treatment and support services ■ Reduced rates of alcohol and drug abuse 	<ul style="list-style-type: none"> ■ Use of HBTS services ■ Use and types of HBCS services ■ Rates of institutionalization 	<ul style="list-style-type: none"> ■ RI Medicaid enrollees at least 21 years old who have a diagnosis of a chronic condition such as arthritis, asthma, diabetes, heart disease; special needs/diseases; a BH diagnosis; a neurological diagnosis; or significant impairment in functioning level as determined by a validated screening tool. 	<ul style="list-style-type: none"> ■ The demonstration will reduce utilization and overall Medicaid spending while maintaining quality of care for RI Medicaid enrollees ■ The demonstration will shift care away from high-cost settings (e.g., the ED), reducing spending while increasing utilization in lower-cost settings. 	<ul style="list-style-type: none"> ■ What percentage of RI Medicaid patients are attributed to this waiver program? ■ What are the trends in spending, utilization, and quality of care? ■ Has the expansion of covered home- and community-based services impacted rates of institutionalization and/or home-based care?

Program	Goals	Relevant Performance Metrics	Target Population	Evaluation Hypotheses	Research Questions
Peer Recovery Specialist (PRS) and Family/Youth Support Partners (FYSP) Programs	<ul style="list-style-type: none"> ■ To provide peer-to-peer mentoring supports that go beyond recovery navigation ■ Provide individuals with a support system to develop and learn healthy living skills. ■ Teaching families the skills necessary to improve coping abilities and positive parenting skills ■ Developing and linking children, youth and parents/caregiver with formal and informal support ■ Helping families to secure basic needs, and access health insurance or social service benefits ■ Improving socialization, long-term recovery, self-advocacy, connection to the community, and treatment of mental health and/or substance use disorders 	<ul style="list-style-type: none"> ■ Access to physical health care ■ Use of BH services ■ BH-related ED visits ■ Follow-up after ED visit for mental illness ■ IMD use 	<ul style="list-style-type: none"> ■ PRS: Medicaid-eligible individuals experiencing or at risk of, hospitalization, overdose, homelessness or are in the hospital after an overdose, are homeless or are in a detox setting, or recently released from institutions such as hospitals and prison. ■ FYSP: Parents and youth covered by RI Medicaid with complex behavioral health needs who are at risk of having to leave the home due to child welfare or juvenile justice involvement, or may need extended residential psychiatric treatment 	<ul style="list-style-type: none"> ■ The demonstration will reduce utilization and overall Medicaid spending while maintaining quality of care for RI Medicaid enrollees ■ The demonstration will increase coordination among different care types, leading to better health outcomes for RI Medicaid enrollees ■ The demonstration will shift care away from high-cost settings (e.g., the ED), reducing spending while increasing utilization in lower-cost settings. 	<ul style="list-style-type: none"> ■ What percentage of RI Medicaid patients are attributed to this waiver program? ■ What are the trends in spending, utilization, and quality of care? ■ To what extent has the demonstrations integrated BH and SUD care into medical care? How has this affected health outcomes and BH/SUD treatment uptake for RI Medicaid enrollees? ■ What are the trends in ED visits and IMD use for members accessing behavioral health services?
Improving Access to Care for Homebound Individuals	<ul style="list-style-type: none"> ■ Increase access and utilization of primary care services by homebound individuals 	<ul style="list-style-type: none"> ■ Primary care visits ■ Primary care home visits ■ ED use 	<ul style="list-style-type: none"> ■ RI Medicaid enrollees who are homebound, have functional limitations, or for whom office-based primary care isn't effective because of complex medical, social, and/or BH conditions 	<ul style="list-style-type: none"> ■ The demonstration will reduce utilization and overall Medicaid spending while maintaining quality of care for RI Medicaid enrollees ■ The demonstration will shift care away from high-cost settings (e.g., the ED), reducing spending while increasing utilization in lower-cost settings. 	<ul style="list-style-type: none"> ■ What percentage of RI Medicaid patients are attributed to this waiver program? ■ What are the trends in spending, utilization, and quality of care? ■ Has the expansion of covered home- and community-based services impacted rates of institutionalization and/or home-based care?

Program	Goals	Relevant Performance Metrics	Target Population	Evaluation Hypotheses	Research Questions
Behavioral Health Link	<ul style="list-style-type: none"> ■ Move to billing bundled rate for BH Link services on a per-beneficiary basis 	<ul style="list-style-type: none"> ■ Access to physical health care ■ Use of BH services ■ BH-related ED visits ■ Follow-up after ED visit for mental illness ■ IMD use 	<ul style="list-style-type: none"> ■ RI Medicaid enrollees who are in crisis due to substance use disorders, mental health disorders or co-occurring mental health and substance use disorders 	<ul style="list-style-type: none"> ■ The demonstration will reduce utilization and overall Medicaid spending while maintaining quality of care for RI Medicaid enrollees ■ The demonstration will increase coordination among different care types, leading to better health outcomes for RI Medicaid enrollees ■ The demonstration will shift care away from high-cost settings (e.g., the ED), reducing spending while increasing utilization in lower-cost settings. 	<ul style="list-style-type: none"> ■ What percentage of RI Medicaid patients are attributed to this waiver program? ■ What are the trends in spending, utilization, and quality of care? ■ To what extent has the demonstrations integrated BH and SUD care into medical care? How has this affected health outcomes and BH/SUD treatment uptake for RI Medicaid enrollees? ■ What are the trends in ED visits and IMD use for members accessing behavioral health services?
Promoting Access to Appropriate, High-Quality Mental Health and Substance Use Treatment by Waiving the Institutions of Mental Disease (IMD) Exclusion	<ul style="list-style-type: none"> ■ Allow RI to maintain and enhance beneficiary access to behavioral health services in appropriate settings 	<ul style="list-style-type: none"> ■ IMD use ■ Use of BH services ■ SUD/ODU-related ED visits ■ Receipt of care following referral for SUD/ODU ■ Rate of overdose deaths 	<ul style="list-style-type: none"> ■ RI Medicaid enrollees aged 21 to 64 years with mental health or substance use disorders and a clinical need for residential treatment and the services and supports required to make a transition back into the community 	<ul style="list-style-type: none"> ■ The demonstration will reduce utilization and overall Medicaid spending while maintaining quality of care for RI Medicaid enrollees ■ The demonstration will shift care away from high-cost settings (e.g., the ED), reducing spending while increasing utilization in lower-cost settings. 	<ul style="list-style-type: none"> ■ What percentage of RI Medicaid patients are attributed to this waiver program? ■ What are the trends in spending, utilization, and quality of care? ■ What are the trends in ED visits and IMD use for members accessing behavioral health services?

Program	Goals	Relevant Performance Metrics	Target Population	Evaluation Hypotheses	Research Questions
Modernizing the Preventive and Core Home- and Community-Based Services Benefit Package	<ul style="list-style-type: none"> ■ Eliminate select HCBS that are no longer needed as they are now State Plan benefits ■ Update the definitions of HCBS benefits 	<ul style="list-style-type: none"> ■ Use of HCBS services ■ Minimizing institutional length of stay ■ Successful transition after institutionalization 	<ul style="list-style-type: none"> ■ RI Medicaid enrollees eligible based on age, disability or blindness who meet the applicable clinical/functional criteria 	<ul style="list-style-type: none"> ■ The demonstration will reduce utilization and overall Medicaid spending while maintaining quality of care for RI Medicaid enrollees ■ The demonstration will increase coordination among different care types, leading to better health outcomes for RI Medicaid enrollees ■ The demonstration will shift care away from high-cost settings (e.g., the ED), reducing spending while increasing utilization in lower-cost settings. 	<ul style="list-style-type: none"> ■ What percentage of RI Medicaid patients are attributed to this waiver program? ■ What are the trends in spending, utilization, and quality of care? ■ Does the demonstration increase uptake of prevention-focused resources into routine medical care for high-cost/high-need RI Medicaid enrollees? ■ Has the expansion of covered home- and community-based services impacted rates of institutionalization and/or home-based care?

NOTE: Bolded program goals will be addressed in this claims-based evaluation.

Chapter 3: Research Domains

NORC’s evaluation of this waiver extension will address the success of each program based on its impact on care coordination, health care utilization, spending, quality of care and, ultimately, health outcomes. We will use the following three research domains to guide our evaluation:

- Pay for value, not volume;
- Coordinate physical, behavioral, and long-term care; and
- Rebalance the delivery system away from high-cost settings

As mentioned previously, we will also indirectly addressing the state’s goal to promote efficiency, transparency, and flexibility through the three domains above. Using Rhode Island Medicaid claims and encounter data, we will address research questions included under the three domains listed above. **Exhibit 5** lists the demonstration goals, evaluation hypotheses, and research questions for this evaluation. See **Exhibits 4 and 6** for additional information on program goals and outcome measures, respectively.

Exhibit 5: Core Research Domains & Supporting Research Questions

Research Question	Relevant Programs	Outcome Measures	Data Sources			Analytic Methods
			Demonstration Documents & Data	Medicaid Claims & Encounter Data	EOHHS Quality Evaluation Data	
<i>Demonstration Goal #1: Pay for value, not volume</i>						
<i>Evaluation Hypothesis: The demonstration will reduce utilization and overall Medicaid spending while maintaining quality of care for RI Medicaid enrollees</i>						
1	<ul style="list-style-type: none"> ■ All programs 	<ul style="list-style-type: none"> ■ Percent of RI Medicaid members enrolled 	■	■		<ul style="list-style-type: none"> ■ Descriptive analysis
2	<ul style="list-style-type: none"> ■ All programs 	<ul style="list-style-type: none"> ■ Total Medicaid spending ■ Hospitalizations, Readmissions ■ ED Visits 		■		<ul style="list-style-type: none"> ■ Descriptive analysis ■ Interrupted time-series if feasible; otherwise pre-post

3	What are the trends in spending, utilization, and quality of care in the entire RI Medicaid population?	<ul style="list-style-type: none"> All programs (synthesized findings) 	<ul style="list-style-type: none"> Total Medicaid Spending Total SUD-related Medicaid spending² Hospitalizations, Readmissions ED Visits AE performance metrics 		■		<ul style="list-style-type: none"> Descriptive analysis Interrupted time-series if feasible; otherwise pre-post
4	What is the impact on spending, utilization, and quality of care for AE-attributed members?	<ul style="list-style-type: none"> HSTP 	<ul style="list-style-type: none"> Spending, utilization, and quality measures 		■		<ul style="list-style-type: none"> Descriptive analysis Difference-in-differences
5	What is the experience of care for AE-attributed members? Are they satisfied with their care?	<ul style="list-style-type: none"> HSTP 	<ul style="list-style-type: none"> CG-CAHPS and CAPHs measures 			■	<ul style="list-style-type: none"> Descriptive analysis
<i>Demonstration Goal #2: Coordinate physical, behavioral, and long-term care</i>							
<i>Evaluation Hypothesis: The demonstration will increase coordination among different care types, leading to better health outcomes for RI Medicaid enrollees</i>							
6	Does better care integration reduce high-cost care for enrollees?	<ul style="list-style-type: none"> HSTP 	<ul style="list-style-type: none"> Potentially avoidable ED use ED use among members with mental illness CG-CAHPS and CAPHs measures 	■		■	<ul style="list-style-type: none"> Descriptive analysis Difference-in-differences
7	To what extent has the demonstrations integrated BH and SUD care into medical care? How has this affected health outcomes and BH/SUD treatment uptake for RI Medicaid enrollees?	<ul style="list-style-type: none"> PRS/FYSP 	<ul style="list-style-type: none"> Access to physical health care Use of BH services BH/SUD/OD ED visits Follow-up after ED visit for mental illness Follow-up after SUD/OD referral 		■		<ul style="list-style-type: none"> Descriptive analysis Interrupted time-series if feasible; otherwise pre-post
		<ul style="list-style-type: none"> Building BH Supports 					
8	Does the demonstration increase uptake of prevention-focused resources into routine medical care for high-cost/high-need RI Medicaid enrollees?	<ul style="list-style-type: none"> Dental Case Management 	<ul style="list-style-type: none"> Frequency of dental case management code usage Dental services & oral health events 		■		<ul style="list-style-type: none"> Descriptive analysis Interrupted time-series if feasible; otherwise pre-post
		<ul style="list-style-type: none"> Family Home Visits 	<ul style="list-style-type: none"> Well child visits Childhood immunization 				
		<ul style="list-style-type: none"> Modernizing HCBS 	<ul style="list-style-type: none"> Use of covered preventive services 				
9	Does increasing access to home visits impact maternal and child health outcomes?	<ul style="list-style-type: none"> Family Home Visits 	<ul style="list-style-type: none"> Timeliness of prenatal care Postpartum care 		■		<ul style="list-style-type: none"> Descriptive analysis Interrupted time-series if feasible; otherwise pre-post
<i>Demonstration Goal #3: Rebalance the delivery system away from high-cost settings</i>							
<i>Evaluation Hypothesis: The demonstration will shift care away from high-cost settings (e.g., the ED), reducing spending while increasing utilization in lower-cost settings.</i>							
10	What are the trends in ED visits and IMD use for members accessing behavioral health services?	<ul style="list-style-type: none"> IMD Exclusion 	<ul style="list-style-type: none"> IMD use Use of BH services BH/SUD/OD ED visits Rate of overdose deaths 		■		<ul style="list-style-type: none"> Descriptive analysis Interrupted time-series if feasible; otherwise pre-post
		<ul style="list-style-type: none"> PRS/FYSP 					
		<ul style="list-style-type: none"> Building BH Supports 					
11		<ul style="list-style-type: none"> Modernizing HCBS 	<ul style="list-style-type: none"> Use of HCBS services Institutional length of stay 		■		<ul style="list-style-type: none"> Descriptive analysis

² As defined in CMS’ “[SMI/SED and SUD Evaluation Design Guidance: Appendix C](#),” SUD-related spending includes SUD-IMD costs, other SUD costs, and non-SUD costs.

	Has the expansion of covered home- and community-based services impacted rates of institutionalization and/or home-based care?		<ul style="list-style-type: none"> ■ Successful transition after institutionalization 			<ul style="list-style-type: none"> ■ Interrupted time-series if feasible; otherwise pre-post
		<ul style="list-style-type: none"> ■ Supporting HBTS 	<ul style="list-style-type: none"> ■ Use of HBTS services ■ Use of HCBS services ■ Institutionalization 			
		<ul style="list-style-type: none"> ■ Access for Homebound Enrollees 	<ul style="list-style-type: none"> ■ Primary care visits ■ Home-based primary care visits ■ ED use among homebound patients 			

Chapter 4: Evaluation Measurement Strategies

This chapter presents the measures that will serve as variables in this evaluation, including outcomes and covariates that will be used to estimate impact. The development of measures is an iterative process expected to be refined over the course of the evaluation. We expect that, as we learn more about these programs and their implementation, we will provide a more clearly defined, parsimonious, set of variables based on how measures are operationalized in the evaluation.

Outcome Measures

Using Rhode Island Medicaid claims, we will construct a number of measures to assess the waiver's impact on cost, utilization, and quality of care outcomes for the program populations and, as possible, for key subpopulations. Successful construction of these measures will be dependent on data quality and availability; we will work with EOHHS to create a final list of outcome measures after conducting a data quality assessment. The list of proposed measures will be refined periodically, with guidance from EOHHS and informed by the evaluation work underway.

Our claims-based outcomes are derived from Rhode Island Medicaid claims shared by EOHHS. We will present a standard set of six core measures for each program, as well as additional program-specific measures as data and resources allow. A list of proposed secondary data outcome measures are displayed in **Exhibit 6**, as well as their working definitions. All measures will be assessed annually and will be included in both the interim and summative evaluation reports. Where possible, evaluation results will incorporate national or state-defined standards and/or benchmarks for comparison purposes. These may include comparison data from the Child and Adult Core Set measures³ or historical in-state benchmarks using Rhode Island Medicaid claims and encounter data. See **Exhibits 4 and 5** for additional information on program goals and evaluation hypotheses/research questions, respectively.

Our evaluation will also integrate two non-claims data sources. First, we will review 1115 Medicaid program documents and data to explore process measures and implementation experience of each of the programs; this may also include program-derived quality and/or health outcome measures (e.g., quality metrics calculated by MCOs for HSTP, behavioral health data from the Department of Behavioral Healthcare, Developmental Disabilities, and Hospitals (BHDDH)). We plan to review these documents as they are submitted but at least annually, as we understand that these programs may change over time. Second, we will be receiving data from the EOHHS Quality Evaluation, which integrates CG-CAHPS and the CAHPS administered by MCOs; these data will provide context on patient experience and satisfaction for HSTP. We will work closely with EOHHS and the Quality Evaluation team to gain access to the relevant data in an agreeable form and contextualize and expand upon any observed claims-based findings.

³ CMS releases information annually on state progress in reporting the Adult Core Set measures and assesses state-specific performance for measures that are reported by at least 25 states and which met internal standards of data quality.

Exhibit 6: Claims-Based Outcome Measures and Specifications

Measure	Definition	Steward	Numerator	Denominator	RQ #
All Programs					
Percent of members enrolled	Percentage of members enrolled and/or engaged in each of the waiver programs (definition of enrolled will vary by program criteria)	N/A	Members enrolled and/or engaged in each waiver program	Total number of RI Medicaid enrollees	1
Total Medicaid spending	Total Medicaid expenditures per enrollee per year. Include all Medicaid costs on all claims and encounter data through attribution end date.	N/A	Total Medicaid expenditures in reporting year	Number of beneficiaries per reporting year	2, 3, 4
Hospitalizations	Number of all-cause acute care inpatient stays per enrollee per year, calculated as the total count of inpatient stays per year. In case a hospital to hospital transfer occurs, only one stay is counted.	N/A	All-cause acute care inpatient stays	All-cause acute care inpatient stays	2, 3, 4
Annual wellness visit	Number of continuously enrolled (9 out of 12 months) members who have had at least 1 wellness visit with a provider within the span of the year	N/A	Members with at least 1 wellness visit with a provider in year	All continuously enrolled members	2, 3, 4
ED visits	Number of ED visits and observation stays per enrollee per year not resulting in a short-term inpatient hospitalization. ED admit date needs to fall within the performance or base year.	N/A	ED visits and observation stays not resulting in a short-term inpatient hospitalization	All ED visits and observation stays	2, 3, 4
All-cause readmissions	Occurrences of unplanned hospitalization within 30 days of discharge from hospital (index hospitalization denominator) per beneficiary per year. This analysis will be done for only members with an index hospitalization, as those without an index hospitalization cannot subsequently have a 30-day readmission.	NCQA	Unplanned hospitalizations within 30 days of discharge from index hospitalization	Index hospitalizations in reporting year	2, 3, 4
Health System Transformation Project					
Mental illness ED utilization	Rate of ED utilization among enrollees with a mental illness diagnosis	OHA ⁴	Number of ED visits among RI Medicaid enrollees with a mental illness diagnosis	Number of enrollee-months for RI Medicaid enrollees aged 18 years and over with a mental illness diagnosis	6
Potentially avoidable ED visits	Rate of potentially avoidable ED visits per the NYU algorithm	NYU ⁵	Number of ED visits deemed preventable	Number of ED visits for RI Medicaid enrollees, excluding those who were subsequently admitted	6
Breast cancer screening	Percentage of women 50-74 years of age who had a mammogram to screen for breast cancer	NQF #2372	Number of women who received a mammogram to screen for breast cancer	Number of women 50-74 years of age	3

⁴ Source: <https://www.oregon.gov/oha/HPA/dsi-tc/Resources/10-10-18%20ED-Mental%20Illness%20Webinar%20Slides.pdf>

⁵ Gandhi SO, Sabik S. Emergency department visit classification using the NYU algorithm. *Am J Manag Care* 2014; 20(4): 315-320.

Measure	Definition	Steward	Numerator	Denominator	RQ #
Follow-up after hospitalization for mental illness	Percentage of patients who were hospitalized with selected illness diagnoses and who had a follow-up visit with a mental health provider reported within 30 days and 7 days	NQF #0576	Number of discharges with a follow-up visit with a mental health practitioner within 30 or 7 days after discharge	Number of discharges from an acute inpatient setting with a principal diagnosis of mental illness during the first 11 months of the year	3
Piloting Dental Case Management					
Dental codes	Frequency of use of new dental case management codes (D9991, D9992, D9993, D9994) in claims in up to six qualified dental practices	N/A	Number of dental claims for RI Medicaid enrollees that include new dental case management codes	Total number of dental claims for RI Medicaid enrollees	8
Dental services	Percentage of enrolled members who received at least one dental service within the reporting year	NQF #2511	Number of RI Medicaid enrollees who received at least one dental service	Number of RI Medicaid enrollees with dental coverage	8
Oral health events	Rate of oral health events (e.g., number of dental conditions, fillings, extractions, etc.) annually	N/A	Number of RI Medicaid enrollees with an identified oral health event	Number of RI Medicaid enrollees with dental coverage	8
Covering Family Home Visiting Programs to Improve Birth and Early Childhood Outcomes					
Well child visits	Percentage of children 15 months old who had well-child visits with a primary care physician during the measurement year	NQF #1392	RI Medicaid enrollees who received six or more well-child visits with a PCP during their first 15 months of life	RI Medicaid enrollees who turn 15 months old during the year	8
Timeliness of prenatal care	The percentage of deliveries that received a prenatal care visit as a member of the organization in the first trimester or within 42 days of enrollment in the organization	NQF #1517	Number of live births among RI Medicaid enrollees for which the mother received a prenatal care visit	Number of live births among RI Medicaid enrollees between November 6 of the previous year and November 5 of the measurement year	9
Postpartum care	The percentage of deliveries that had a postpartum visit on or between 21 and 56 days after delivery	NQF #1517	Number of live births among RI Medicaid enrollees for which the mother received a postpartum visit	Number of live births among RI Medicaid enrollees between November 6 of the previous year and November 5 of the measurement year	9
Childhood immunization status	Percentage of children 2 years of age who had four diphtheria, tetanus and acellular pertussis (DtaP); three polio (IPV); one measles, mumps and rubella (MMR); three haemophilus influenza type B (HiB); three hepatitis B (HepB); one chicken pox (VZV); four pneumococcal conjugate (PCV); one hepatitis A (HepA); two or three rotavirus (RV); and two influenza (flu) vaccines by their second birthday. The measure calculates a rate for each vaccine.	NQF #0038	Number of RI Medicaid enrollees who received the recommended vaccine by their second birthday	Number of RI Medicaid enrollees who turn 2 during the measurement year	8
Supporting Home- and Community-Based Therapeutic Services (HBTS) for the Adult Population					
Use of HBTS services	Percentage of adult enrollees who access HBTS services	N/A	Number of RI Medicaid enrollees aged 21 and older who access HBTS services	Total number of RI Medicaid enrollees age 21 and older	11
Use of HCBS services	Percentage of enrollees who access HCBS services	N/A	Number of RI Medicaid enrollees who access HCBS services	Total number of RI Medicaid enrollees	11

Measure	Definition	Steward	Numerator	Denominator	RQ #
Type of HCBS services	Types of HCBS services utilized by enrollees, per the HCBS taxonomy categories	N/A	Number of RI Medicaid enrollees who access services in each HCBS taxonomy category ⁶	Number of RI Medicaid enrollees who access HCBS services	11
Institutionalization	Rate of institutionalization among homebound enrollees	N/A	Number of RI Medicaid enrollees who are institutionalized	Total number of RI Medicaid enrollees	11
Peer Recovery Specialist (PRS) and Family/Youth Support Partners (FYSP) Programs					
Access to physical health care	Percentage of enrollees in the program who accessed physical health care	N/A	Number of RI Medicaid enrollees in the program who access physical health care	Number of RI Medicaid enrollees participating in the program	7
Use of BH services	Percentage of enrollees accessing BH services	N/A	Number of RI Medicaid enrollees who use BH services	Number of RI Medicaid enrollees participating in the program	7, 10
BH ED visits	Number of behavioral health-related ED visits annually	N/A	Number of behavioral health-related ED visits incurred by RI Medicaid enrollees	Total number of ED visits incurred by RI Medicaid enrollees	7, 10
Follow-up after ED visit for mental illness	Percentage of discharges for patients who visited the ED with a primary diagnosis of mental health or alcohol/drug dependence and who had a follow-up visit to a provider within 7 or 30 days.	NQF #2605	Number of ED discharges with an outpatient visit within 7/30 days of ED discharge among RI Medicaid enrollees	Number of ED discharges with a primary diagnosis of mental health or other drug dependence among RI Medicaid enrollees	7
IMD use	Percentage of enrollees with IMD use	N/A	Number of RI Medicaid enrollees in the program admitted to an IMD	Total number of RI Medicaid enrollees in the program	10
Improving Access to Care for Homebound Individuals					
Primary care visits	Number of primary care visits per enrollee	N/A	Number of primary care visits among homebound RI Medicaid enrollees	Number of homebound RI Medicaid enrollees	11
Primary care home visits	Number of home-based primary care visits per enrollee	N/A	Number of home-based primary care visits among homebound RI Medicaid enrollees	Number of homebound RI Medicaid enrollees	11
ED use among homebound patients	Rate of ED visits among homebound patients	N/A	Number of homebound RI Medicaid enrollees in the program with one or more ED visits	Number of homebound RI Medicaid enrollees	11
Behavioral Health Link					
Access to physical health care	Percentage of enrollees in the program who accessed physical health care	N/A	Number of RI Medicaid enrollees in the program who access physical health care	Number of RI Medicaid enrollees participating in the program	7
Use of BH services	Percentage of enrollees accessing BH services	N/A	Number of RI Medicaid enrollees who use BH services	Number of RI Medicaid enrollees participating in the program	7, 10

⁶ Source: https://www.cms.gov/mmrr/Downloads/MMRR2014_004_03_b01.pdf

Measure	Definition	Steward	Numerator	Denominator	RQ #
BH/SUD/ODU ED visits	Number of behavioral health-related/substance use disorder-related/opioid use disorder-related ED visits annually	N/A	Number of BH/SUD/ODU related ED visits incurred by RI Medicaid enrollees	Total number of ED visits incurred by RI Medicaid enrollees	7, 10
Follow-up after ED visit for mental illness	Percentage of discharges for patients who visited the ED with a primary diagnosis of mental health or alcohol/drug dependence and who had a follow-up visit to a provider within 7 or 30 days.	NQF #2605	Number of ED discharges with an outpatient visit within 7/30 days of ED discharge among RI Medicaid enrollees	Number of ED discharges with a primary diagnosis of mental health or other drug dependence among RI Medicaid enrollees	7
IMD use	Percentage of enrollees with IMD use	N/A	Number of RI Medicaid enrollees in the program admitted to an IMD	Total number of RI Medicaid enrollees in the program	10
Promoting Access to Appropriate, High-Quality Mental Health and Substance Use Treatment by Waiving the Institutions of Mental Disease (IMD) Exclusion					
IMD use	Percentage of enrollees with IMD use	N/A	Number of RI Medicaid enrollees in the program admitted to an IMD	Total number of RI Medicaid enrollees in the program	10
Use of BH services	Percentage of enrollees accessing BH services	N/A	Number of RI Medicaid enrollees who use BH services	Number of RI Medicaid enrollees participating in the program	10
BH/SUD/ODU ED visits	Number of behavioral health-related/substance use disorder-related/opioid use disorder-related ED visits annually	N/A	Number of BH/SUD/ODU related ED visits incurred by RI Medicaid enrollees	Total number of ED visits incurred by RI Medicaid enrollees	10
Modernizing the Preventive and Core Home- and Community-Based Services Benefit Package					
Use of HCBS services	Percentage of enrollees who access HCBS services	N/A	Number of RI Medicaid enrollees who access HCBS services	Total number of RI Medicaid enrollees	11
Minimizing institutional length of stay	Percentage of admissions to an institutional facility that result in a successful discharge to the community within 100 days of admission	CMS ⁷	Number of discharges from an institutional facility to the community that occurred within 100 days of admission	Number of admissions to institutional facilities between July 1 of prior year and June 30 of measurement year, not including direct transfers	11
Successful transition after institutionalization	Percentage of long-term institutional facility stays that result in successful transitions to the community	CMS	Number of discharges from an institutional facility to the community that result in successful transition to the community for 60 consecutive days	Number of institutional facility discharges with a length of stay of at least 101 days between July 1 of previous year and June 30 of measurement year	11

⁷ Source: https://www.medicaid.gov/medicaid/managed-care/downloads/ltss/mltss_assess_care_plan_tech_specs.pdf

Chapter 5: Data Sources & Acquisition Plans

In this chapter, we describe our data sources and outline our planned approach to acquiring and organizing these data for use in our evaluation. We also detail the relevant structure and procedures that we have in place for securing access, storage, linkage, analysis, and transmittal of the data that we collect. **Exhibit 7** lists the current known data sources for this evaluation.

Exhibit 7: Proposed Evaluation Data Sources

Data Source	Years	Source	Use	Example Attributes
Demonstration program documents and data	2018-2023	EOHHS	<ul style="list-style-type: none"> Identify program characteristics and outcomes 	<ul style="list-style-type: none"> Program implementation progress Number of members enrolled in a program Intensity of member engagement in program
Medicaid claims and encounter data	2013-2023	EOHHS	<ul style="list-style-type: none"> Identify health, cost, utilization, and quality outcomes for Medicaid beneficiaries 	<ul style="list-style-type: none"> Beneficiary demographics (e.g., age, gender, race/ethnicity) Beneficiary health status (e.g., chronic conditions) Utilization (e.g., ED visits, inpatient outpatient visits) Cost of care per beneficiary; total and broken out into service/setting categories
EOHHS Quality Evaluation data	2018-2023	EOHHS	<ul style="list-style-type: none"> Provide context for claims-based findings 	<ul style="list-style-type: none"> AE member experience and satisfaction

Claims & Encounter Data Acquisition

We will work with EOHHS to select appropriate internal and external data sources to adequately address each research question. We will utilize Rhode Island Medicaid claims and encounter data in this evaluation for our analysis when possible; as of June 2019, NORC and EOHHS have in place an agreement (via the signed contract for this evaluation) that allows EOHHS to share Rhode Island Medicaid data with NORC. EOHHS is scheduled to transmit claims and encounter data to NORC on a quarterly basis via the dedicated Secure File Transfer Protocol (SFTP) site. Below we outline steps for gaining access, checking and linking the secondary data sources.

Data Security. Prior to downloading any data or analytic results through the SFTP, we will follow EOHHS's and NORC's institutional confidentiality protection procedures to ensure that files are devoid of personally identifiable information (PII) or protected health information (PHI). NORC's computer and data security program is compliant with federal government regulations and will be adapted to the requirements of this project, as needed. We enforce physical security measures designed to ensure that access to confidential data are restricted only to those employees who possess the need, as well as the authorization, to view such information. We protect project materials through a multi-tiered approach of access control and monitoring, data encryption during transmission, and continuous upgrade of plans and policies to align with the changing security environment. All electronic project files and programs are stored on secure servers, and access to this project's shared space, managed by NORC, is restricted to authorized team members with clearance to use specific data. NORC provides partitioned network storage for each project to mitigate the potential for data loss due to accidents, computer equipment malfunction, or human error, as well as to administer appropriate access rights.

NORC will honor the data use restrictions identified in the business associate agreement (BAA) and will not use government data provided in this contract for purposes outside the scope of this project without explicit permission from EOHHS in writing.

Data Quality Checks. At each step in the analytic process, we will check for missing data, systematic errors, and unexpected outliers. If there appear to be errors in the data, we will reconcile them directly with EOHHS. For the Rhode Island Medicaid data, we will match the variables in the datasets to the data dictionaries, provided by EOHHS, verify variable formats and identify missingness, and we will run frequency and distribution checks on the variables to confirm consistency and standardization of the data throughout the evaluation. With the start of the analysis, NORC will check and document code and output created for the evaluation.

Dataset Flow. The NORC team has developed and will implement a comprehensive data flow plan to ensure that we securely and accurately integrate Rhode Island data from multiple environments for our evaluation. Files from EOHHS and other state of Rhode Island departments will be transferred to NORC through a SFTP site, to which EOHHS staff have access. NORC will then transfer the files to our internal secure data environment, where the subsequent data management and analysis will take place. At every stage in the process, files will undergo thorough quality assurance checks. **Exhibit 8** displays the proposed data flow process for this evaluation; we will work with the Rhode Island analytics teams to ensure this process is as coordinated and as efficient as possible.

Exhibit 8: Proposed Data Process Flow

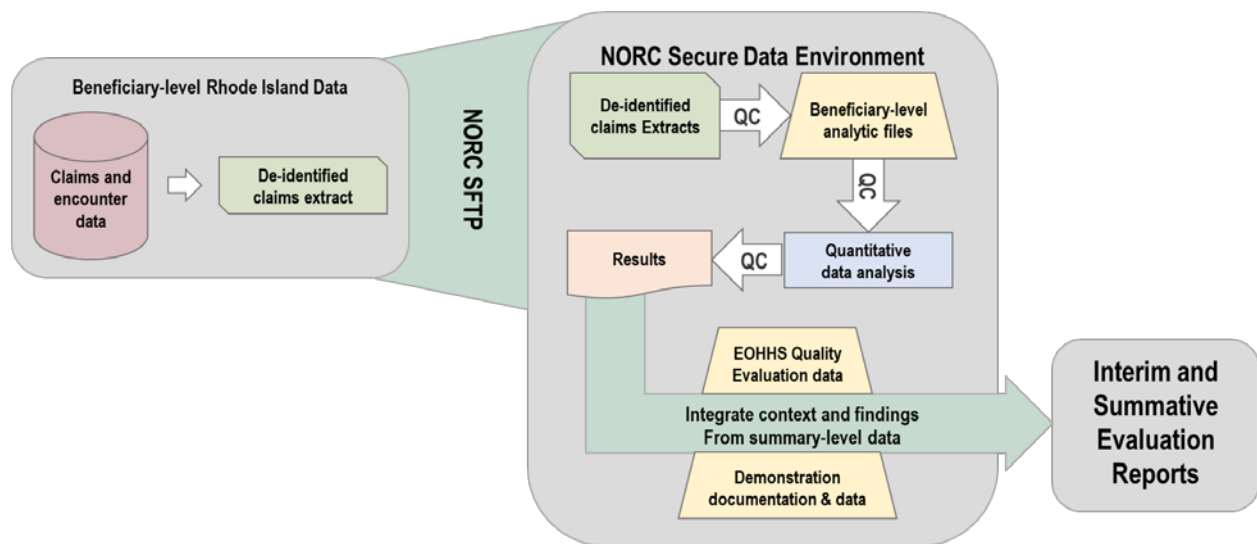

Non Claims-Based Data Acquisition

We plan to integrate non claims-based context and findings from demonstration program documents and data (including behavioral health data from BHDDH), the EOHHS Quality Evaluation, into this evaluation. We do not anticipate that these documents and/or data will include beneficiary-level detail, and thus will not be integrated into the beneficiary-level models measuring impact; rather, we will use

them primarily to contextualize our claims-based findings. These documents and/or data will originate with EOHHS and/or BHDDH, and we will work closely with the relevant teams to ensure the efficiency and security of data flow. Generally, we will follow the process below for any type of non-claims data request:

- Identify potential documents and/or data sources in discussion with data owner (EOHHS or BHDDH);
- Develop and confirm list of documents and/or data sources, iterating with data owner as needed;
- Decide on transmission method, timing, and format with data owner; and
- Confirm receipt and notify data owner of any irregularities observed in the data during the quality control process.

As mentioned above, we have set up a dedicated SFTP site for this project; we anticipate that most of the documents and data will be transmitted through that site; however, we are flexible and open to alternatives per consultation with EOHHS. We will also provide support where needed (e.g., generate usernames and passwords for additional members to access the SFTP site, provide technical support), and will reach out to EOHHS immediately if anomalies are observed at any point in the process.

Chapter 6: Analytic Methods

In this chapter, we describe our proposed methods for quantitative claims-based analyses used to evaluate Rhode Island's 1115 Medicaid waiver extension. The goals of the quantitative analyses are to characterize the programs and their beneficiary populations, as well as to assess the overall impact of the program on outcomes including spending, utilization, and access to care.

Overall, we anticipate being able to conduct impact analyses using multivariate difference-in-differences (DiD) analyses with comparison groups for the AE program only; due to small sample size and low feasibility of creating an appropriate comparison group for the remainder of the waiver programs, we will primarily rely on descriptive analyses (i.e., summary statistics, pre-post analysis) unless EOHHS opts to expand the range of data sources and methods to be included in the evaluation. To the extent possible, we will also incorporate non-quantitative implementation and process findings from the EOHHS Quality Evaluation (e.g., how AEs are integrating CurrentCare or the APCD into their workflow) to identify key drivers of success and potential causal relationships. **Exhibit 5** above details our proposed analytic approach to each waiver program.

Analytic Methodology for Claims-Based Data

As described in **Exhibit 5** above, we will utilize a number of quantitative methods to estimate the impact of these programs on claims-based and non-claims-based outcomes. First, we will undertake descriptive analyses for all waiver programs, which include summary statistics (using chi-squared tests) and pre-post analyses. Where possible, we will use our findings from the descriptive analyses to develop multivariate models for outcomes, using interrupted time-series (ITS) and DiD analysis. We will utilize the ITS and DiD designs where sample size and data availability allow; we anticipate that for most non-AE programs and outcomes this will not be possible and this evaluation will rely on descriptive (e.g., summary statistic and pre-post) analyses.

Program-Specific Treatment Group. Identification of the treatment group is an important first step in the analysis for each program. Medicaid enrollees who are attributed to an AE will be indicated in the data with a flag; for all other programs, enrollees who received services from a particular program will be identified from the claims based on documentation (e.g., diagnosis codes, visits to a specific provider) provided by EOHHS.

Potential Comparison Groups. Where possible, we will identify program-specific comparison groups using national or state-defined standards and/or benchmarks. These may include within-state comparison groups made up of eligibility groups not subject to a particular program, historical in-state benchmarks using Rhode Island Medicaid claims and encounter data, or national comparison data from the Child and Adult Core Set measures.⁸ To define inclusion and exclusion criteria for program-specific comparison groups, we will consider a number of factors including sample size, data availability, and the

⁸ CMS releases information annually on state progress in reporting the Adult Core Set measures and assesses state-specific performance for measures that are reported by at least 25 states and which met internal standards of data quality.

comparability of the proposed comparison group to the target population based on observable characteristics.

We anticipate establishing within-state comparison groups for three programs: the Health System Transformation Project, Piloting Dental Case Management, and Behavioral Health Link. **Exhibit 9** describes the inclusion criteria for the proposed treatment and comparison groups for these programs. Given the limited scope, broadly defined eligibility criteria, and small number of participating enrollees it will be challenging to identify valid within-state comparison groups for the remaining demonstration programs. For these programs, we will explore the possibility of using historical comparison groups as well as national or external benchmarks for context.

Exhibit 9: Proposed Treatment and Comparison Groups

Program	Target Population/Treatment Group	Proposed Within-State Comparison Groups
Health System Transformation Project (HSTP)	<ul style="list-style-type: none"> RI Medicaid-only beneficiaries enrolled in managed care, attributed to an AE. 	<ul style="list-style-type: none"> RI Medicaid-only beneficiaries enrolled in managed care, not attributed to an AE.
Piloting Dental Case Management	<ul style="list-style-type: none"> RI Medicaid enrollees ages 18 and over in the traditional fee-for-service dental delivery system, seen at participating dental practices 	<ul style="list-style-type: none"> RI Medicaid enrollees ages 18 and over in the traditional fee-for-service dental delivery system, seen at participating dental practices
Behavioral Health Link	<ul style="list-style-type: none"> Adult Medicaid enrollees in crisis due to substance or behavioral health conditions treated through the Behavioral Health Link triage center 	<ul style="list-style-type: none"> Adult Medicaid enrollees receiving "usual care" for substance use or behavioral health events in an emergency department.

Descriptive Analysis

Summary Statistics. Summary statistics, including frequencies and percentages of unadjusted beneficiary covariates and outcomes, will be reported to characterize the member characteristics in both the treatment and the comparison groups. Descriptive analyses will be focused on program features, organizational characteristics, approaches, providers, and beneficiary populations. Where applicable, we will compare the observed characteristics to other state and national benchmarks using appropriate statistical analyses (e.g. t-tests or chi-squared tests). Results of our descriptive analyses will be presented in tables and visuals, in the interim and final evaluation reports; these will likely also be included in the quarterly monitoring reports to CMS.

Pre-post Analysis. For core and program-specific outcomes, we will conduct pre-post analyses that will allow us to monitor the progress of program implementation and selected utilization, cost, and quality measures via waiver documents and Rhode Island Medicaid claims and encounter data, respectively. Examples of outcomes that will be presented in the pre-post analyses include number of beneficiaries touched by a program, rate of inpatient admissions, and average Medicaid spending per-member-per-month. Additionally, this analysis will inform the development of multivariate models by identifying key covariates and outcomes to emphasize for those models.

Impact Analysis

Interrupted Time-Series. Where data quality and sample size allow, we will assess program-specific outcomes using an ITS design. We will track outcomes observed in the demonstration period and during a two-year baseline period before the program-specific implementation date. Average outcomes in each time period will be estimated with a multivariate model; this will allow our team and EOHHS to track changes in performance over the evaluation period, and will provide valuable insight when compared to the baseline period data. Results will be presented visually and graphically (e.g., run charts) and in tables in the interim and final evaluation reports. We will estimate ITS models using the following segmented linear regression equation:

$$Y_t = \beta_0 + \beta_1 T + \beta_2 X_t + \beta_3 T X_t$$

Where Y_t is the outcome at time t , T represents the time elapsed since the start of the program, β_0 represents the baseline (where $T=0$), X_t is a dummy variable indicating the pre-intervention period, and β_2 is the level change following the intervention and β_3 indicates the slope change following the program.⁹

Difference-in Differences. We propose to use DiD models to conduct impact analyses for the AE program only. DiD models are used to estimate the effect of an intervention by comparing the changes over time between treatment and comparison groups. The DiD design will adjust for time-invariant characteristics of intervention and control groups, or factors that vary over time and effect both groups in the same manner. Pending an assessment of sample size and data availability and quality, we propose to use a DiD design to estimate program impacts for the AE program because this program has a readily available comparison group consisting of Medicaid managed care beneficiaries not enrolled in the AE program. In discussions with EOHHS, we determined that a FFS comparison group was not feasible because the vast majority of RI Medicaid enrollees are in managed care, and that the FFS is inherently made up of a very different population; thus for sample size and comparability issues, we will pursue only a comparison group with managed care beneficiaries. The comparison group will be identified as the enrollees not flagged as participating in an AE, as previously described.

For each outcome measure, we will choose the appropriate model specification based on the observed distribution (e.g., variance, skew, and kurtosis) of the outcome. Next, we will use DiD regression models to estimate the impact of AEs, including relevant covariates based on our empirical model of causality, and adjusting standard errors to account for clustering of observations within appropriate groups. We will use DiD regressions to estimate the effect of the waiver extension programs on each outcome measure using the following equation:

$$gg [EE(Y_{iiii})] = \beta\beta_0 + \theta\theta M M M M M M M M E E_{ii} * I I_{ii} + \beta\beta_1 M M M M M M_{ii} + \delta\delta_{ii} Y Y Y Y Y Y r r_{ii} + Y Y B B E E B B E E_{iiii} + \Pi\Pi M M M M M M M M_{ii}$$

Where YY represents the outcome of interest and $\theta\theta$ the DiD parameter for the effect of AEs; ii indexes beneficiary, jj the community¹⁰, tt the time period (year); $M M M M M M M M_{ii} = 1$ for communities in Rhode Island and

⁹ Bernal, J. L., Cummins, S., & Gasparrini, A. (2017). Interrupted time series regression for the evaluation of public health interventions: a tutorial. *International Journal of Epidemiology*, 46(1), 348–355. <https://doi.org/10.1093/ije/dyw098>

¹⁰ Community-level variables will be used for social-determinants of health for which we cannot derive individual measures.

$I_{it} = 1$ for time point after program implementation. The other additive terms control for baseline difference between the treatment and comparison groups, fixed year effect, beneficiary characteristics, and community features, respectively. We will choose $gg(\bullet)$, a link function from the exponential family, according to the outcome distribution. We will establish three baseline years (July 2014 – June 2016) to assess impact of the model during the HSTP performance period (July 2018 – June 2022). The pilot period (July 2016 – June 2018) will be considered as an implementation ramp-up period and will be excluded from both baseline and performance periods.¹¹

Examining Parallel Trends for the DiD Model. An assumption of DiD is that the impact of the treatment can be inferred because the treatment and comparison group in the pre-period had constant and parallel trajectories. In other words, the rate of change observed in the pre-period is the same for the treatment and comparison groups and would hold constant in the post period in the absence of the intervention. To test for this empirically, we will use regression models that include an interaction of each year on the treatment group and examine if the coefficients for the change between the earliest and most recent base years are significantly different from zero (indicating violation of the assumption).

If our preliminary analyses indicate that the parallel trends assumption is violated, we will use a generalized DiD estimation framework.¹² Under this framework, we will first test for a set of assumptions of parallel trends of different orders, then use the test results to specify our DiD model that, when necessary, accounts for violations of parallel trends with polynomial time-interaction terms.

Addressing Selection Bias. Because enrollment in the AE program is non-random, we assume that individuals in the treatment group may be systematically different from those in the comparison group, a phenomenon known as selection bias. To obtain unbiased estimates of model impacts from our DiD analyses, we propose addressing selection bias using inverse probability of treatment weighting (IPTW), appropriate for such a DiD design.¹³ First, we propose to estimate the propensity score as the *predicted probability* of a beneficiary being in the treatment group for each year using a logit model. In addition, we will compute propensity score weights for beneficiaries in the treatment and comparison groups as the relative predicted probability of a beneficiary being in the treatment group. Beneficiaries in the treatment group will receive a weight of one, and individuals in the comparison group will receive a weight of $PS_i/(1-PS_i)$, where PS_i is the predicted probability of the beneficiary being in the treatment group, given a set of observed covariates. The propensity score model will include beneficiary-level covariates such as demographic characteristics, enrollment, health status, socioeconomic characteristics, and access to care.

Before and after applying propensity score weights we will assess and confirm sample size for the weighted comparison group, and covariate balance between the treatment and comparison groups.¹⁴ The

¹¹ If required, we will check sensitivity of our impact estimates to include this ramp-up period in the performance period of the model.

¹² Ricardo Mora and Iliana Reggio, “Treatment Effect Identification Using Alternative Parallel Assumptions,” 2012.

¹³ E. A. Stuart, H. A. Huskamp, K. Duckworth, J. Simmons, Z. Song, M. E. Chernew, and C. L. Barry, “Using Propensity Scores in Difference-in-Differences Models to Estimate the Effects of a Policy Change, *Health Services and Outcomes Research Methodology* 14, no. 4 (2014): 166-182.

¹⁴ We assess common support by visually inspecting overlap in distribution of estimated propensity scores across treatment and comparison groups. We compute standardized differences in baseline covariates between treatment and comparison groups to assess balance.

propensity weights estimated above will be incorporated into our DiD models to provide the unbiased estimates for average treatment effect in the treated population (ATT).

Sensitivity Analyses

To test the robustness of the results of the impact analyses, we will conduct a number of sensitivity analyses for ITS and DiD models. These will include examining differential effects by AE (sample size permitting), and including the pilot in the post-treatment periods as opposed to considering it as a ramp-up period and excluding it from the analysis. Additionally, we will conduct sensitivity analyses varying the attribution methodology for the AEs. In primary analyses we will use the attribution lists generated by the MCOs (described in **Exhibit 3**). In sensitivity analyses we will apply retrospective attribution based on utilization, and compare the attributed populations and results from impact models.

Subgroup Analyses

Individual responses to these programs may differ from the average treatment effect for a variety of reasons; therefore, it is important to examine whether or not the effect of a program varies across beneficiary subgroups.¹⁵ Sample size permitting, we will examine the variation in impacts for select beneficiary characteristics, including age (e.g., children, non-elderly adults, and elderly/dually-enrolled adults), race/ethnicity, health status (e.g., specific conditions, substance use disorders, multiple chronic conditions, co-morbid behavioral and physical health diagnoses, and serious and persistent mental illness), and Medicaid enrollment category. As programs are implemented and we learn more about the characteristics of the program populations, we will work with EOHHS to identify other relevant populations for further subgroup analysis.

Sample Size and Power Calculations

NORC will assess the effect size or minimum detectable effect (MDE) as part of the power analysis for each outcome variables. MDE is the smallest true effect in the average of outcome between treatment and comparison groups that we will be able to detect in our proposed study designs. For analyses of performance outcomes using RI Medicaid claims and encounter data, sample size and power considerations depend on our evaluation study designs.

Effect Size for Pre-Post Analysis. We expect to be adequately powered to analyze Rhode Island Medicaid claims and encounter data with a pre-post design for the program-specific treatment groups. For m members clustered within k groups (group will vary by waiver program), the total sample size for the pre-post design for a continuous outcome variable of interest, mn^* , is given by:

$$mn^* = mn^*kk^* = \left(\frac{t_{\alpha} + t_{\beta}}{2} \right)^2 \frac{\sigma^2}{\delta^2} (1 + (m - 1)\rho)$$

¹⁵ Kravitz RL, Duan N, Braslow J. Evidence-based medicine, heterogeneity of treatment effects, and the trouble with averages. *Milbank Q.* 2004;82(4):661–687. Erratum in: *Milbank Q.* 2006, 84(4): 759–760.

Where, α is the probability of committing a type 1 error, and $1-\beta$ is the power, σ^2 is the variance of the outcome, $\delta\delta$ is the MDE, $(1 + (mm - 1)\rho\rho)$ is the variance inflation factor, and ρ is the intraclass correlation.

Effect Size for ITS Analysis. Multiple factors affect the power of ITS analysis including sample size per time point, expected effect size, location of intervention in the time series, and pre-intervention trends.¹⁶ We will use a simulation-based approach to estimate power and MDE for all ITS models. Following a method developed by Zhang and colleagues, we will conduct a series of *a priori* simulations to estimate power and required sample size for ITS models.¹⁷

Effect size for DiD Analysis. We expect to be adequately powered to perform DiD regression models to for only some programs and outcomes, based on sample size and data availability and quality. For m members clustered within k groups, the total sample size for the DiD design for a continuous outcome variable of interest, mn^* , is given by:

$$mn^* = mm^*kk^* = (1 - r^2) \left(\frac{t_{\alpha\alpha}}{2} + t_{\beta\beta} \right) 2 \frac{\sigma^2}{\delta\delta^2} (1 + (mm - 1)\rho\rho)$$

Where r is the total variance composed of the time invariant components. In reporting results for our cross-sectional and DiD design, NORC will specifically denote the MDE for each outcome of interest, for a given sample size at 80 percent powered and two-tailed alpha of 0.05 or 0.10.

Methodological Challenges & Proposed Solutions

We are aware and attentive to external factors and statistical results that may impact the evaluation design, and are prepared to respond with various solutions to adapt our design as necessary, while still providing Rhode Island with a high-quality evaluation. For instance, we acknowledge that disentangling the program-specific effects of these overlapping programs in the context of other reform initiatives (e.g., SIM) will be a challenge. To address this, we propose a number of strategies, including identifying specific groups (e.g., geographic areas, groups of providers) that are targeted or involved in other initiatives and incorporating that information into adjusted regression models as a covariate; and taking advantage of the rich data included in Rhode Island Medicaid claims and encounter database in order to identify members who received services under another initiative. **Exhibit 10** notes several additional challenges and proposed solutions that are specific to this evaluation.

¹⁶ Hawley, S., Ali, M. S., Berencsi, K., Judge, A., & Prieto-Alhambra, D. (2019). Sample size and power considerations for ordinary least squares interrupted time series analysis: a simulation study. *Clinical Epidemiology*, *11*, 197–205. <https://doi.org/10.2147/CLEP.S176723>

¹⁷ Zhang, F., Wagner, A. K., & Ross-Degnan, D. (2011). Simulation-based power calculation for designing interrupted time series analyses of health policy interventions. *Journal of Clinical Epidemiology*, *64*(11), 1252–1261. <https://doi.org/10.1016/j.jclinepi.2011.02.007>

Exhibit 10: Key Evaluation Challenges and Proposed Solutions

Challenges	Proposed Solutions
Data quality may vary for some sources	<ul style="list-style-type: none"> ▪ Assess the usability, completeness, and quality of data before beginning analysis ▪ Follow an iterative quality control process to maintain integrity for all data files and rigor of analysis
Non-parallel baseline trends that violate assumptions of DiD regression	<ul style="list-style-type: none"> ▪ Adopt generalized DiD estimator, perform rigorous checks on assumptions of parallel trends of different orders, and incorporate group-specific time-trend polynomials to control for violation
Heterogeneity in impacts across subgroups not captured in focus on overall impacts	<ul style="list-style-type: none"> ▪ Perform subgroup analysis to compare impacts on outcomes ▪ Include fixed effects and/or interaction terms in regression models ▪ Draw insights from qualitative and mixed-methods findings to contextualize findings and determine appropriate subgroups where relevant
May be difficult to isolate program-specific effects of overlapping demonstration programs in the context of other reform initiatives	<ul style="list-style-type: none"> ▪ Assess the impact of the program within the context of other state/federal interventions by understanding the similarities and differences between HSTP and other initiatives through our review of demonstration and program documents ▪ Include covariates indicating participation in other demonstration programs or other statewide CMS initiatives in impact analyses ▪ Explore the possibility of subgroup analyses (sample size permitting) for programs in which a large proportion of the participants are also involved in another demonstration program or initiative
Sample size concerns for subgroup analyses	<ul style="list-style-type: none"> ▪ Investigate subgroup sample sizes prior to conducting the statistical analysis, and conduct power analyses as needed. ▪ Multivariate statistical analysis might be unable to perform on inadequately sized subgroups; in these cases we will try to integrate information from the EOHHS Quality Evaluation to speak to the effect of the program on different subgroups.

Chapter 7: Reporting

Over the course of this evaluation, NORC will work with EOHHS to prepare quarterly and annual monitoring reports for CMS, as well as interim and summative evaluation reports. Our proposed strategy for these reports are described below.

Report Template Development

Before drafting any report for this evaluation, we will consult with EOHHS about specifications for a style guide, content of deliverables, and process and timelines for report development, in addition to referring to CMS guidelines provided for 1115 demonstration evaluation reports. NORC will draft proposed templates, including research questions and topics, high-level findings, and potential data visualization, for EOHHS review at least two weeks before report production begins. This will allow us to incorporate EOHHS feedback into the first draft. During the bi-weekly check-in calls and/or annual in-person meetings, NORC will lead a discussion of the proposed template for each report. We will make further refinements to the report template based on EOHHS' feedback during these meetings, and will produce a revised template for EOHHS approval well in advance of the deadline for the report's initial draft. By clearly laying out the report template before the writing process begins, NORC and EOHHS hope to decrease the number of revisions required to the submitted report. All reports will receive a technical or substantive edit from team subject matter experts, structured peer-review by NORC senior leadership, and copyediting before submission to EOHHS.

Interim & Summative Evaluation Reports

NORC will develop the interim evaluation report based on the qualitative and quantitative data and analyses performed throughout the course of the evaluation to date. While this is not a final summative report, it will provide EOHHS and CMS with a helpful performance snapshot of HSTP over a longer period of time than the annual reports in terms of quantitative and qualitative outcomes. The draft interim evaluation report will be submitted to CMS by December 31, 2022, with a final version submitted by April 30, 2023.

The interim evaluation report will address specific research questions related to the three research domains described earlier in this document, as well as indirectly addressing the impact on efficiency, transparency, and flexibility:

- Pay for value, not volume
- Coordinate physical, behavioral, and long-term care; and
- Rebalance delivery system away from high-cost settings.

NORC will produce a summative evaluation report as a compilation of the findings from the interim evaluation report and subsequent evaluation findings. It will follow the template of the interim report and provide EOHHS and CMS with comprehensive evaluation findings through a more in-depth assessment

of central research questions driving the success of the waiver programs. The draft summative evaluation report will be submitted to CMS by June 30, 2025, with a final version submitted by October 31, 2025. In addition to updates on the topics addressed in the interim evaluation report, the final evaluation report will include final implications of evaluation results for future initiatives and a discussion of how elements of the waiver were and/or were not sustained after the expiration of this waiver (December 31, 2023).

Quarterly & Annual Monitoring Reports

As part of this contract, NORC will also contribute to the quarterly and annual monitoring reports required by CMS for this waiver extension. NORC will work closely with EOHHS to identify appropriate parts of the report that we can contribute; generally, we expect that the most updated claims-based outcomes will be provided by NORC for inclusion into the reports.

Once the measures required for the monitoring reports have been finalized by NORC and EOHHS, NORC data analysts will develop a series of programs that will create the required measures from the Rhode Island Medicaid claims and encounter data and generate the desired monitoring output. All programs developed for the quarterly and annual monitoring reports will go through a rigorous process of quality checks, including specification checks, version checks, and integration tests, among others. All output will be generated and sent to EOHHS in an agreed-upon format.

Chapter 8: Evaluation Workplan & Budget

NORC will use and continue to build out the schedule of activities laid out in this EDP to guide all evaluation activities and operationalize how the project will meet major milestones. We will submit all deliverables to EOHHS and CMS in the appropriate format by the appropriate due date.

In order to most efficiently use our resources, we will coordinate evaluation activities to the greatest extent possible, including in-person meetings, timing of data analysis, and report production timelines. Data and measure development will be ongoing throughout the course of the evaluation, with findings reported in the two evaluation reports. The interim and final evaluation reports will contain findings from all facets of the evaluation, including qualitative findings from the Quality Evaluation conducted by EOHHS. The evaluation budget is detailed in **Exhibit 11**.

Exhibit 11: Evaluation Budget

Personnel and Contracted Services	Per Calendar Year							Total Cost
	2019	2020	2021	2022	2023	2024	2025 (10 months)	
Evaluation Design	\$ 183,223	\$ -	\$ -	\$ -	\$ -	\$ -	\$ -	\$ 183,223
Interim Evaluation Report	\$ -	\$ 201,903	\$ 184,083	\$ 411,078	\$ 383,663	\$ 128,390	\$ -	\$ 1,309,118
Summative Evaluation Report	\$ -	\$ -	\$ -	\$ -	\$ 95,916	\$ 374,107	\$ 519,519	\$ 989,542
Total Personnel/Contracted Services Costs	\$ 183,223	\$ 201,903	\$ 184,083	\$ 411,078	\$ 479,579	\$ 502,497	\$ 519,519	\$ 2,481,884
Other Direct Costs (Supplies/Equipment/Software/	\$ 14,658	\$ 16,152	\$ 14,727	\$ 32,886	\$ 38,366	\$ 40,200	\$ 41,562	\$ 198,551
Total Contract Budget	\$ 197,881	\$ 218,055	\$ 198,809	\$ 443,965	\$ 517,946	\$ 542,697	\$ 561,081	\$ 2,680,435

Chapter 9: Staffing & Communication

Staffing Plan

Project Directors Kristina Lowell, PhD, and Scott Leitz, MA, will have overall responsibility for this evaluation, with the support of Project Manager Erin Ewald, ScM, and the individual Task Leads. Lowell and Leitz will direct the NORC team and will be responsible for guiding and managing the entire project. Subject matter experts from our partners at The MHC group will assist with providing Rhode Island health policy context and history. **Exhibit 12** displays the organization of the NORC evaluation team.

Exhibit 12: NORC Evaluation Team

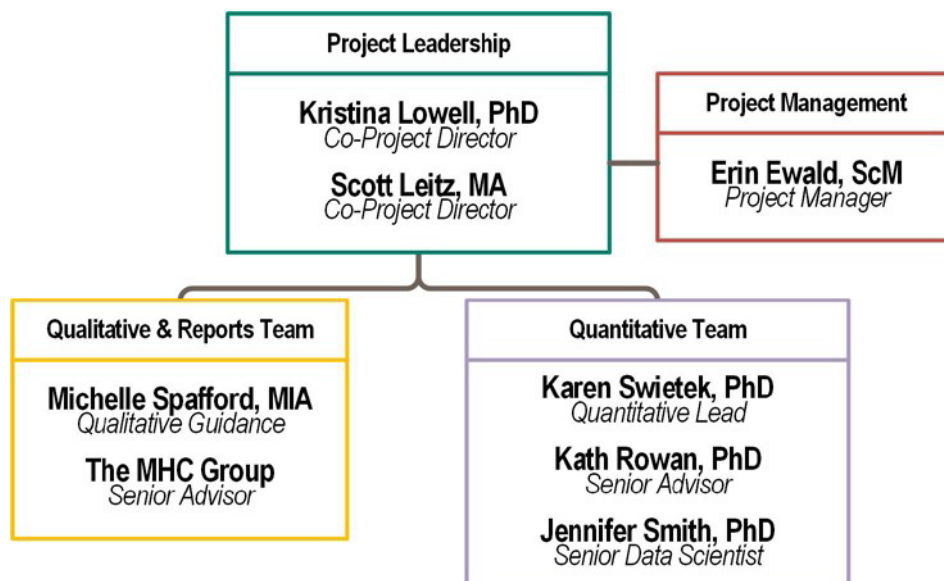

Communication Plan

Client Communications

EOHHS and NORC will hold bi-weekly one-hour calls to provide a checkpoint on production metrics, status of deliverables, and potential variances from the schedule. NORC will prepare an agenda for distribution in advance of each meeting, as well as detailed minutes that serve as a record of key discussion and decision points. NORC will immediately communicate any significant issues and their proposed resolutions to the project lead.

NORC will communicate early and frequently with EOHHS to acquire data at the appropriate times, identify and resolve challenges with either primary or secondary data collection, and facilitate smooth communication with other Rhode Island state departments. We will also use regular email communication and ad hoc meetings with EOHHS to facilitate project progression. NORC will triage all email

communications to ensure necessary parties are working together to keep the project running seamlessly, and will work with EOHHS to identify when ad hoc conference calls are needed and include appropriate staff. NORC will direct emails and meeting materials to the EOHHS project manager, who will share the information with EOHHS colleagues.

These formal and informal communications will guarantee an optimal understanding of EOHHS's needs. We will monitor and update meeting schedules and communications methods regularly as needed.

Internal Communication

The NORC management team will meet weekly to discuss current activities and management priorities. NORC will also hold weekly project meetings/calls for the team to report on progress, milestones, and variances from original plans. The management team will meet regularly with a set of working groups organized around research domains and consisting of members across both quantitative and qualitative teams.

Communications with Consultants

As part of their seamless integration into the project team, our consultants at The MHC Group will take part in regular and ad hoc meetings and communications, leveraging processes established during prior partnerships. Project Manager Ewald will be the designated liaison for the MHC Group, ensuring that the lines of communication remain open and clear, and working closely with both teams to resolve any issues.

Appendix A: Draft Evaluation Report Template

Visual Summary (1 page)

- Waiver impact on total cost
- Waiver impact on utilization and quality of care
- Basics about 1115 waiver programs
 - Background and purpose
 - Number of attributed members
 - Previous APM experience

Executive Summary (5 pages)

- Brief overview of evaluation
- High-level findings to date
 - Results for outcome measures (cost, utilization, quality)
 - What is the impact of the waiver programs on beneficiaries participating in a waiver program, compared to those who fall outside of these activities?
- How do results relate to program features (e.g., structure, type of providers, etc.) and implementation approaches to date?
- What's next in the evaluation?

Chapter 1: Introduction (5 pages)

- Overview of chapter
- Narrative of Rhode Island context and our implementation findings: 1) what have the waiver programs accomplished to date in terms of outcomes (claims and quality measures); 2) where are they on the development in terms of structure and implementation experience (i.e., infrastructure transformation); 3) what drivers appear to explain their performance to date and what infrastructure appears to be needed to be successful?
 - a. Previous APM experience for providers (e.g., the pilot program)
 - b. Emphasis on transformation being a process over time
 - c. What difference does it make to be taking part in a waiver program for leadership and providers?
- Overview of the 1115 Waiver and relevant programs
- Overview of NORC's evaluation
- Overview of this report
- What research domains are addressed at least in part, organized according to research domains in the evaluation design plan
 - a. In the first AR, we will answer many questions only partially and expect to return to the same questions in subsequent reports with additional information
- Limitations of this report:
 - a. Initial set of claims-based findings, for a limited period of performance;
 - b. Small sample size in programs leading to a limited analytic capacity;
 - c. Initial assessment of EOHHS qualitative data;

- d. Lack of primary data collection.
- Summary

Chapter 2: Impact of RI Section 1115 Medicaid Waiver (5 pages)

- Overview of chapter and key findings
- Anticipated hypotheses related to evaluation domains
 - Program impact on the total spending, utilization, and quality of care for attributed patients as well as among key populations (e.g., dual diagnosis, patients with multiple chronic conditions)
- Data sources (claims) and measures (outcomes and covariates) for cost, utilization, and quality metrics
- Approach (move most technical details to appendix)
 - Qualitative Data Analysis
 - Thematic analysis of qualitative data sources
 - Quantitative Data Analysis
 - Pre-post trend analysis (entire Medicaid population)
 - Construction of treatment and comparison groups (AE program only)
 - Propensity score weighting (AE program only)
 - Difference-in-differences models (AE program only)
 - Identification of key subgroups (as sample size allows)
- Analysis of trends in Medicaid spending, utilization, and quality of care
- Discussion
 - Limitations of analysis
 - Next steps for analysis
- Summary of chapter

Chapter 3: Impact of Individual Waiver Programs (10 pages)

- Impact on Medicaid spending, utilization, and quality of care
- All measures presented for waiver programs, pooled and separated for each program
 - Tables and visuals incorporated
- Impact analyses for HSTP
 - DiD (or other comparison group methods)
 - Examine parallel trends for the DiD model
 - Subgroup analysis
 - Address selection bias
 - Sample size and power calculations
- Interrupted time-series and/or pre-post analyses for the eight other waiver programs:
 - Pilot Dental Case Management;
 - Covering Family Home Visiting Programs to Improve Birth and Early Childhood Outcomes;
 - Supporting Home- and Community-Based Therapeutic Services for the Adult Population;
 - Peer Recovery Specialist (PRS) and Family/Youth Support Partners (FYSP) Programs;

- Improving Access to Care for Homebound Individuals;
- Behavioral Health Link;
- Promoting Access to Appropriate, High-Quality Mental Health and Substance Use Treatment by Waiving the Institutions of Mental Disease (IMD) Exclusion;
- Modernizing the Preventive and Core Home- and Community-Based Services Benefit Package
- Discussion
 - Limitations of analysis
 - Next steps for analysis
- Summary of chapter

Chapter 4: Qualitative Findings: Beneficiary and Provider Experience (5 pages)

- In this chapter, we will systematically analyze findings from the EOHHS Quality Evaluation, which will speak to the qualitative beneficiary and provider experience in the waiver programs.
- Data source: data from EOHHS Quality Evaluation
 - Specific content and type of qualitative findings will be determined in close consultation with EOHHS
- Methods for data collection and analysis
- Emerging themes from qualitative findings may include (specific themes to be determined based on data available):
 - Program implementation experience
 - Beneficiary experience with waiver programs
 - Provider experience with waiver programs
 - Effective strategies for outreach and partnerships
 - Program coordination and management approaches
 - Waiver-wide coordination and services tools/tracking

APPENDICES

- A) Glossary of terms and acronyms
- B) List of evaluation research domains and research questions
- C) Methods: Quantitative
- D) Methods: Qualitative
- E) Exhibits to Support Chapter 2
- F) Exhibits to Support Chapter 3
- G) Exhibits to Support Chapter 4

Appendix B: Conflict of Interest Statement



3 West Road | Virks Building | Cranston, RI 02920

12/6/2019

National Opinion Research Center (NORC)
4350 East-West Highway, 8th Floor
Bethesda, MD 20814

RE: Evaluator for RI Section 1115 Medicaid Waiver – No Conflict of Interest

To Whom It May Concern,

As a contractor for the Executive Office of Health and Human Services (EOHHS), NORC intends to acquire and process data for the purpose of evaluating such data for Centers for Medicare & Medicaid Services (CMS) and the State of Rhode Island. Our organization's acquisition and processing of EOHHS data does not pose a conflict of interest, as our organization performs Section 1115 Medicaid Waiver evaluation activities in the areas of claims-based analyses, monitoring, and evaluation reports.

Despite having no conflict of interest in relation to our use of EOHHS data, my organization intends to separate and secure any EOHHS data acquired through its work with the State of Rhode Island by using the EOHHS data only for the purposes of performing work under the project "RI Health System Transformation Project Evaluation." The EOHHS data will be securely stored in a project designated folder with access limited to individuals who work under the project and have need to access the EOHHS data. NORC will use internal network data storage services to store all project-related data files. Remote access to internal NORC computing resources requires two-factor authentication and encrypted channels. Only secure, encrypted file transfers will be used when transferring data files over the Internet.

The contact person for conflict of interest matters within our organization is Kathleen Parks, NORC's Vice President of Academic Research Centers and senior Institutional Review Board ("IRB") member, who serves as NORC's Compliance Officer and can be reached at Parks-Kathleen@norc.org.

Sincerely,

Adil Moiduddin
Senior Vice President, Health Care Evaluation Research



**ATTACHMENT Z:
Reserved for SUD Implementation Plan Protocol**

Introduction

The Rhode Island Department of Behavioral Healthcare, Developmental Disabilities and Hospitals (BHDDH) oversees a comprehensive array of treatment services across the full continuum of care through licensed SUD providers including outpatient services, intensive outpatient services, medication assisted treatment, intensive levels of care in residential and inpatient settings, and medically supervised withdrawal management. BHDDH oversees a wide range of other services that focus on prevention, intervention, or recovery support. These include Peer Recovery Specialists services, and non-Medicaid, grant-funded Recovery Centers and Recovery Housing. Increasing access to all levels of care, including recovery support services, is one of EOHHS' primary goals. BHDDH is currently working with a provider to develop a telephonic crisis hotline that will be operated 24 hours per day, 7 days per week, as well as a triage center and mobile outreach that will allow individuals in crisis or in need of services to be triaged to the appropriate level of care. For this to be successful, capacity for residential SUD treatment and peer services needs to be built. This is a key factor to improving rates of identification, initiation and engagement for the treatment and care of those with OUD and SUD diagnoses.

While RI is making great strides in serving individuals with SUD and OUD, there is a serious opioid crisis in the state that BHDDH, the Department of Health, Law enforcement and several other stakeholders are working to address. Figure 1 below shows that between 2007 and 2008, and between 2011 and 2012, nonmedical use of pain relievers in the past year was more prevalent in RI among 18 to 25-year-olds relative to national averages. Between 2012 and 2013, RI adults aged 26+ had higher rates of nonmedical use of pain relievers in the past year compared to national averages. However, given a steady decline, the most recent data from the period of 2013 through 2014 indicate that RI is consistent with national averages across all age groups for nonmedical use of pain relievers.

Figure 1. RI vs. US Nonmedical Use of Pain Relievers in Past Year by Age Group, 2007-2014²³

²³ Source: National Survey on Drug Use and Health (NSDUH)

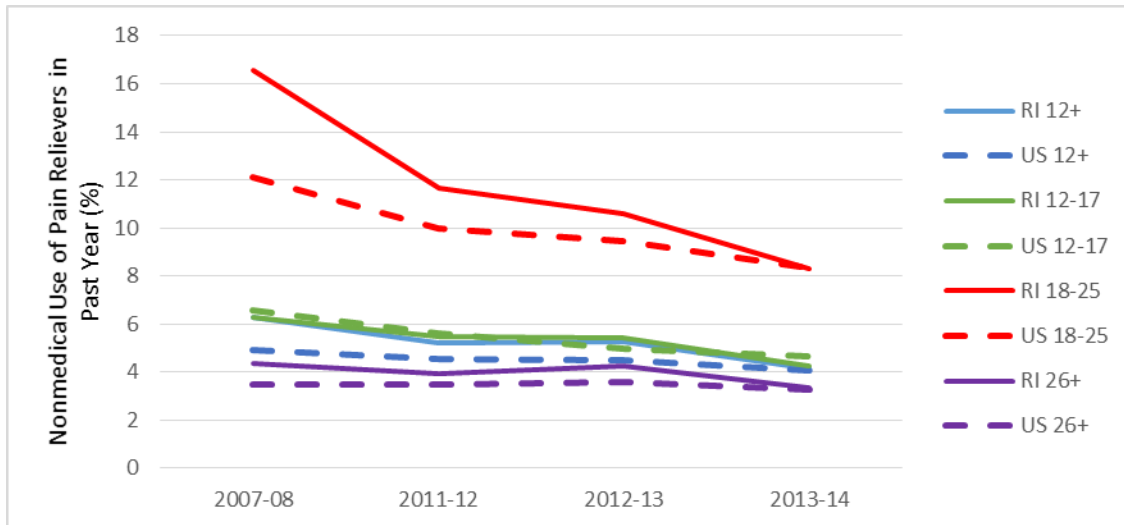

Rhode Island has experienced a 50% increase in overdose deaths between 2011 and 2016. Similar to states across the country, deaths caused by prescription drugs have leveled. RI has seen a decrease of 40% since 2011, deaths from illicit drugs have risen by 250% and deaths caused by a combination of illicit drugs and prescription opioids are up by 33% since 2011. Overdose deaths due to illicit drugs being mixed with Fentanyl have increased 20-fold since 2009 and is exacerbating the overdose crisis. As of December 12, 2016, there were 1,471 reports of overdose, of which 57 resulted in death, 1,152 had been discharged from the hospital at the time of the report and 262 had been admitted to the hospital but not discharged. Heroin was the cause of 58% of the overdoses.

Statewide, about 3 in 4 people who die of an overdose are men (70% are male and 30% are female). All age groups are affected, but most overdoses occur among adults. The highest percentage of individuals who have overdosed are between the ages of 25 and 34 (33%), followed by 35-44 (21%), 45-54 (18%), 18-24 (16%), 55-64 (8%) and 2% of the population under 18 and over 65. In addition, based on overall demographic information from the United States Census, the communities most impacted by fatal overdose are more racially and ethnically diverse than the state average.

There is a disproportion number of individuals being released from the Rhode Island Adult Correctional Institute who die from an overdose within one year of release (2014-2015). The Department of Corrections has partnered with a local SUD provider to offer MAT within the prison walls and to facilitate the continuation of these treatment post release.

The Rhode Island Overdose Prevention and Intervention Task Force, which is co-chaired by the Directors of the BHDDH and the Department of Health, has created an Action Plan to address the state's overdose crisis. The plan focuses on four strategies: prevention, rescue, treatment and recovery, and outlines a public education and community outreach plan to end the stigma of addiction. As a result of this statewide collaboration, most of the milestones required for the SUD Waiver have been achieved. However, EOHHS and BHDDH have a number of activities to undertake to ensure that Medicaid beneficiaries are provided with a full continuum of care for people with SUD and MH conditions. Increased use of Peer Recovery Specialists and the

establishment of the BH Link triage centers, hotline, and mobile outreach will be critical to improving Medicaid beneficiaries' access to care, at all levels. EOHHS and BHDDH have requested a waiver of the IMD rule for SUD to increase capacity at residential facilities. Over the next fiscal year, it is a shared goal of EOHHS and BHDDH to implement these three initiatives and to continue the current processes as described below.

Two new services that EOHHS has recently received authority for are the Recovery Navigation Program (RNP) and the Peer Recovery Specialists. The RNP is a nonclinical program that does not provide treatment but serves as an alternative setting to the Emergency Room for individuals with Substance Use Disorders. It also has staff who, if the patient chooses to, will connect these patients to treatment services. The hours of operation for this program must meet the needs of the population the vendor is choosing to serve. A Peer Recovery Specialist is a credentialed behavioral health care professional who provides an array of interventions that promote socialization, long-term recovery, wellness, self-advocacy, and connections to the community. The services focus on people with a mental health and/or substance use disorder who are having trouble stabilizing in the community and/or are in need of supports to maintain their stability in the community. This includes but is not limited to Medicaid-eligible individuals who are experiencing, or are at risk of, hospitalization, overdose, homelessness or are in the hospital after an overdose, are homeless or are in a detox setting. It would also include people recently released from institutions such as hospitals and prisons.

In the 1115 Waiver Extension Request, EOHHS requested the authority for the Behavioral Health Link Triage Center (BH Link), a 24/7 triage center providing mental health and substance use disorder treatment, medical monitoring, peer support, case management and, if needed, emergency prescribing to individuals in crisis for mental health and/or substance use disorders. BH Link services will be provided by a BHDDH-licensed Behavioral Healthcare Organization. Similar to the RNP, the intent is to provide a safe alternative to the Emergency Department but unlike RNP, BH Link can provide treatment such as motivational interviewing and other interventions to help individuals in crisis due to substance use disorders or mental health issues stabilize and then link them up to more long-term services in the community. BH Link will also manage the state's behavioral health hotlines through grant funding which provides telephonic triage and information to individuals with behavioral health issues.

Milestone #1: Access to critical levels of care for OUD and other SUDs Specifications:

To meet this milestone, the state Medicaid program must provide coverage of the following services:

- Outpatient Services;
- Intensive Outpatient Services;
- Medication assisted treatment (medications as well as counseling and other services with sufficient provider capacity to meet needs of Medicaid beneficiaries in the state);
- Intensive levels of care in residential and inpatient settings; and
- Medically supervised withdrawal management

Coverage of General Outpatient services

8. Current State:

Unless otherwise noted, the following Licensed Outpatient treatment services are authorized through the RI Medicaid State Plan and are available in all catchment areas of RI:

- Alcohol and/or drug assessment
- Behavioral health (SUD, MH and COD) individual, family and group counseling and therapy
- Intensive outpatient and partial hospitalization services
- Medication assisted treatment (MAT): Methadone maintenance, Naltrexone, Buprenorphine, and Centers of Excellence for Opioids (COE)
- Opioid Treatment Program Health Home
- Peer recovery specialists (Expenditure Authority through Comprehensive 1115 Waiver)
- Detox: ASAM Level II-D

9. Future State:

EOHHS and BHDDH are currently pursuing federal authority through its 1115 Waiver to receive federal matching funds for a Behavioral Health Link (BH Link) Triage Center and have secured grant funding to establish a hotline and mobile outreach for behavioral health crises that will operate 24 hours per day, seven days per week. Through referrals and warm handoffs, this is intended to increase access to the existing outpatient and peer services.

Coverage of Intensive Outpatient and Partial Hospitalization Treatment Services

10. Current State:

BHDDH-Licensed Intensive Outpatient and partial hospitalization treatment services are available in all catchment areas of RI and are offered to individuals assessed to need ASAM Levels 2.1 and 2.5.

11. Future State:

EOHHS and BHDDH are currently pursuing federal authority through its 1115 Waiver to receive federal matching funds for a Behavioral Health Link (BH Link) Triage Center and have secured ongoing SAMHSA block grant funding that will be sustained throughout the demonstration period to establish a hotline and mobile outreach for behavioral health crises that will operate 24 hours per day, seven days per week. BH Link services will be provided by a BHDDH-licensed Behavioral Healthcare Organization. Through referrals and warm hand-offs, this is intended to increase access to the existing intensive outpatient services. The following services will be provided at BH Link:

- Crisis Management and Stabilization
- Psychiatric Consultation Services
- Connections to Treatment, Recovery Supports, and Recovery Housing
- Clinical Assessment
- Peer Support
- System Navigation
- Mobile Crisis Response

- Care Management
- Emergency Medication Prescribing
- Continued Engagement and Connection to Follow-Up Services
- Skilled Nursing

Coverage of Medication Assisted Treatment (MAT)

12. Current State:

Currently, there are 14 Centers of Excellence for Opioid (COE) locations that help address complex MAT issues for primary care providers (similar to the Hub & Spoke model of Vermont). There are also 19 Opioid Treatment Locations (OTP) that offer Methadone, Naltrexone, Buprenorphine and OTP Health Home (see SPA TN# RI-16-006) services. There is currently no waiting list at any MAT service at any of the OTP locations, COE sites, or Prescribing Buprenorphine providers.

13. Future State:

EOHHS and BHDDH are currently pursuing federal authority through its 1115 Waiver to receive federal matching funds for a Behavioral Health Link (BH Link) Triage Center and have secured grant funding to establish a hotline and mobile outreach and inductions for behavioral health crises that will operate 24 hours per day, seven days per week. Through referrals and warm handoffs, this is intended to increase access to the existing MAT services. It is anticipated that as more Peer Recovery Specialists become trained, they will also increase access to MAT as they assist their clients in navigating the recovery process. As part of a recent award from a DLT grant application, a Train the Trainer program on Medication Assisted Recovery Support services (MARSS) for Peer Recovery Specialists will be offered free of charge to all certified peers in the state.

Coverage of intensive levels of care in residential and inpatient settings

14. Current State:

BHDDH uses the ASAM placement criteria for all BHDDH-licensed (Non-Hospital) SUD levels of care. Residential and inpatient services are offered to meet ASAM levels III.5, III.3, and III.1. There is a total of 280 residential beds in RI, 186 of which are for men, 48 for women (of these, 12 are for pre- and postpartum women and their young children), and 46 are co-ed. There are currently approximately 100 individuals waiting for placement into a residential bed. In addition to the ASAM levels of care, medically supervised withdrawal management is available throughout the state.

15. Future State:

EOHHS and BHDDH are pursuing federal authority to receive federal matching funds for members with substance use disorders (SUD) that require treatment at an Institution for Mental Diseases (IMD) to ensure that beneficiaries do not have to wait for a placement into a residential bed. This authority will allow for greater capacity, accessibility, and positive outcomes for beneficiaries. It is anticipated that this waiver authority will attract new

residential providers, which will further increase the number of available beds in the state. Using grant dollars, the state will offer startup funds for new, high-performing providers to offer these services to special populations in need. Several existing providers have shared an interest in utilizing the startup funds for new programming that would eliminate our current wait list and improve access to this level of care.

As more Peer Recovery Specialists are trained and certified, beneficiaries will receive increased support when transitioning between the various levels of care in the SUD continuum. Currently the state contracts with one provider to provide certification training several times a year as well as internship opportunities. Another provider receiving some grant funding has opted to provide training towards certification as well, which will allow us to expand the number of trainings offered and increase the number of peers certified to provide warm handoffs between levels of care. The goal is to increase the percentages of individuals connecting from one level of care to another; including MAT and recovery support services.

Milestone #2: Widespread use of evidence-based, SUD-specific patient placement criteria Specifications:

To meet this milestone, the state Medicaid agency must ensure that the following criteria are met:

- Providers assess treatment needs based on SUD-specific, multi-dimensional assessment tools, e.g., the ASAM Criteria, or other patient placement assessment tools that reflect evidence-based clinical treatment guidelines; and
- Utilization management approaches are implemented to ensure that (a) beneficiaries have access to SUD services at the appropriate level of care, (b) interventions are appropriate for the diagnosis and level of care, and (c) there is an independent process for reviewing placement in residential treatment settings.

Providers assess treatment needs based on SUD-specific, multi-dimensional assessment tools that reflect evidence-based clinical treatment guidelines

16. Current State:

The RI Division of Behavioral Healthcare at BHDDH routinely monitors and reviews all licensed behavioral healthcare programs for adherence to state Rules and Regulations for the Licensing of Behavioral Healthcare Organizations. In the Rhode Island Rules and Regulations for all Licensing of Behavioral Healthcare Organizations, Section 23.1-23.7.2 and Section 24.0 require all Licensed Behavioral Healthcare programs to screen potential clients for appropriateness and eligibility, and to use a multidimensional biopsychosocial assessment tool to identify treatment needs and interim services for the appropriate ASAM level of care. Although all providers are not required to use the same biopsychosocial assessment, all assessments that are used must include some common elements deemed critical for clinical appropriateness. These elements are clearly laid out in BHO regulation Section 24.0. Section 40.14.1 requires the utilization of the ASAM Placement Criteria for the determination of the individual's appropriate level of care.

BHDDH also requires that provider trainings utilize the ASAM National Practice Guidelines for the use of medications in the treatment of addiction involving opioid use.

17. Future State:

BHDDH will continue to monitor and review all licensed behavioral healthcare programs to ensure that they are assessing treatment needs based on a multidimensional biopsychosocial assessment tool and providing services that meet client's the appropriate ASAM level of care.

Implementation of a utilization management approach such that (a) beneficiaries have access to SUD services at the appropriate level of care

18. Current State:

EOHHS and BHDDH currently operate utilization management through a few avenues, which allows for opportunities to provide technical assistance and to monitor appropriate levels of placement. The Medicaid Managed Care Organizations (MCOs), BHDDH auditing teams, and clinical peer reviews allow for continuous monitoring and adherence to appropriate ASAM levels of placement. Utilization reviews include mental health as well as SUD programs to ensure that co-occurring disorders are properly diagnosed and treated.

19. Future State:

Managed Care Organizations will continue to provide utilization reviews and prior authorizations for all residential, IOP and partial hospital levels of care. EOHHS and BHDDH will continue to monitor and provide technical assistance to ensure quality screening and appropriate service referrals. The new BH LINK program will not only improve access to care but will also be another mechanism to determine that an individual in need of SUD treatment will be placed in the appropriate ASAM level placement.

Implementation of a utilization management approach such that (b) interventions are appropriate for the diagnosis and level of care

20. Current State:

As described above, EOHHS and BHDDH currently operate utilization management through a few avenues, including retrospective records-based reviews, which allows for opportunities to provide technical assistance and to monitor appropriate levels of placement. Behavioral Health Organization regulations require all Licensed Behavioral Health programs to screen potential clients for appropriateness and eligibility, and to use a multidimensional biopsychosocial assessment tool to diagnose individuals and identify treatment needs and interim services that meet ASAM level of care criteria. Utilization reviews include mental health as well as SUD programs to ensure that co-occurring disorders are properly diagnosed and treated. The NGO-Independent Peer Review program also has a process to review records retrospectively and to offer technical assistance as needed. The confidential reviews of each ASAM level of care receiving Block Grant funding is then written up and reviewed by the Director of BHDDH annually.

21. Future State:

Medicaid MCOs will continue to provide utilization reviews and preauthorizes this level of care and authorization. EOHHS and BHDDH will continue to monitor and provide technical assistance to ensure quality screening and assessment of individuals prior to placement in levels of care. The Independent Peer review committee will continue reviewing random samples of Block grant recipients providing treatment at all listed ASAM levels of care.

Implementation of a utilization management approach such that (c) there is an independent process for reviewing placement in residential treatment settings

22. Current State:

The Substance Abuse and Mental Health Services Administration (SAMHSA) requires all states receiving Substance Abuse Prevention and Treatment Block Grant (SAPT) funds to develop an Independent Peer Review process that assesses the efficacy, quality, and appropriateness of SUD treatment services, including placement in appropriate levels of care. BHDDH contracts with an independent entity to administer this process, which utilizes a team of clinical supervisors working in BHDDH-licensed SUD programs. Reports are submitted on an annual basis to BHDDH.

23. Future State:

BHDDH will continue to work with its Independent Peer Review contractor to ensure there is an independent process for reviewing placement in residential treatment settings.

Summary of Actions Needed:

There are no further actions needed to meet this milestone. EOHHS and BHDDH will continue current utilization management practices moving forward.

Milestone #3: Use of nationally recognized, evidence-based, SUD program standards to set residential treatment provider qualifications

Specifications:

To meet this milestone, state Medicaid agencies must ensure that the following criteria are met:

- Implementation of residential treatment provider qualifications (in licensure requirements, policy manuals, managed care contracts, or other guidance) that meet the ASAM Criteria or other nationally recognized, SUD-specific program standards regarding the types of services, hours of clinical care and credentials of staff for residential treatment settings;
- Implementation of a state process for reviewing residential treatment providers to assure compliance with these standards; and
- Implementation of a requirement that residential treatment facilities offer MAT on-site or facilitate access off site.

Residential treatment provider qualifications (in licensure requirements, policy manuals, managed care contracts, or other guidance) that meet the ASAM Criteria or other nationally recognized, SUD-specific program standards regarding the types of services, hours of clinical care and credentials of staff for residential treatment settings

24. Current State:

BHDDH used the nationally recognized, evidence-based ASAM SUD program standards to set residential treatment provider qualifications, along with SAMSHA's Treatment Improvement Protocols (TIPs) #45 and the ASAM National Practice Guidelines for the use of medications in the treatment of addiction involving opioid use. The provider qualifications and requirements for Residential Services are identified in Section 40.0 of the Rhode Island Rules and Regulations for the Licensing of Behavioral Healthcare Organizations. Regulations include staffing ratios, credentials, and minimal hours of clinical care.

All licensed residential providers are contracted with the MCOs and must meet their requirements for staff qualifications and hours of service, which typically align with the rules and regulations established by the state. Residential services, screenings, and assessments for appropriate level of care are available 24 hours per day, 7 days per week. Residential staff are required to meet staff credentialing and appropriate level of clinical supervision, as defined in state regulations. Technical assistance is provided by BHDDH at the time of auditing. In addition, BHDDH improves residential levels of care quality through required training in ASAM levels of care and the use of SAMHSA TIP 45.

25. Future State:

Coaching, mentoring, and training on co-occurring disorders, funded by the State Innovation Model (SIM) grant, will be provided to support an informed and educated workforce with the goal of working to improve recognized evidence based practices to fidelity. Providers will continue to be required to use ASAM to determine what services are appropriate for their clients and to provide those needed services. Technical assistance will continue to be provided during reviews to adhere to SAMHSA TIP 45 and other publications on providing quality care in all SUD treatment settings. Licensed behavioral healthcare providers will continue to use ASAM National Practice Guidelines for the use of medications in the treatment of addiction involving opioid use. BHDDH staff will continue to monitor staffing through quality audits and HR reporting.

State process for reviewing residential treatment providers to assure compliance with these standards

26. Current State:

BHDDH regularly conducts licensing audits and operates a direct telephone line, 24 hours per day, seven days per week, to log complaints and reports of incidents related to its behavioral healthcare system. When these complaints are deemed significant a formal investigation is conducted. Some of these investigations result in a required action from the provider ranging in severity from submission of, and compliance with, a corrective action plan, to the loss or suspension of license and potentially the closure of the program. BHDDH provides ongoing technical assistance and education to providers to ensure compliance with the qualifications and to reduce the need for regulatory action.

27. Future State:

BHDDH will continue to operate the telephone line, regularly conduct audits, and provide support and training to providers. BHDDH will continue to track information from these processes to establish state trends and patterns.

Residential treatment facilities offer MAT on-site or facilitate access off site

28. Current State:

All facilities in Rhode Island are contractually required to provide and coordinate MAT services either on-site or have a Memorandum of Understanding (MOU) with a provider that does so on their behalf.

29. Future State:

BHDDH will continue the contractual requirements and regularly audit, review, support and train on MAT. MAT peer recovery specialist will be imbedded in residential programming to assist with MAT coordination and education.

Summary of Actions Needed:

There are no further actions needed to meet this milestone.

Milestone #4: Sufficient provider capacity at each level of care, including MAT Specifications:

To meet this milestone, state Medicaid agencies must complete an assessment of the availability of providers enrolled in Medicaid and accepting new patients in the critical levels of care listed in Milestone 1. This assessment must determine availability of treatment for Medicaid beneficiaries in each of these levels of care, as well as availability of MAT and medically supervised withdrawal management, throughout the state. This assessment should help to identify gaps in availability of services for beneficiaries in the critical levels of care.

Completion of assessment of the availability of providers enrolled in Medicaid and accepting new patients in critical levels of care throughout the state

30. Current State:

MAT outpatient services and intensive outpatient services are available without any wait throughout the state. There are currently over 12,000 people on MAT. Residential services have a current wait list and identified underserved areas have been targeted for future growth. There is currently no wait list for Medically Supervised Withdrawal Management utilizing MAT.

31. Future State:

Utilizing the State Opioid Response (SOR) grant funds, BHDDH will release Requests for Proposals to support the startup of new SUD residential treatment facilities for women and dependent children, a male facility for those with co-occurring disorders and a gender-specific ASAM level III.1 for transitional males. This is intended to increase the capacity to serve these populations and reduce the length of waiting lists for residential treatment.

BHDDH will continue to support trainings available on ASAM National Practice Guidelines for the use of medications in the treatment of addiction involving opioid use. BHDDH will also provide a Train the Trainer Medication Assisted Recovery Service training to Peer Recovery

Specialists. Through contract performance measures, BHDDH receives quarterly reports on the current trained provider pool for Peer Recovery Specialists.

Summary of Actions Needed:

Capacity for gender specific residential SUD treatment must be increased. The IMD waiver will allow some larger SUD residential treatment providers to assist the state in alleviating some of the access challenges that RI faces for these particular levels of care (ASAM III.1 – III.5).

Milestone #5: Implementation of comprehensive treatment and prevention strategies to address opioid abuse and OUD

Specifications:

To meet this milestone, state Medicaid agencies must ensure that the following criteria are met:

- Implementation of opioid prescribing guidelines along with other interventions to prevent prescription drug abuse;
- Expanded coverage of and access to naloxone for overdose reversal; and
- Implementation of strategies to increase utilization and improve functionality of prescription drug monitoring programs.

Opioid prescribing guidelines along with other interventions to prevent prescription drug abuse

32. Current State:

State regulations require all residential and MAT facilities to review the Prescription Drug Monitoring Program (PDMP) prior to admission. The Rhode Island Department of Health (RIDOH) has implemented all opioid prescribing guidelines and oversees the PDMP. Key attributes of the PDMP are mandatory reporting of all retail and institutional pharmacies dispensing 25 prescriptions or more in a month; reporting requirements pertain to drugs in Schedules II-IV; mandatory enrollment of all practitioners; 72-hour data collection interval; unsolicited reports to prescribers, pharmacists, law enforcement and licensing boards with the release of information authorized for law enforcement officials, licensing/regulatory boards, patient or parent of minor child, prescribers and dispensers; and mandatory access for all opioid treatment programs prior to a patient's advancement to a new take home phase. All eligible prescribers are compliant with the regulation requiring registration with the PDMP.²⁴

33.

Additionally, there are several controls that EOHHS has implemented to minimize the risk of inappropriate opioid overprescribing, including:

- The preferred drug list where long acting opioids are non-referred agents;
- Editing in the claims processing systems which will only allow for refills after 85% of the days' supply of the point of service (POS) claim has passed;

²⁴ ²⁴ <http://www.namsdl.org/prescription-monitoring-programs.cfm>; retrieved 4/30/2016.

- Editing in the claims processing system which communicates to the pharmacist at POS when there is therapeutic duplication and requires intervention from the pharmacist before the claim will process;
- Claims processing support of RI legislation that limits opioid naïve patients to 20 doses or 30 morphine milligram equivalents at POS; and
- Retrospective utilization review initiatives look for opioid use in combination with other medications, diagnosis and prescribers.

The following interventions to prevent prescription drug use are also being implemented through a federal CDC Prescription Drug Overdose Prevention for States Grant and Supplement to the Department of Health:

Enhance and Maximize the PDMP:

- Top prescribers receive in office academic detailing from a Department of Health employee who is dedicated to PDMP and opioid prescribing education efforts.
- Annually two CME events are offered by RIDOH on responsible prescribing topics.
- A Clinical Alert feature was added to PDMP to identify risky prescribing patterns. Prescribers receive a notification if a patient has a combination of an opioid and benzodiazepine prescription, has been on an opioid for longer than 90 days, or has a prescription from more than four prescribers and filled prescriptions at more than four pharmacies during a six-month period.
- Integration into EHRs have been piloted to integrate PDMP into EHRs and pharmacy systems.

Community/Data Interventions:

- Drug Overdose data is publicly available on a dashboard website. (www.preventoverdoseRI.org)
- A multidisciplinary Drug Overdose Death Review Team is convened quarterly to identify possible future interventions to prevent additional overdose deaths.
- Paid media campaigns messaging. Addiction is a Disease and Recovery is Possible have expanded statewide. Naloxone data collection, training, storage, and distribution has occurred statewide. There is no current sustainable way to purchase Naloxone in RI.
- A law enforcement pilot program in West Warwick connects people to treatment/recovery services in lieu of criminal justice involvement. There is an embedded clinician within the West Warwick Police Department who does community outreach, training on substance use disorder to the department, and is able to respond to with police officers to calls related to substance use.
- The BHDDH peer recovery specialist program has been expanded into DOC, street outreach, and ED.
- BHDDH Support Line availability was expanded to offer services 24 hours' day/7 days a week.

Policy Evaluation:

- Evaluation of four policies relevant to drug overdose has been conducted and guides future programmatic decisions.

Rapid Response:

- Mini-grants (\$5,000) are available quarterly to community-based organizations to implement data driven, education or prevention interventions based off of the recommendations of the death review team.

CDC Enhance Opioid Overdose Surveillance Grant

- Extract medical examiner cases of overdose death and enter into national, standardized reporting system: Violent Death Reporting System
- Improve timeliness of 48-hour overdose reporting system and ME data
- Improve EMS drug overdose data

BJA Harold Rogers PDMP grant

- Develop, implement, and evaluate online, interactive training course on identifying women of child bearing age that may have opioid use disorder

34. Future State:

Continue to defer to RIDOH to monitor PDMP. Auditors will review records to ensure PDMP reviews are occurring at licensed BHOs in all their programs treating mental health and SUDs.

Expanded coverage of and access to naloxone for overdose reversal

35. Current State:

One of the four (4) strategies within the Governor’s Overdose Intervention and Prevention Task Force is to expand coverage and access to Naloxone. BHDDH and RIDOH developed a Naloxone distribution plan using the RI Medical Corp to help get the Naloxone out to high-risk areas and has been doing so since 2016 using a variety of grants to fund its purchase and distribution. RI has a timely distribution plan of getting naloxone to area “Hotspots” by utilizing Peer Recovery Specialists in a Mobile Outreach Recovery Effort program called “MORE”. Every Wednesday, peers are dispatched to areas that have high numbers of non-fatal and fatal overdoses that are reported in from the 11 local hospitals.

36. Future State:

BHDDH and RIDOH will utilize the State Opioid Response (SOR) grant and State Targeted Opioid Response (STR) grant to continue to purchase and manage the distribution of Naloxone throughout the State in high risk areas and to first responders and others who come in contact with those in need.

Implementation of strategies to increase utilization and improve functionality of prescription drug monitoring programs.

37. Current State:

RIDOH has implemented all opioid prescribing guidelines set forth by the CDC and is the Department that oversees the PDMP program. RIDOH has piloted EHR integration of PDMP into EHRs and pharmacy databases through the state Health Information Exchange (HIE). Other efforts are described in more detail in the SUD Health IT Plan.

38. Future State:

RIDOH will continue providing academic detailing on the PDMP and prescribing guidelines to prescribers identified as being out of compliance with prescribing regulations or guidelines, and RIDOH will continue to expand integrations as referenced in the SUD Health IT Plan.

Summary of Actions Needed:

RIDOH will encourage large healthcare systems and pharmacy chains to utilize the PDMP EHR Integration option through the HIE and will continue to pursue strategies to make Naloxone distribution or availability sustainable to first responders and others who may need it.

Milestone #6: Improved care coordination and transitions between levels of care Specifications:

To meet this milestone, state Medicaid agencies must implement policies to ensure residential and inpatient facilities link beneficiaries, especially those with OUD, with community-based services and supports following stays in these facilities.

Policies to ensure residential and inpatient facilities link beneficiaries with community-based services and supports following stays in these facilities

39. Current State:

RI has taken strides to provide care coordination for physical health by implementing the Opioid Treatment Program Health Homes. Additionally, the implementation of Centers of Excellence for Opioids improved care coordination between physical health, mental health and MAT services.

40. Future State:

Through contracts with providers, BHDDH will encourage the use of Peer Recovery Specialists trained in Medication Assisted Recovery (MARs) to reside in residential placements in order to assist clients in their transition plans between levels of care by providing transportation and warm hand offs. For example, Peers will either accompany or contact individuals leaving residential treatment on MAT to ensure they get to their first outpatient MAT appointment as well as helping them navigate the broader nonclinical recovery support systems in their local communities. BHDDH is also expanding funding to recovery centers throughout the state to enhance community connections for those in recovery.

Summary of Actions Needed:

BHDDH needs to work with providers to focus attention on their client's needs for community support and integration when they are discharged from outpatient, MAT and residential programs.

Implementation Administration

Questions regarding Rhode Island's SUD Implementation Plan should be directed to:

Linda Mahoney, Administrator and State Opioid Treatment Authority (SOTA)

401-462-3056

Linda.mahoney@bhddh.ri.gov

Relevant Documents

The Governor's Overdose Prevention Action Plan is available at <http://preventoverdoseri.org/our-action-plan/>. This website is an initiative of the Rhode Island Governor Gina Raimondo's [Overdose Prevention and Intervention Task Force](#), in collaboration with the Rhode Island Department of Health ([RIDOH](#)), the Rhode Island Department of Behavioral Healthcare, Developmental Disabilities and Hospitals ([BHDDH](#)), and Brown University [School of Public Health](#).

Attachment A: SUD Health Information Technology (IT) Plan

Overview:

Rhode Island is well-positioned to support and monitor the efforts of this waiver with existing health information technology infrastructure at all levels. Rhode Island has relatively high electronic health record adoption, and a statewide Health Information Exchange, CurrentCare. There are numerous activities underway that will continue to enhance the state's technical infrastructure. Further detail on the initiatives described below is provided in the Relevant Documents section:

- **State Innovation Model (SIM) Grant Health Information Technology activities:**
 - Healthcare Quality Measurement Reporting and Feedback System – A statewide centralized electronic clinical quality measurement reporting and feedback system which will import electronic health record data from providers across the state, calculate a wide range of quality measures, and report the results at the provider, practice, ACO, and hospital level back to the providers, as well as send reports to payers and other organizations as requested by providers. This system will also be capable of calculating more advanced hybrid (claims and clinical) quality measures as they evolve.
 - EOHHS Data Ecosystem – Centralized and modern health and human services data warehouse for aggregating data sets, modeling data, and self-service reporting for state employees through the analytic platform Power Business Intelligence (Power BI). The Ecosystem is enabling state analysts to be able to better understand how Rhode Islanders interact with state government services, and could be used to help make PDMP data more accessible for data analysis. The EOHHS Data Ecosystem is being built off of the state's All Payer Claims Database, known as HealthFacts RI. Work is already underway using this data to evaluate the differences in cost and utilization for individuals diagnosed with OUD before and after receiving MAT.
 - Consumer Engagement Platform – Centralized document repository and form delivery system connected to the HIE which will enable patients or provider care teams to use a web-based interface to share patient-generated data or to complete forms. This will initially allow for the upload of advance directives and completion of social determinants of health screening tools. Planning is already underway to add SBIRT screenings, and other forms or screenings can be added in the future.
 - Care Management Dashboards – RI SIM funded the implementation of Care Management Dashboards at all Community Mental Health Organizations in the state. These dashboards provide a real-time status of patients being admitted to or discharged from acute-care hospitals (emergency department and inpatient). These dashboards have

also been implemented at all Opioid Treatment Programs in the state through another funding source.

- **HITECH IAPD activities:**
 - **RI's Health Information Exchange (CurrentCare)** is supported through a multi-payer PMPM contribution, including RI Medicaid and the RI State Employees health plan, to sustain and enhance the statewide HIE. RI's HIE is opt-in, meaning individuals must consent to have their data collected as well as shared by the HIE. Policies and procedures exist to enable sharing of 42 CFR Part 2 data through an additional consent process at the Part 2 covered facility. Data from Part 2 covered facilities is stored separately and redisclosure language is displayed prior to accessing Part 2 data from the HIE.
 - **HIE-Enabled Overdose Prevention Project** is a 5-component initiative to further enhance the HIE to combat the opioid crisis. The specific components include:
 - Emergency Department Smart Notifications to easily identify those at risk for SUD/ODU disorder and frequent ED use
 - Integration of EMS Data into the HIE
 - SBIRT Platform (Integrated into the SIM Consumer Engagement Platform)
 - PDMP/EHR Integrations
 - Intelligent Overdose Alert to notify providers of potential overdose upon admission to ED or use of EMS services
- **HealthFacts RI, RI's All Payer Claims Database (APCD)** – The Medicaid All Payer Claims Database is a module of RI's Medicaid Enterprise System. Per state law, all payers with at least 3,000 members must contribute medical and pharmacy claims, provider files, and eligibility files to the APCD. The data are aggregated and direct identifiers are removed. The APCD is used to support multi-payer data analytics to better understand cross-system utilization and incidence of disease.

Rhode Island has sufficient health IT infrastructure at every appropriate level to achieve the goals of the demonstration.

While not all of the above activities are specifically part of the SUD Health IT Plan, many of the activities will help to support the implementation of the SUD Health IT Plan. This SUD Health IT Plan is aligned with the State Medicaid Health IT Plan (SMHP), and will help to further enhance RI's overall technical infrastructure and capacity to evaluate the impact of the demonstration over the duration of the demonstration period.

As with all HIT investments, the state will continue to assess the applicability of the standards referenced in the ISA and 45 CFR 170 Subpart B and use appropriate mechanisms to ensure relevant standards are used. These methods may include, for example, inclusion in vendor contracts, inclusion in legislation or regulation, and/or inclusion in Medicaid Managed Care contracts.

The specific milestones to be achieved by developing and implementing a SUD Health IT Plan include:

- Enhancing the health IT functionality to support PDMP interoperability; and

Enhancing and/or supporting clinicians in their usage of the state's PDMP. Prescription Drug Monitoring Program Functionalities

Criterion 1: Enhanced interstate data sharing in order to better track patient specific prescription data

41. Current State:

The RIDOH PDMP is a member of the National Association of Boards of Pharmacy's (NABP) PDMP Interconnect, which links Rhode Island to other member-state PDMPs to facilitate interstate sharing of dispensing information. As of July 2018, RIDOH PDMP is connected with 20 states for patient-specific prescription data sharing within the PDMP.

42. Future State:

Continue to use the NABP PDMP Interconnect to make connections with as many other state PDMPs as possible. The RIDOH PDMP Data Manager has been in contact with 10 additional state PDMP administrators and one additional state is expected to connect by the end of 2019. Please note that there are major barriers to connecting with many others states, and that RIDOH has reached agreement with all readily willing states. Some of these barriers include other state PDMPs existing in different departments (i.e. law enforcement rather than health), different state laws in place to determine who may see PDMP data (i.e. RI allows delegates to view data as well, while in some states that is prohibited), different state policy on which states they will be willing to connect with (i.e. only bordering states), and differing state security protocols and concerns. It is anticipated that connecting with the remaining states will be more onerous than it was to connect to the 20 that are already in place.

Criterion 2: Enhanced “ease of use” for prescribers and other state and federal stakeholders

43. Current State:

There are numerous activities currently underway to help both prescribers and pharmacists more easily use data from the PDMP. EOHHS/Medicaid in coordination with the RIDOH PDMP program has contracted with RI's State Designated HIE entity, the Rhode Island Quality Institute (RIQI) to facilitate the integration of PDMP data with EHRs for prescribers and pharmacists. This was piloted and has gone live in RI's largest hospital system, Lifespan. Additionally, an alert feature was added to the PDMP in May of 2017 to notify prescribers when a patient has a potentially dangerous prescription (i.e., co-prescription of opioid and benzodiazepine and MME over 91) or has been to five (5) or more prescribers and five (5) or more pharmacists in a 6-month period. Lastly, RIDOH contracted with a PDMP vendor, Appriss, to work with CVS (which accounts for about 50% of all pharmacies in RI) to directly integrate PDMP data with CVS's pharmacy system. CVS began testing the new integration in March 1, 2018 and went live in all CVS stores in August of 2018.

44. Future State:

EOHHS and the RIDOH PDMP program will continue to work with the RIQI to implement additional PDMP-EHR integrations, and offer this opportunity to those practices/providers/pharmacies in Rhode Island that are interested and capable of having their EHR or pharmacy system support a PDMP integration. This EHR integration option will increase utilization of the PDMP by both providers and pharmacists by making it easier to access, reduce

the time it takes out of the workflow to check the PDMP, and making it more intuitive and integrative to use.

45. Summary of Actions Needed:

EOHHS' HIT Specialist will work with RIDOH to develop a PDMP EHR Integration Fact Sheet which will inform providers about the value, opportunity and steps needed to connect their EHR through the HIE to the PDMP. The fact sheet will be distributed through the PDMP website and through the RIDOH Health Connections newsletter in late 2018. Additionally, RIQI will reach out to the other hospital systems and a number of provider practices, prioritizing the largest group practices and those seeing a large number of Medicaid beneficiaries, to solicit interest and identify EHR technical capabilities. EOHHS and RIDOH will work with RIQI to complete at least three additional EHR integrations by the end of 2019. The success of this activity is contingent upon identifying three additional health care entities interested in this integration effort and having their EHR vendor technically capable and willing to implement this integration through the HIE.

Criterion 3: Enhanced connectivity between the state's PDMP and any statewide, regional or local health information exchange

46. Current State:

As stated above, the RIDOH PDMP is currently connected to RI's Health Information Exchange infrastructure operated by RIQI using the Appriss API method. The API allows for data to be passed in real time through the HIE to the EHR without being stored at the HIE, and also allows for full audit data to be recorded in the PDMP database.

47. Future State:

RIDOH will continue the connectivity between the PDMP and the Health Information Exchange using the API method, as well as add an additional method of integration through the HIE (NCPDP). The NCPDP method will allow for sharing of PDMP data with EHRs that may not be capable of using the API method, and will also allow for the use and storing of PDMP data within the HIE. The NCPDP method is less ideal because it does not allow for an automated logging and audit function to store use data in the PDMP database, which is critical for maintaining compliance with the state law. In order to accommodate these requirements, additional design will be required to support auditing and reporting functions through the HIE.

48. Summary of Actions Needed:

EOHHS and RIDOH will work with RIQI and Appriss to implement a NCPDP connection through the HIE by June 30, 2019, which will allow the storing of PDMP data for patients who have consented to participate in CurrentCare, or for use in the HIE Enabled Overdose Prevention Project described previously. As stated above, EOHHS HIT staff and the RIDOH PDMP Data Manager will continue to work with RIQI to implement several additional PDMP/EHR data integrations based on the interest and readiness of hospital and provider practices.

Criterion 4: Enhanced identification of long-term opioid use directly correlated to clinician prescribing patterns

49. Current State:

RIDOH's PDMP Data Manager can run some limited reports of clinician prescribing patterns within the Appriss product. These reports have been used to reach out to clinicians and provide academic detailing about the prescribing of opioids.

50. Future State:

The PDMP database will be fully modeled, integrated with and available through the EOHHS Data Ecosystem. The EOHHS Data Ecosystem is newly developed integrated data system which links data sets from across EOHHS agencies to enable self-service analytics for operations and performance management in a user-friendly manner to nimbly assess and respond to changing policy and operational needs while controlling total costs. By linking PDMP data with Medicaid claims data through the EOHHS Data Ecosystem and by using the APCD, EOHHS data analysts in coordination with the PDMP Data Manager will be better able to assess clinician prescribing patterns as it relates to long-term opioid use.

51. Summary of Actions Needed:

EOHHS and RIDOH already have a data sharing agreement in place to allow for the incorporation of the PDMP data into the EOHHS Data Ecosystem. Analytic projects using the EOHHS Data Ecosystem are proposed to the EOHHS Ecosystem Governing Board which is made up of EOHHS Agency Directors or their designees. RIDOH and EOHHS will propose the development of PDMP dashboards and reports within the EOHHS ecosystem's Power BI tool to track long-term opioid use and correlations to clinicians to support the ability to pursue targeted outreach. Assuming this project is approved by the Governing Board in 2019, the PDMP data will be integrated into the EOHHS Data Ecosystem, and the EOHHS Analytics team will work with the RIDOH PDMP Data Manager to develop a series of dashboards and reports within the Power BI tool to track long-term opioid use and correlations to clinicians to support the ability to pursue targeted outreach.

Current and Future PDMP Query Capabilities

Criterion 5: Facilitate the state's ability to properly match patients receiving opioid prescriptions with patients in the PDMP (i.e. the state's master patient index (MPI) strategy with regard to PDMP query)

52. Current State:

53. The ability to match patients receiving opioid prescriptions with patients already in the PDMP occurs using the PDMP vendor's (Appriss) patient matching algorithm. Matching for some patients that may show up in the PDMP can be especially complex, since high risk patients may have multiple aliases.

It is important to note that RI does not have one central statewide master patient index across its integrated databases. Several different systems such as the APCD, HIE and PDMP and each

have their own built in MPI implemented by each respective vendor. The EOHHS Data Ecosystem also has its own MPI across the state agency databases that are part of this system. Currently when a user looks up a patient in the PDMP that may match multiple records, all records are viewable for the user. It is then up to the user to open each potential record, consider if they reflect one or multiple patients, and combine the prescription history together to make a treatment plan. This is not ideal for the workflow, but better than hiding the records, because with a mismatch the entire record is still available to the user.

54. Future State:

RIDOH will continue to operate using the PDMP vendor's unique patient identification algorithm and when the PDMP is incorporated into the EOHHS Data Ecosystem, EOHHS and RIDOH will identify the match rate and may be able to explore whether the EOHHS Data Ecosystem's ability to match patients can provide additional matching support to the PDMP. It is important to note because the matching algorithm in the EOHHS Data Ecosystem is for analytic purposes and not patient care, it may not be as strict, since some mismatches are acceptable in an analytics environment.

55. Summary of Actions Needed:

Pursuant to approval by the EOHHS Data Ecosystem Governing Board as described in Criterion 4, EOHHS's Deputy Director of Analytics and RIDOH's PDMP Data Manager will collaborate to assess the performance of the existing matching algorithm and determine if there is any opportunity to improve the matching process in the PDMP by using the MPI in the EOHHS Data Ecosystem, and develop a recommendation. Additionally, the EOHHS HIT Specialist will work with the PDMP Data Manager and RIQI staff to analyze the number of ambiguous matches that occur when sending a query from EHRs through the HIE infrastructure to the PDMP, and identify if opportunities exist to use the HIE matching process to improve the PDMP.

Use of PDMP – Supporting Clinicians with Changing Office Workflows / Business Processes

Criterion 6: Develop enhanced provider workflow / business processes to better support clinicians in accessing the PDMP prior to prescribing an opioid or other controlled substance to address the issues which follow

56. Current State:

All controlled substance prescribers, OTP and SUD residential treatment providers are required by regulation to check the PDMP prior to prescribing, and on an annual basis thereafter, or as needed. OTP and SUD residential treatment providers are also required to check the PDMP at admission, prior to considering MAT take-home status changes, and at minimum every 3 months. As stated in Criterion 2, the Lifespan hospitals worked with RIQI to integrate accessing the PDMP through their EHR through the workflow of prescribing an opioid.

Providers/stakeholders would also like to be able to query the PDMP any time during a visit through an easily accessible link or button, but this capability is not yet available through the Lifespan integration into their Epic EHR.

Knowing that Emergency Department (ED) providers are especially concerned and challenged in treating patients that may be at risk for SUD/OD and opioid overdose, EOHHS is currently

working with RIQI. on the implementation of the ED Smart Notifications (EDSN) project to identify ED patients immediately upon admission who are at risk of opioid use disorder or opioid overdose and/or have a high 7- and/or 30- day ED visit history. This effort will be piloted with the state's largest hospital system, Lifespan, so that when a patient registers at any of three of the Lifespan EDs, an ADT registration will be sent to RIQI, RIQI will run a predictive algorithm (currently being developed) which will include querying the PDMP in real time, as well as querying RIQI's care management ADT database (which includes ADTs from all RI Hospitals) and the HIE to determine if the patient is at risk. For those patients identified to be at risk, RIQI will send a risk flag along with summary information related to the risk (i.e. patient had >91 MME, check the PDMP) to be displayed in the EHR's ED track board (ED patient list). This will dramatically improve the workflow of ED clinicians when treating at-risk patients. The EDSN project will help deliver important data in real time to the ED clinicians without them having to take the time and effort to search for information across the EHR, HIE, and PDMP.

57. Future State:

BHDDH and RIDOH will continue existing requirements for providers to check the PDMP. In an effort to ensure that all EHR integrations meet the identified workflow needs, EOHHS, RIDOH, and RIQI will work with provider organizations to ensure that when the PDMP is integrated into the providers' EHRs, the integration supports, where technically feasible, both checking the PDMP as part of the prescribing controlled substance workflow as well as at any time during a visit.

The EDSN will be implemented in all adult, acute emergency departments for the 2 largest hospital systems contingent upon the second hospital agreeing to participate.

58. Summary of Actions Needed:

EOHHS' HIT Specialist has reached out to Lifespan to request that both components of the integration are configured per the stakeholder feedback. The addition of a readily accessible button to check the PDMP at any time during a visit is already being tested for a go live this year. Additionally, EOHHS' HIT staff (HIT Specialist and State HIT Coordinator) will work with RIQI to ensure all future EHR integrations include both workflow components unless there is a major issue with the technical feasibility of doing so due to the partner's EHR vendor. Lastly, EOHHS's HIT staff will work with RIQI to launch the EDSN product in all Lifespan adult emergency departments and initiate work with one other interested hospital in 2019.

Criterion 7: Develop enhanced supports for clinician review of the patients' history of controlled substance prescriptions provided through the PDMP—prior to the issuance of an opioid prescription

59. Current State:

60. All controlled substance prescribers, OTP and SUD residential treatment providers are required by regulation to check the PDMP prior to prescribing and on an annual basis thereafter, or as needed. Additionally, OTP and SUD residential treatment providers are required to check the PDMP prior to or at admission prior to considering MAT take-home status changes, and at minimum every 3 months. The PDMP patient report has several features which make review of the prescription history easier to read, including some key data at the top to help quickly identify risk of dangerous prescriptions (i.e. MME, number of prescribers, number of pharmacies). These

same indicators are also present in the patient report that is delivered through the pilot EHR integration with Lifespan.

61.

62. Future State:

BHDDH and RIDOH will continue existing requirements for providers to check the PDMP. The key indicators will continue to be supplied at the top of the PDMP report for ease of use for prescribers. As discussed in Criterion 6, EOHHS and RIQI will work together to ensure that the PDMP query can occur effortlessly in the prescribing workflow for future EHR Integrations.

63. Summary of Actions Needed:

EOHHS HIT staff will work with RIQI to ensure all future EHR integrations include a prescribing workflow component unless there is a major issue with the technical feasibility of doing so due to the partners' EHR vendor.

Criterion 8: Enhance the master patient index (or master data management service, etc.) in support of SUD care delivery.

64. Current State:

SUD care delivery and care coordination is currently supported in part by sharing data through RI's statewide HIE, CurrentCare. In addition to patients needing to enroll in CurrentCare (consenting to have their data sent to CurrentCare and consenting to whom it can be shared with, see Relevant Documents section), patients who receive care at 42 CFR Part 2 covered facilities can provide an additional consent at that site permitting their data from the Part 2 covered facility to be sent to CurrentCare and stored separately. CurrentCare data can then be accessed by authorized CurrentCare users who choose to check to see if the patient has any Part 2 data and after having reviewed required redisclosure language. This allows other treating providers to be aware of the patient medical history and treatment provider at other SUD and/or health care delivery sites.

In addition to this, RIQI operates several Care Management Services using the HIE infrastructure. For these services, under business associate agreements, RIQI obtains all ADT transactions from all RI acute care hospitals. Practices choosing to subscribe to RIQI's Care Management services then provides a list of all active patients they would like to track relative to ED and hospital admissions and discharges. RIQI will notify practices when their patients are admitted to or discharged from a RI ED or hospital regardless of whether the patient has consented to participate in CurrentCare. The two major services under this arrangement are Care Management Dashboards (real time dashboards of patient ED/hospital use) and Care Management Alerts (alerts delivered by Direct messaging about ED/hospital use). All OTPS and Community Mental Health Organizations in the state currently subscribe to these services which help to support coordination of care, especially since SUD treatment providers rarely receive communication from the hospitals about their patients.

All HIE services (Care Management as well as CurrentCare) run data through the HIE's Master Patient Index to ensure that health information from multiple sources can be aggregated into a longitudinal record for the patient. This matching algorithm has a very high success rate.

65. Future State:

To ensure that data can be shared appropriately to impact the delivery of SUD services, the following future state is envisioned:

- All SUD treatment sites have applicable staff provisioned, and trained to actively use CurrentCare to review medical history on enrolled patients
- All SUD treatment sites promote consent to participate in CurrentCare and the consent for 42 CFR Part 2 data sharing through CurrentCare to their patients
- All SUD treatment sites contribute data on consented patients to CurrentCare where their EHR capability exists.
- All SUD treatment sites continue to subscribe to Care Management Services to receive timely ED/hospital utilization data
- Department of Corrections enrolls patients in CurrentCare and shares data with CurrentCare.

66. Summary of Actions Needed:

EOHHS HIT staff will work with RIDOH staff and BHDDH staff to incorporate into the State's 2019 HIE contract with RIQI the following provisions:

- RIQI will provision and train all applicable users for access to CurrentCare data at SUD treatment sites
- RIQI will ensure all SUD treatment sites have the tools and training to offer enrollment in CurrentCare to all patients, and where applicable, manage the consent for sharing of 42 CFR Part 2 data with CurrentCare
- RIQI will establish data feeds from all non-connected SUD treatment sites to CurrentCare, where readiness and EHR capability exists
- RIQI will establish data feeds from the Department of Corrections EHR when readiness and capability exists

EOHHS through the Medicaid MCOs and BHDDH through regulatory oversight will request that all SUD treatment sites commit to the following through the demonstration period:

- Encourage all SUD treatment sites to use CurrentCare, and encourage them to incorporate use of CurrentCare Viewer for medical history into the workflow
- Encourage providers to offer enrollment to CurrentCare and, where applicable, consent for sharing of 42 CFR Part 2 data through CurrentCare

The milestones anticipated for 2019 are as follows:

- All SUD treatment sites who have agreed to sign the data use agreement are able to access CurrentCare
- All SUD treatment sites offer enrollment to CurrentCare at check-in
- All SUD treatment sites that contribute data to CurrentCare ask for additional consent for sharing of 42 CFR Part 2 data where applicable
- Additional two SUD treatment sites succeed with establishing a new interface to share data with CurrentCare assuming EHR vendor readiness and capabilities exist
- All SUD treatment sites continue to maintain Care Management Services subscriptions

- Department of Corrections data feed to CurrentCare is live and operational assuming readiness and capability exists

Overall objective for enhancing PDMP Functionality & Interoperability

Criterion 9: Leverage the above functionalities / capabilities / supports (in concert with any other state health IT, TA or workflow effort) to implement effective controls to minimize the risk of inappropriate opioid overprescribing – and to ensure that Medicaid does not inappropriately pay for opioids

67. Current State:

68. In addition to the activities and functionalities that are described above, there are several controls that EOHHS has implemented to minimize the risk of inappropriate opioid overprescribing, including:

- The preferred drug list where long acting opioids are non-referred agents;
- Editing in the claims processing systems which will only allow for refills after 85% of the days' supply of the point of service (POS) claim has passed;
- Editing in the claims processing system which communicates to the pharmacist at POS when there is therapeutic duplication and requires intervention from the pharmacist before the claim will process;
- Claims processing support of RI legislation that limits opioid naïve patients to 20 doses or 30 morphine milligram equivalents at POS; and
- Retrospective utilization review initiatives look for opioid use in combination with other medications, diagnosis and prescribers.

69. Future State:

EOHHS continues the claims system controls and leverages a fully modeled PDMP database, integrated with and available through the EOHHS Data Ecosystem. By linking PDMP data with Medicaid claims data through the EOHHS Data Ecosystem and by using the APCD, EOHHS data analysts in coordination with the PDMP Data Manager will be better able to assess clinician prescribing patterns as it relates to long-term opioid use. This information will provide EOHHS with the information it needs to determine whether there are additional controls that need to be implemented.

70. Summary of Actions Needed:

RIDOH and EOHHS will propose the development of PDMP dashboards and reports within the EOHHS ecosystem's Power BI tool to track long-term opioid use and correlations to clinicians to support the ability to pursue targeted outreach to the EOHHS Ecosystem Governing Board. Assuming this project is approved by the Governing Board in 2019, the PDMP data will be integrated into the EOHHS Data Ecosystem, and the EOHHS Analytics team will work with the RIDOH PDMP Data Manager to develop a series of dashboards and reports within the Power BI tool to track long-term opioid use and correlations to clinicians to support the ability to pursue targeted outreach.

Implementation Administration

The state's point of contact for the SUD Health IT Plan is:

Amy Zimmerman, State HIT Coordinator

401-462-1730

Amy.zimmerman@ohhs.ri.gov

Relevant Documents

- [Rhode Island State Innovation Model \(SIM\) Test Grant Operational Plan, April 25, 2018](#)
- [CurrentCare Guidebook](#)

Attachment B - State Medicaid Health Information Technology Plan 2017



State Medicaid Health Information Technology Plan
SMHP Update

Submitted: February 10, 2017

SMHP REVISION HISTORY

Date	Author	Version	Change Reference
June 28, 2011	Whitridge Assoc.	Draft 1.0	
July 12, 2011	Whitridge Assoc.	Final 1.0	
November 16, 2011	Whitridge Assoc.	1.1	Incorporated CMS Suggested changes
December 3, 2014	EOHHS	Update	Flexibility Rule Addendum submitted and approved
February 9, 2016	EOHHS	Update	2015-2017 Modified Meaningful Use Addendum submitted and approved
February 10, 2016	EOHHS	Draft 2.0	

Table of Contents

State Medicaid Health Information Technology Plan	344
SMHP REVISION HISTORY	345
A. Current HIT Landscape – The “As-Is” Assessment.....	349
A.1 Extent of EHR Adoption	349
A.2 Broadband & Internet Access.....	358
A.3 Rhode Island FQHC HIT Landscape & HRSA Funding Streams for HIT.....	359
A.4 Indian Health Center & Veterans Administration	359
A.5 Key Stakeholder State Government Organizations Impacting Health IT.....	359
A.5.2 Rhode Island Department of Health.....	362
A.6 HIT/E Relationships with Other Key Stakeholder Entities.....	365
A.7 Health Information Exchange Organization.....	368
A.8. State HIT Coordinator	375
A.10. State Laws and Regulations.....	377
A.11. HIT/HIE Activities that Cross State Borders	378
A.12. State Immunization Registries & Public Health Surveillance Databases	378
A.13. State HIT-Related Grants	380
B. To-Be Assessment – The Future HIT/HIE Landscape.....	382
B.1. Five Year Vision Overview.....	382
B.2. HIT Future Initiatives (includes several beginning to be implemented).....	382
C. Administrative Oversight of the EHR Incentive Program.....	397
C.1. Verification of Eligible Providers	397
C.2. Calculating Patient Volume	400
C.3. Verifying Patient Volume	406
C.4. Alignment of Data Collection and Analysis Processes	411
C.5. IT Timeframe for Systems Modifications	412
C.6. Interface with the CMS NLR.....	413
C.7. Accepting Registration Data from the CMS NLR.....	413
C.8. Websites for Enrollment and Program Information	413
C.9. Anticipated Modifications to the MMIS	413
C.10. Call Centers/Help Desks	413
C.11. Appeals & Administrative Redetermination	414
C.12. Assuring that Federal Funding is Accounted for Properly	414
C.13. Anticipated Frequency of EHR Incentive Payments.....	415
C.14. Role of Existing Contractors with Implementation	420
C.15. Assumptions.....	420
D. Audit Strategic Plan	421
D.1. Audit Methods	421
D.2. Identification and Tracking Overpayments	427
D.3. Fraud and Abuse Mitigation.....	427
D.4. Leveraging Existing Data Sources	428

D.5. Sampling Methodology..... 428
D.6. Reducing Provider Burden 429
D.7. Program Integrity Operations 430
E. Medicaid HIT Roadmap..... 432
E.1. Where we are today and where we expect to be in Five Years..... 432
E.2. Expectations for EHR technology and HIE Adoption Over Time with Annual Benchmarks..... 434
E.3. Benchmarks for Audit and Oversight Activities..... 434

Executive Overview – Background & Purpose

The Centers for Medicare and Medicaid Services (CMS), as part of the provisions of the American Recovery and Reinvestment Act of 2009, have set forth requirements that states must meet in order to qualify for 90% Federal matching funds for administration of their Medicaid EHR Incentive Programs. This document, the Rhode Island State Medicaid HIT Plan (SMHP), represents one of these key requirements. The document describes the State of Rhode Island's current and future Health IT activities, as well as the path or 'roadmap' to their attainment, in support of the Medicaid EHR Incentive Program. In accordance with CMS guidelines, this SMHP is comprised of five main sections:

- A. HIT Landscape Assessment – The 'As-Is' Environment
- B. HIT Future Vision – The 'To-Be' Environment
- C. Activities Necessary Administer and Oversee the Medicaid EHR Incentive Program
- D. The State's Audit Strategy
- E. The State's HIT Roadmap

Using the above sections as a framework, the document describes the State's current planning with respect to payment administration, meaningful use, adopt/implement/upgrade considerations, eligibility, and financial oversight/program integrity.

This 2.0 version is an update to Rhode Island's SMHP which was submitted in November 2011 and approved by CMS in June 2012. It includes program changes approved during the last quarter of 2015, as well as program additions being requested in RI's IAPD-U which was submitted in December 2016 which are in process of being reviewed by CMS. It should also be noted that Rhode Island has participated in the 13 State MAPIR Collaborative since the start of the Medicaid EHR Incentive program. Rhode Island's MAPIR system has been processing applications since June 2011 and made its first Rhode Island Medicaid EHR Incentive payment in September 2011. Since then, and as of end of December 2016, the program has paid 1,294 applications with a total of \$35m distributed to Rhode Island Medicaid eligible providers and hospitals.

The diagram on the following page depicts the progress we have made with providers participating in the program and how far along they are with meeting meaningful use.

RI Medicaid EHR Incentive Payment Breakdown as of December 31, 2016

	Count	Total	EP Count	EP	EH
Paid for Adopt	90	\$2,609,092	90	\$1,834,586	\$774,506
Paid for Implement	162	\$3,350,421	162	\$3,350,421	\$0
Paid for Upgrade	358	\$8,415,387	358	\$7,387,925	\$1,027,462
Total Paid Yr 1 AIU	610	\$14,374,899	610	\$12,572,932	\$1,801,967
Yr 1 Paid MU	28	\$7,074,716	21	\$425,002	\$6,649,714
Yr 2 Payments for Meaningful Use - Stage 1	322	\$9,168,817	314	\$2,567,013	\$6,601,804
AIU > MU Conversion Rate	57%		55%		
Yr3 Payments for Meaningful Use Stage 1	196	\$3,265,716	188	\$1,544,173	\$1,721,543
Yr3 Payments for Meaningful Use Stage 2	3	\$22,667	3	\$22,667	\$0
MU Yr2 > MU Yr3 Conversion Rate	62%		61%		
Yr4 Payments for Meaningful Use Stage 2 & Flexibility	97	\$793,337	97	\$793,337	\$0
MU Yr3 > MU Yr4 Conversion Rate	49%		51%		

A. Current HIT Landscape – The “As-Is” Assessment

A.1 Extent of EHR Adoption

The Rhode Island Medicaid EHR Incentive program has well exceeded its initial estimate of the number of eligible providers that were going to enroll in the program and adoption and meaningful use a certified electronic health record. At the beginning of the EHR Incentive Program, we estimated that 10% (300) of the approximately 3,000 eligible providers in the state would participate, because of the 30% Medicaid patient volume threshold. Since 2016 is the last year to enroll in the program we are now estimating that 23% (700) of the state’s eligible providers are participating in the Medicaid EHR Incentive Program in Rhode Island.

As of December 2016, our state has 930 providers participating in the Medicare EHR Incentive and 632 participating in the Rhode Island Medicaid EHR Incentive program. Rhode Island has a total of 1,562 providers earning an EHR Incentive payments, which shows that providers are accepting HIT as a tool to aid the practice of medicine. This demonstrates that a large number of the state’s providers are making the effort to move toward meaningful use.

Rhode Island has eleven acute care hospitals throughout the state, of which nine are participating in both Medicare and Medicaid programs and one could only participate with the Medicare program because they lacked the 10% Medicaid patient volume requirement. Meanwhile, another hospital in our state was in receivership for several years and was recently acquired by a national healthcare organization. We have been in contact with the hospital to determine if they qualify to participate with the program and encourage them to attest for program year 2016 before the March 30, 2017 deadline.

A1.1.1 FQHC and EHR Adoption

In Rhode Island nine out of ten FQCH organizations are participating in the Rhode Island Medicaid EHR Incentive program. These nine organizations have 29 practice locations throughout the state and serve our neediest individuals with medical dental and behavioral health

care services. As a result of FQHC participation, 43% of all eligible providers participating in the Rhode Island Medicaid EHR Incentive program are FQHC providers. As noted, FQHC providers are actively taking part in RI's EHR's incentive program as evidenced by the some of the metrics listed below:

- 89% of the FQHC providers participating have attested to Meaningful Use and are active in the program.
- Of all the EP payments made as of December 31, 2016, FQHCs have earned \$8.7m from the Rhode Island Medicaid EHR Incentive program. That amount covers 25% of what was disbursed to all providers including eligible hospitals and 48% of all eligible providers.
- An FQHC organization was the first to attest to meaningful use for Dentists in our state in 2015.

A1.2 State HIT/HIE Self-Assessment Survey Results

With direction from the Department of Health and the Executive Office of Health & Human Services, HealthCentric Advisors (HCA) is contracted to perform a bi-annual survey of how healthcare providers are utilizing their EHR and the state's health information exchange known as CurrentCare within their practice operations. The objective of the survey is to measure the overall trends associated with HIT adoption and use and more specifically to identify how clinicians use technology while caring for patients, what the greatest barriers are, what will help to enable increased use. The survey was last conducted in 2015, and the data was analyzed in 2016. Additionally, based on survey results and the evolving landscape, the intent is to modified the survey and administer it again in the spring of 2017.

The survey is electronically administered to all RI licensed independent practitioners (LIPS) such as physicians, physician assistants and advanced practice registered nurses (a.k.a. nurse practitioners). The 2015 survey was changed to add patient engagement questions and measures that would evaluate basic and advanced EHR usage.

As can be seen in the graph below, the 2015 HIT Survey response rate remained steady with at least two thirds of our physician population completing the survey.

The HIT Survey has a relatively high response rate for a single-wave mailed survey. It is higher among physicians than APRNs/PAs.



Response rate by year (administration to APRNs/PAs began in 2013)

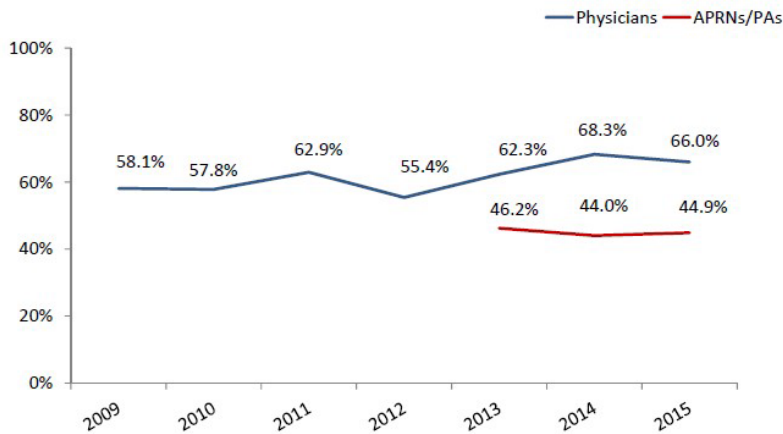

Last updated 9/22/2015

This survey measured EHR usage among those who responded, but we also calculate a combined measure of the responders and non-responders using the assumption that non-responders had not adopted HIT. The intent of reporting providers who do not respond to the survey as not using an EHR was to help incentivize providers to fill out the survey since this information is publically reported on the Department of Health's website. Despite that we know this combined measure is a gross underestimate of EHR adoption and that there are providers with EHRs that do not respond to the survey. This is confirmed by other data points (see Inventory results). Given that it is increasingly clear many non-respondents have adopted EHRs, we may want to eliminate reporting on the combined measure.

Despite the different measures of adoption, it is clear that HIT in the state is becoming integrated into provider's practices. Close to 90% of the providers participating in the survey indicated they have an EHR and close to 82% are e-prescribing with their EHRs.

The 2015 results provide a point-estimate of HIT adoption among physicians for the four publicly-reported measures.



Use of EHRs and e-prescribing, among respondents and all physicians

Measure	Survey Respondents (N=2,572)		All Physicians (N=3,898)	
	Population	Score	Population	Score
1. Physicians with EHRs, n (%)	2,572	2,290 (89.0%)	3,898	2,290 (58.8%)
2. EHR functionality use (0-100), median	2,290	75.0	--	--
3. Patient engagement EHR use (0-100), median	2,290	35.7	--	--
4. Physicians who are e-prescribing, n (%)	2,377	1,944 (81.8%)	3,703	1,944 (52.5%)

Non-respondents were reported as NOT using health information technology

Last updated 9/22/2015

2015 was the first year we measured the use of the EHR for patient engagement, and found that 35.7% were using their EHR in this way. The survey also showed that EHR and e-prescribing usage has steadily increased over the past six years.

Adoption of EHRs and use of e-prescribing have been increasing since 2009. EHR adoption increased by nearly 31.6% and e-prescribing by 98.5%.



Survey respondents' use of EHRs and e-prescribing

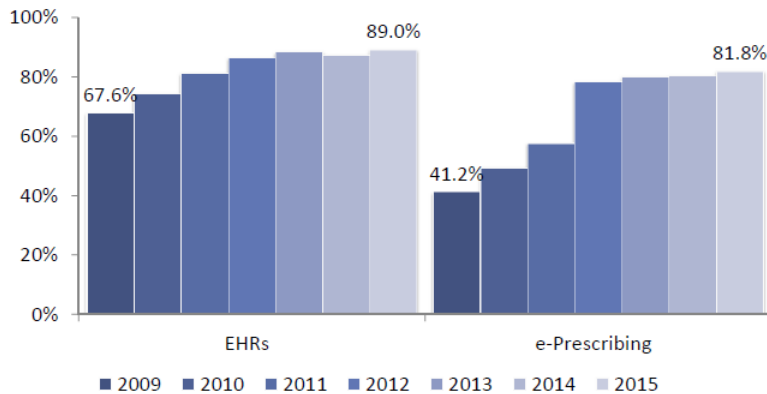

Last updated 9/22/2015

A1.3 Physicians Utilizing EHRs for Population Health Management

Survey questions were not specific to every meaningful use or clinical quality measure, but touched upon basic population health functions and clinical quality measures that most EHRs had to offer. The diagram below shows to what degree our providers believe they are using their EHR for population health.

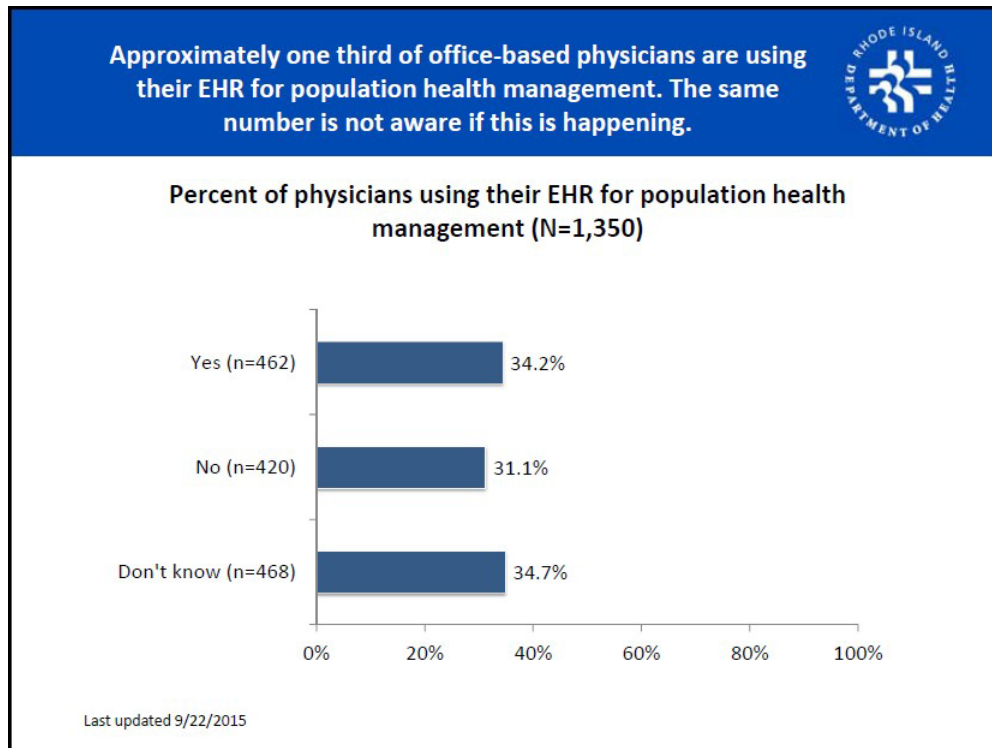

Among those who responded to this question, close to 35% indicated that they are using their EHR for population health, an increase of 7.8% since 2014. In addition, those who did not know if they were using their EHR for population health decreased by 7.1% which indicates that there is a shift in the delivery system toward recognizing population health and to managing patient populations with EHR technology.

One of the goals of the physician survey was to identify providers' ability to utilize the EHR for tracking quality measures and population health. Less than half of respondents were utilizing their EHR to monitor quality, population health, and patient reminder messaging. Our hope is that these amounts will increase in the years to come.

Tracking quality measures and sending patient reminders are among the most common ways that office-based physicians use their EHRs for population health management.



Percent of physicians who use their EHR to...

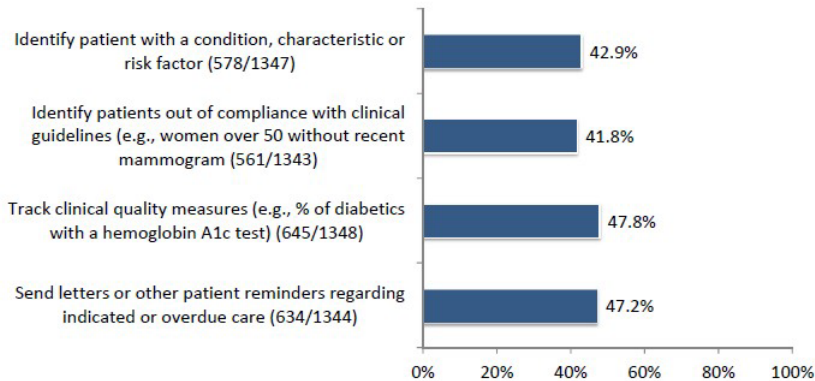

Last updated 9/22/2015

We also measured the barriers preventing providers from using their EHR for population health. The primary reason was that they felt they needed additional staff or financial support to embark on this effort.

Among those not using their EHR for population health management, almost half say that they would need additional staff or financial support to do so.



Percent of physicians who thought it would take the following for them to use their EHR for population health management... (N=1,307)

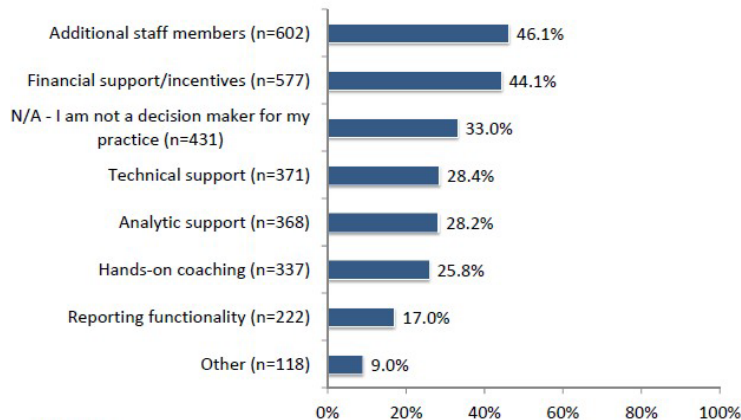

Last updated 9/22/2015

In this same survey we found that 63% of office based practices utilize a website to communicate general practice information and education. Only 16.5% of the office-based and 12.6% of hospital-based providers reported having a “Direct” message email address. We suspect this metric is under-reported based on the fact that 55.7% of office-based providers and 61.9% of hospital-based providers did not know whether they had a Direct message address.

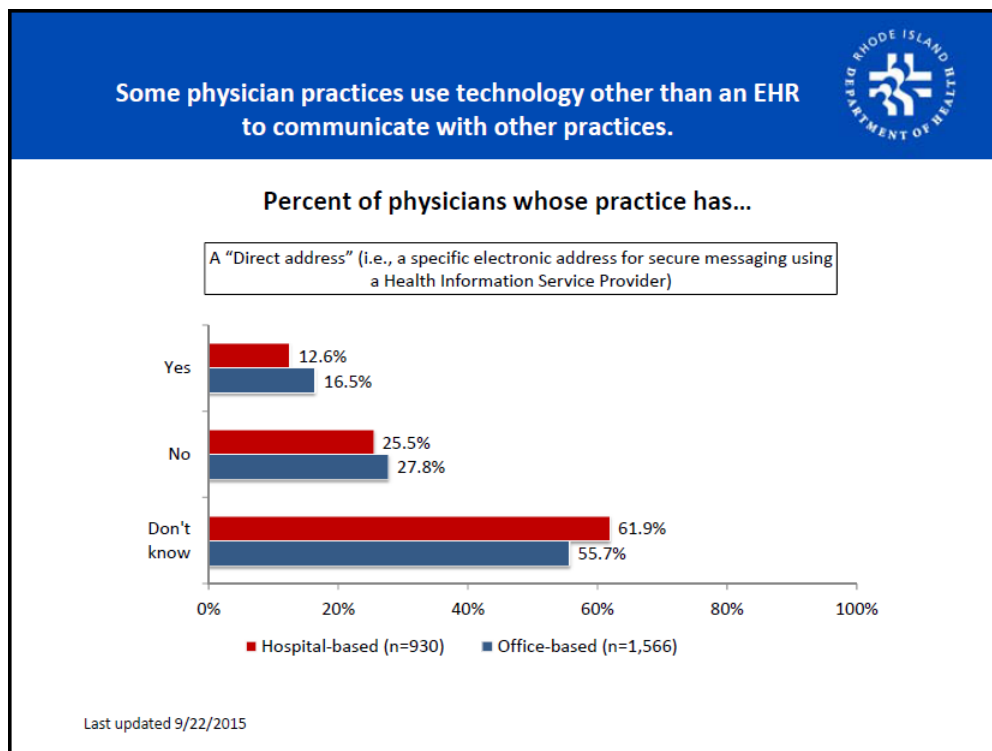

Providers were also asked how they most frequently communicated with their patients. Seven method of communication were listed including: Telephone, US Mail, Patient Portal, Email, Fax, Text Messaging, and Video Calling/Conferencing. Although 93% of the providers indicated they communicated with their patients via telephone; 24.4% also indicated that they utilize a patient portal to communicate with their patients.

A1.4 Physicians Utilizing HIE

The HIT Survey also queried respondents about how they utilize the HIE (CurrentCare) and their knowledge of available HIE services. Office-based primary care physicians had a much higher HIE utilization rate compared to office-based non-primary care physicians. This was expected since the initial HIE marketing efforts were focused heavily on primary care practices. It is anticipated that specialists’ knowledge and use of the HIE will improve in the next survey, because the HIE organization (RIQI) which also served as the Regional Extension Center, received a Transforming Clinical Practice Initiative grant which is focused on helping over 1,000 RI specialists prepare for value based purchasing in health care. As part of RIQI’s work with

specialists, they are educating and working to engage the specialists in using the HIE services available in the state.

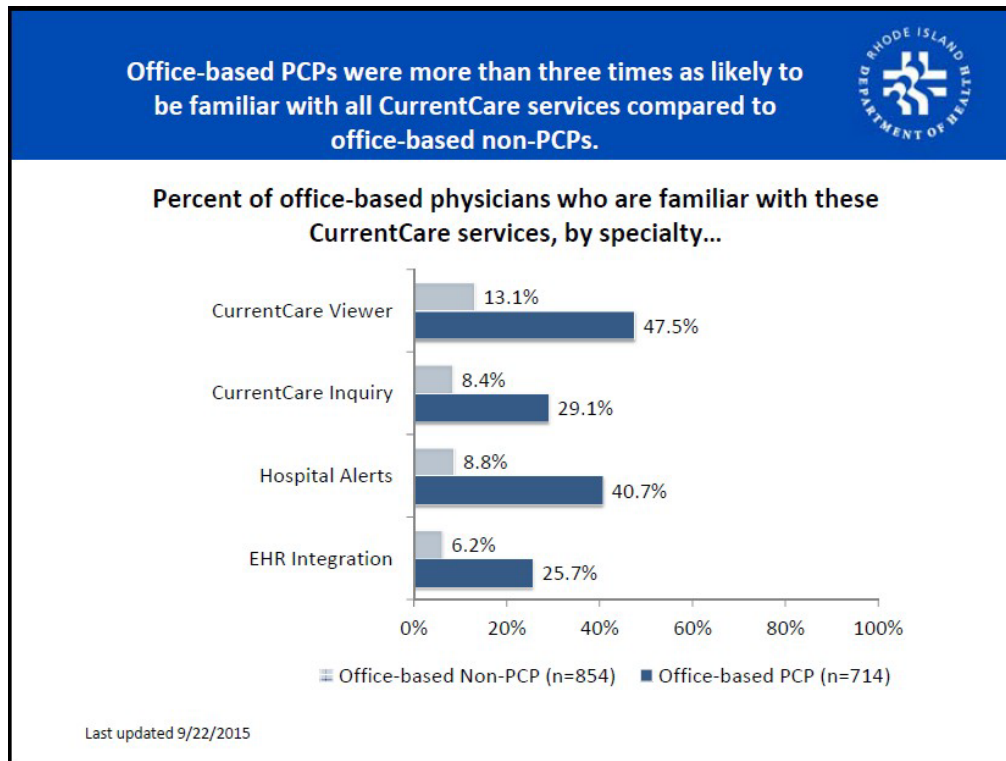

The survey also indicated that there was no increase in the familiarity with HIE services from 2014 to 2015. This clearly indicates a need to revitalize the marketing and outreach efforts around the HIE services that exist in the state.

The CurrentCare Viewer is a Web-based portal that provides up-to-date clinical information for consented patients from CurrentCare’s data-sharing partners. Patients' records include lab test results, medication history, imaging results, problem list and diagnosis, vital signs and other data points recorded in a CCD, as well as information about physician, hospital and emergency room visits. The CurrentCare Viewer gives providers access to a rapidly expanding clinical database where practices can access a patient’s latest health history to help make the best possible, most informed decisions at the point of care and reduce duplicative testing.

In addition, CurrentCare Hospital Alerts provides real time notification to primary care providers and care teams when a patient is admitted to, discharged from, or transferred within an emergency department or hospital. Hospital Alerts allow for timely follow-up care that can help improve outcomes, reduce costly re-admissions, and strengthen the patient-provider relationship.

CurrentCare/EHR Integration occurs at some practices and allows for data from CurrentCare to be shared with the provider directly through their EHR. The advantage of this is that the

provider does not have to leave the EHR workflow to view CurrentCare data. RIQI works with both the EHR vendors as well as provider organizations in determining and prioritizing if and when a provider organization's EHR can share data with CurrentCare.

Survey results indicate that almost 30% of RI's office based providers know about the features of CurrentCare. It will be important to address this metric and focus on increasing awareness and knowledge of the benefits HIE services can provide to providers and the patients they serve.

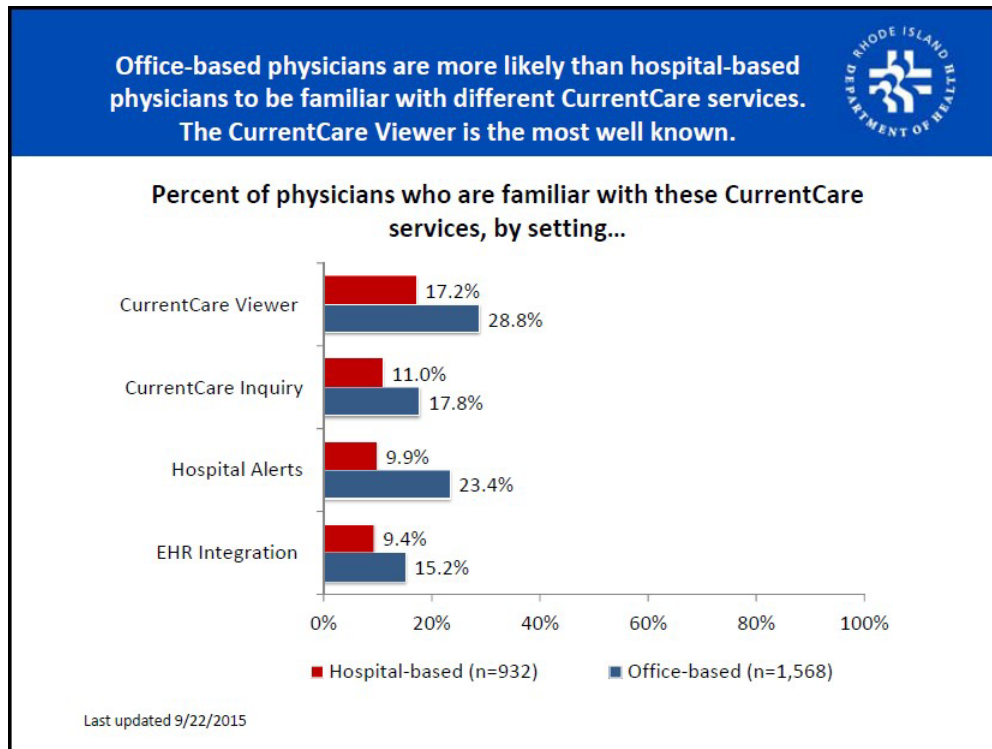

A1.5 Statewide Healthcare Inventory Survey performed by RIDOH

In 2015 the RIDOH conducted a Statewide Healthcare Inventory Survey as part of a legislative initiative to better understand the healthcare system in Rhode Island. This survey was designed in collaboration with the HIT Survey described previously in an effort to ask the right questions of the right people and reduce the burden of surveys conducted by state agencies. Whereas the HIT survey is meant for licensed independent practitioners to respond to, the statewide healthcare inventory is most often filled out by the office manager. A key component of the inventory was HIT adoption and use, and the inventory was able to collect indicative information about HIT use in facilities and practices of all types.

Paired with the HIT Survey, the inventory results can be used as a basis for our roadmap for how Rhode Island can improve HIT adoption rates. According to the first health care inventory

survey which was administered also in 2015, Rhode Island’s EHR adoption across hospitals was 92.3%, across outpatient specialty locations was 72.7%, and across primary care locations was 82.6%. It is clear that while Rhode Island’s average EHR adoption rate across all locations was 77.2%, which is close to the national average of 78%, efforts to increase EHR adoption need to be focused on specialists and behavioral health facilities or providers. Additionally, these rates align more with the HIT survey rates of survey respondents. The table shows EHR adoption rates by location type, illustrating the gaps in EHR adoption rates.

EHR Adoption Rates, Statewide Healthcare Inventory, 2015

Survey	Total Locations	Response Rate	EHR Adoption Rate
Hospital	13	100%	92.3%
Nursing Facility	89	100%	80.9%
Outpatient Specialty	418	60%	72.7%
Primary Care	311	94.5%	82.6%
Behavioral Health	48	79.2%	39.6%
Psychologists	108	88.9%	33.3%
Psychiatrists	49	100%	24.5%
Notes: Not all respondents answered the EHR adoption questions; there is possible overlap between the outpatient specialty and psychologists survey results; and some outpatient specialty practices are co-located with hospitals.			

A.2 Broadband & Internet Access

In general, given the high population density, compact size, and urban nature of the State, access to broadband services within Rhode Island is excellent. A number of recent initiatives have served to foster adoption and access. According to Broadband RI (BBRI), broadband is available for 97% of the state of Rhode Island. However, in the most urban areas 29% of Rhode Islanders do not subscribe to the Internet.

From 2010 – 2014, \$4.52 million of federal funding went to establish the Broadband RI (BBRI) initiative with the Rhode Island Economic Development Corporation (RIEDC). BBRI works to create new opportunities by expanding broadband use and digital literacy across Rhode Island. BBRI programs address public awareness and education about broadband and develop plans to increase broadband adoption and usage.

Also with federal support, OSHEAN (Ocean State Higher Education Economic Development and Administrative Network) is deploying 389 miles of high-speed optical fiber throughout the state and Ocean State Libraries is adding 600 new computers and 12 mobile computing labs to the state’s public computing resources.

A.3 Rhode Island FQHC HIT Landscape & HRSA Funding Streams for HIT

There are eight FQHC grantees in Rhode Island which serve 152,000 patients, of which 56.8% are covered by Medicaid. 100% of the FQHCs have EHRs and 88% are PCMHs.

Rhode Island does not have a recipient of the July 2016 Health Center Controlled Network (HCCN), but the FQHCs did receive Delivery System Health Information investments (DSHII) awards in September 2016 for \$509,026 to support HIT investments to support value-based care.

A.4 Indian Health Center & Veterans Administration

The Narragansett Indian Health Center is the single IHC in the State. The IHC has adopted certified EHR technology in 2012 for two providers. Since then, the two providers have left the IHC, but they continue to utilize the certified EHR Technology with the providers hired through a contractor. Their plan is to hire a full time physician, and continue to utilize certified EHR technology and eventually become meaningful users of their certified EHR.

The Veterans Administration operates a medical center in Providence. The medical center delivers a broad range of services in medicine, surgery, and behavioral sciences and is currently operating 73 beds. The medical center has approximately 150 board certified physicians and a total of 1038 full-time equivalent employees who complete the health care delivery team of professional, technical, administrative, and support personnel. Veterans can also avail themselves of primary care and some specialty services at the VA Community-Based Outpatient Clinics in Middletown, RI.

RIQI has been working with the Veterans Administration around the sharing of health information given there are a number of patients who are treated both within the VA system and by community providers. HIE data from CurrentCare is currently available to the VA providers through the current care viewer. RIQI has also successfully completed the Department of Veteran's Affairs (VA) certification testing to access VA data in a federated manner. The ability to access VA data through CurrentCare is expected to be fully implemented in the next month. Additionally, RIQI is working with the VA to allow VA data to be persisted, in order that RI providers that access CurrentCare data from within their EHRs, can also access the VA data.

A.5 Key Stakeholder State Government Organizations Impacting Health IT

Over the past five years, the state of Rhode Island has made a substantial investment in the advancement of health information technology (HIT) and, as a result, has made significant progress in planning, designing, and implementing healthcare information technology initiatives to improve the quality, safety, and value of healthcare. HIT has been and remains an identified healthcare priority for the Governor, the state's Secretary for Executive Office of Health and Human Services (EOHHS), Director of Health (DOH), the Health Insurance Commissioner (OHIC), and the state's Medicaid Director. In 2015, Governor Gina M. Raimondo, along with

Senator Sheldon Whitehouse, launched the Governor’s Working Group for Healthcare Innovation, a statewide initiative to innovate healthcare by improving patient care and health outcomes, and lowering cost for all Rhode Islanders. The diagram below summarizes the goals of this initiative. Additional details can be found at: <http://governor.ri.gov/initiatives/healthcare/>



A.5.1 Rhode Island Executive Office of Health & Human Services

The Executive Office of Health and Human Services (EOHHS) serves as the State Medicaid Agency (SMA) for the State of Rhode Island and is the umbrella organization that oversees and manages publicly funded health and human services in Rhode Island. As part of this role, EOHHS is directly responsible for Medicaid as well as some healthcare innovation initiatives such as SIM Model Test Grant initiatives, Integrated Care initiatives, Medicaid Provider and Beneficiary Oversight, Care Management, and fiscal reporting and oversight. EOHHS has contracted with Hewlett-Packard Enterprise Services (HPE) to provide Medicaid MIS deployment and support and Medicaid claims processing services. In addition, Neighborhood Health Plan and United Health Care serve as Medicaid’s managed care organizations and serve approximately 90% of Medicaid beneficiaries.

The Executive Office of Health and Human Services is driving several initiatives to ensure that Rhode Islanders -- especially our most vulnerable populations -- have access to high quality health and social services that are affordable and sustainable.

While the Affordable Care Act has helped cut Rhode Island’s uninsured rate in half, rising healthcare costs remain a concern for Rhode Island families, businesses, taxpayers and healthcare providers. Rhode Island is building on the strong foundation established by the [Working Group to Reinvent Medicaid](#) to spark innovation across our healthcare system to improve patient care and health outcomes, and lower costs for all Rhode Islanders. In 2015, [Governor Raimondo](#)’s Working Group for Healthcare Innovation, chaired by Health and Human Services Secretary Elizabeth Roberts, developed [recommendations](#) to improve the state’s healthcare system, support better health outcomes, lower costs and provide businesses with more predictability.

That same year, EOHHS received a \$20 million State Innovation Model (SIM) Test Grant to implement and test its State Health Care Innovation Plan. As part of SIM, Rhode Island has developed a population health plan based on the results of community health assessments, including the integration of primary care and behavioral health. In addition, the state will fund the following projects to support practice transformation and state data infrastructure needs, as agreed upon by the SIM Steering Committee:

- Community Health Teams
- Child Psychiatric Access Program
- Patient Centered Medical Home (PCMH) Kids program
- Behavioral Health Transformation
 - SBIRT training and screening
 - Integrated Behavioral Health Program with Patient Centered Medical Homes
 - Community Mental Health Center practice transformation
- Healthcare Quality Measurement Reporting and Feedback System
- State Data Ecosystem
- Statewide Common Provider Directory
- HealthFacts RI – RI’s All-Payer Claims Database
- Patient Engagement Tools/Advanced Illness Care Initiative

Additional details on the SIM projects are in the SIM Operational Plan, available at: <http://www.eohhs.ri.gov/Portals/0/Uploads/Documents/State%20Innovation%20Model/RISIMOperationalandIHPPlan.pdf>

The SIM grant is helping the state to augment its HIT infrastructure by supporting the continuing development of an all-payer claims database, developing a statewide common provider directory, a statewide healthcare quality measurement reporting and feedback system, patient engagement tools, and EOHHS data ecosystem.

Rhode Island’s SIM Steering Committee requested that a SIM Technology Reporting Workgroup be created to determine whether to fund a statewide quality measure reporting and feedback system. The group assessed clinical quality measurement reporting capabilities within our state, which were relatively low as also evidenced by the HIT survey. The workgroup developed a recommendation to the SIM Steering Committee to proceed with establishing a statewide clinical quality measurement reporting and feedback system. The Steering Committee approved the project, and EOHHS will be issuing an RFP in early 2017 to identify a vendor. The SIM Technology Reporting Workgroup will reconvene to serve as the governance committee for this system responsible for protecting patient privacy and defining additional business requirements. This system is being built based on an aligned set of clinical quality measures to be used by payers in contracting along with other measures that need to regularly be reported on by providers. There was a concerted effort to include the meaningful use measures in the aligned measure set, though they do not fully overlap. Additionally, this system will be built in a manner

in which it can be used by providers to meet their attestation to meeting the Meaningful use clinical quality measures.

The Rhode Island All Payer Claims Database (APCD), HealthFacts RI, is jointly managed by the Executive Office of the Health and Human Services, the Department of Health, the Office of the Health Insurance Commissioner, and HealthSource RI. The APCD collects and stores payer enrollment data, medical claims, pharmacy claims, and provider data on a monthly basis. The APCD will be used to ensure transparency of information about the quality, cost, efficiency, and access of Rhode Island's healthcare delivery system with a special focus on Medicaid access monitoring. SIM funding has established the foundation of the APCD which has allowed us to understand the breadth of the value for Medicaid operations as a primary user of the APCD.

Rhode Island has taken extensive precautions to protect patient privacy, while ensuring that the data is still longitudinal and useful to agencies, legislators, and researchers.

- No patient names, social security numbers or addresses are available in the database – to anyone. A specialized vendor, which is firewalled from the state, assigns individuals a scrambled unique identifier that cannot be traced back to identifying information.
- Publicly available data on the HealthFacts RI website will include only high-level summaries of key public health facts deemed safe for release by the Department of Health and as stipulated by regulations. No one will be able to identify individuals from this data.
- In order for non-state employees to have access to sensitive fields or individual claims, they must sign privacy agreements that prevent publication of identifiable data. In addition, requests must get approval from the state's Data Release Review Board, which reviews requests that could potentially identify individuals.
- All eligible residents were notified of their right to opt-out of the database, completely and permanently. Only 2% of people chose this option. Historical data (2011-2013) for about 130,000 people were automatically removed because these people had either moved, become uninsured, died, or were otherwise unable to be contacted.

In addition to the activities described above, the EOHHS, as the State Medicaid Agency, has primary responsibility for state-level funding, staffing, and oversight related to the development of this State Medicaid HIT Plan (SMHP), Implementation Advance Planning Document (IAPD) annual or as needed updates, as well as the administration of the Medicaid EHR Incentive Program described in Section C in this document.

A.5.2 Rhode Island Department of Health

The Rhode Island Department of Health (DOH) provides critical oversight and liaison functions that ensure alignment of the State's HIT/EHR initiatives with strategies, policies, and clinical guidelines established at the state government level. In this role, DOH works closely with

EOHHS, the State's designated RHIO known as Rhode Island Quality Institute, and other entities such as HealthCentric Advisors who advise on health care quality and other related issues.

In 2015, Dr. Nicole Alexander-Scott was appointed as the Director of Rhode Island's Department of Health by Governor Gina Rimando. Following the HIT efforts of the previous directors, Dr. Alexander-Scott continues to direct the state's public health planning efforts to use technology to improve the quality and safety of care.

The Department of Health manages several key HIT initiatives to support data-focused public health and the EHR Incentive Program. These include:

- *KIDSNET Childhood Immunization Registry* – This meaningful use registry supports the mandatory reporting of childhood immunizations, and the creation of immunization records and administration schedules to support primary care providers. This registry helps EPs and EHs meet the Public Health meaningful use objective.
- *Syndromic Surveillance Registry* – This meaningful use registry supports the communication of early symptomology of patients presenting at the emergency rooms throughout the state, to assist in early intervention and public health response in the case of public health emergencies. This registry supports EHs in meeting the Public Health meaningful use objective.
- *Electronic Lab Reporting* – This meaningful use registry supports the communication of reportable disease from labs to the Department of Health. The Department of Health uses the National Electronic Disease Surveillance System (NEDSS). This registry supports EHs in meeting the Public Health meaningful use objective.
- *Prescription Drug Monitoring Program (PDMP)* – Pharmacies in the state are required to report the dispensing of Schedule II, III, IV, and V medications within 24 hours to the PDMP. The PDMP provides a web-based provider portal for providers and their delegates to review the controlled substances dispensed to their patients before issuing new or continuing prescriptions.

The RIDOH also has hired a Public Health Meaningful Use and Informatics Coordinator to assist with the planning and coordination of Meaningful Use activities that support the Medicaid EHR Incentive Program, including HIE initiatives. This individual works closely with the state's HIT coordinator, the SIM HIT Specialist and the Medicaid EHR Incentive Program Manager who are all located at EOHHS. The Rhode Island Department of Health (DOH) provides critical oversight and liaison functions that ensure DOH's alignment with other HIT efforts across the state.

A.5.3 Department of Behavioral Healthcare Developmental Disabilities and Hospitals (BHDDH)

The Department of Behavioral Healthcare Developmental Disabilities and Hospitals (BHDDH) has been a strong partner in promoting Health Information technology and the use of Currentcare among the community mental health centers (CMHOs). Most CMHOs have adopted or implemented EHRs. Several years ago, BHDDH partnered with EOHHS and RIQI, the State's Designated Entity for HIE to develop a process and approach to allow 42 CFR part 2 data (confidentiality of alcohol and drug abuse patient record data) become part of CurrentCare. To help achieve, this BHDDH promulgated through regulations a standard Currentcare 42 CFR part 2 consent form to be used by all CMHOs. This consent form is in addition to the standard Currentcare enrollment form. BHDDH has promoted the use of Currentcare to the CMHOs. BHDDH has been critical in advancing the sharing of health information between behavioral health care providers and physical health care providers. RI remains the only state where 42 CFR part 2 data is currently part of a statewide HIE. Additionally, through SIM funding, all community mental health centers will have real time access via a dashboard, updated every 45 minutes, to identify when their patients are admitted to or discharged from any Emergency Department or hospital in RI. This is a separate service from Currentcare and does not rely on individuals BHDDH received and grant from SAMSHA to implement SBIRT screening across the state and as part of that grant, BHDDH proposes to leverage Currentcare and its connectivity to help centralize the capture of SBIRT results and make share the SBIRT screening results among a patients treating provider.

A.5.4 Office of Health Insurance Commissioner (OHIC)

The Office of the Health Insurance Commissioner provides the state oversight on healthcare insurance providers within the state.

OHIC is responsible for:

- Guarding the solvency of health insurers;
- Protecting the interests of consumers;
- Encouraging policies and developments that improve the quality and efficiency of health care service delivery and outcomes; and

- Viewing the health care system as a comprehensive entity and encourage and direct insurers towards policies that advance the welfare of the public through overall efficiency, improved health care quality, and appropriate access.

OHIC is committed to making RI's healthcare system more affordable and easier to use. That's why OHIC has set standards that will support primary care, transform healthcare delivery, and change the way we pay for care. OHIC plays an important role in supporting HIT adoption by regulating commercial health insurers with standards that require advanced practice methodologies only supported by the use of an EHR and the State's Health Information Exchange, CurrentCare. The Health Insurance Commissioner also serves as an ex-officio, non-voting member of the RIQI Board of Directors.

OHIC also supports the Care Transformation Collaborative (CTC, formerly the R.I. Chronic Care Sustainability Initiative, or CSI-RI). Standing at the forefront of Rhode Island primary care practice transformation in RI, CTC is an all-payer program that promotes care for patients through the patient-centered medical home (PCMH) model.

A.6 HIT/E Relationships with Other Key Stakeholder Entities

A.6.1 Rhode Island Quality Institute (RIQI) 's Center for Improvement Science (Formerly Regional Extension Center but often still referred to as the REC)

RI's Regional Extension Center (REC), which was operated by RIQI, is now formerly known as RIQI's Center for Improvement Science. Although RIQI change the name when the ONC's Regional Extension Center funding ended, many in the community still know it as and refer to it as the Regional Extension Center or REC. The REC offers our provider community with Health IT technical assistance, education, guidance, and information on best practices to support and accelerate health care providers' efforts to become meaningful users of Electronic Health Records (EHRs). RIQI's Relationship Managers meet with providers to help them plan their conversion to a certified EHR. Their services go beyond the implementation of new technology by alerting provider practices about incentives or increased reimbursements from payers, i.e. Medicaid or Blue Cross/Blue Shield, as well as promoting, educating and helping providers engage with HIE services. The REC provides one on one technical assistance as well as group education sessions for providers to share their experiences. In addition, they conduct webinars on specific topics such as conducting Security Risk Assessments and protecting patient health information.

The REC recently enhanced their website presence for providers who want to strengthen their HIT efforts. In early 2015, the REC revised their website (<http://www.docehrtalk.org/Home.aspx>) to focus utilizing Health IT tools and functions to support practice transformation efforts. One of the major goals of the REC is to help providers understand the benefits of the State's HIE (CurrentCare), Meaningful Use and how moving

towards EHR adoption will help them succeed. REC services include providing guidance and technical assistance on meeting Meaningful Use, becoming a NCQA's Patient Centered Medical Home, selecting and adopting EHRs, preparing for EHR Incentive audits, assuring privacy and security and conducting a security risk assessment participating in CurrentCare, and using Direct messaging.

Providers who join the REC and obtain their assistance are more likely to meet meaningful use than those providers who do not join. Moreover, the REC's professional network with Health IT vendors, payers, and a majority of health care provider practices proves to be valuable for the providers they serve and the entire healthcare system. Having access to firsthand experience with advances that work well or not work well, prepares a practices with Health IT endeavors they are about to address.

The REC and RIQI are frequent grant awards recipients. In mid-2015, the ONC awarded a two-year, \$2.7 million grant that is supporting the Sharing Health Information for Transitions in Care (SHIFT in Care) project. Leveraging the existing capabilities of RIQI's CurrentCare and REC services will provide the opportunity to expand the capacity for statewide exchange of health information. The grant supports the integration of electronic health records (EHRs) from long-term/post-acute care (LTPAC) facilities, leading to the ability to alert primary care and other providers in the community when patients are admitted to or discharged from long-term care facilities in the state.

In the fall of 2015, the RIQI was awarded two other grants. A one-year, \$100,000 grant to support the Rhode Island Behavioral and Medical Information Exchange project. This initiative will connect behavioral health providers who are ineligible for federal health IT incentives to CurrentCare to expand and improve their ability to electronically send, receive, find and use health information in a manner that is appropriate, standardized, secure, timely, and reliable.

The second grant is a four year \$8.3m Transforming Clinical Practice Initiative award that will provide technical assistance to help equip clinicians in Rhode Island with tools, information, and network support needed to improve quality of care, increase patients' access to information, and spend health care dollars more wisely. As a Practice Transformation Network, RIQI's goal is to support 1,500 clinicians to expand their quality improvement capacity, learn from one another, and achieve common goals of improved care, better health, and reduced cost. The network will provide practice transformation assistance, care coordination tools and services, and performance measurement, reporting and evaluation to help participating clinicians meet the initiative's phases of transformation and associated milestones, clinical and operational results.

In 2015, EOHHS contracted with the REC to try and engage and provide technical assistance to eligible providers in RI who had not yet enrolled to participate in the Medicaid EHR incentive program or who had enrolled but had not continued to participate in the program. The overarching goal was to assist Medicaid providers understand how to reach meaningful use and continue to advance to the next stage and program years. The seven measurable tasks that the REC completed in the contract were:

- Assess 100 Medicaid providers to determine the reason they are not progressing through meaningful use, and provide assistance to reducing those barriers
- Create and deliver educational materials for these providers
- Outreach to all Medicaid providers about the RI Medicaid EHR Incentive program via newsletters and Medicaid provider updates
- Provide education events on topics that were identified as barriers to achieving Meaningful Use (e.g. transitions of care, security risk assessments)
- Assist and educate providers about program audit preparation
- Execute program recruitment efforts
- Provide direct, on-site technical assistance to provider practices

The REC has helped RI's provider community and continues to make a large impact on the HIT goals the State of Rhode Island is pursuing.

The REC is staffed with Relationship Managers who assist practices in redesigning workflow to support implementation of their certified EHR. They share best practices among the practices and help them overcome procedural and technological obstacles. They also educate practices on how to adhere to HIPAA requirements and reduce their risk of a breach. The Relationship Managers are also NCQA Content Expert certified and have prepared many practices to meet Patient-Centered Medical Home (PCMH) certification. Their guidance through the critical process of converting paper-based records to an electronic system have made an impact to EHR Adoption. At the same time, they discover the best ways to incorporate CurrentCare (HIE) tools into each practice's workflow.

One of the real benefits of the REC is their dedication to education and training. This is the core value that the REC provides to practices. They actively work to help providers get the most out of their health IT investment as the HIT market rapidly evolves and develops.

A.6.2 HealthCentric Advisors (HCA)

HealthCentric Advisors (HCA) is a healthcare consulting firm headquartered in Providence, Rhode Island and provides services that synchronize healthcare operations and healthcare technology. HCA, formerly RI's Quality Improvement Organization, now serves as New England's Regional Quality Innovation Network Quality Improvement (QIN-QIO) organization, having been awarded a 5-year contract by the Centers for Medicare & Medicaid Services (CMS). Their teams of clinical, analytic and quality improvement experts provide tools, education and assistance to support providers in Connecticut, Maine, Massachusetts, New Hampshire, Rhode Island and Vermont.

HCA also delivers improved patient care healthcare models and solutions to Assisted Living, Home Health, Hospitals, Nursing Homes, and to Physician and Ambulatory Care practices. Their services include:

- Data Analytics for Quality Improvement reporting

- Practice transformation that directs health care providers towards Meaningful Use, Patient Centered Medical Home, PQRS, and EHR system conversions.
- Safe Transition program improves a practice’s ability to move a patient from one healthcare setting to another. HCA frequently improves practice care transitions by implementing evidence-based interventions developed with feedback from stakeholders from all care settings.

EOHHS and the Department of Health contract with HCA to perform the annual physician Health IT Survey that provides a snapshot of how healthcare technology is used by providers in Rhode Island, which was described in section A.1.2. Additionally, the CEO of HCA serves on the Board of the Rhode Island Quality Institute, staff from HCA assist the State’s HIT Coordinator in convening RI’s hospital CIO's on a quarterly basis to share among themselves and with the state, important information and feedback HIT initiatives, trends and needs across the state.

A.7 Health Information Exchange Organization

A.7.1 Rhode Island Quality Institute (RIQI)- RI’s State Designated Health Information Exchange Organization

The Rhode Island Quality Institute (RIQI) is a not-for-profit organization that was founded in 2001 through a collaboration of leaders in the RI community, with an established mission to significantly improve the quality, safety, and value of healthcare in RI. This collaboration includes consumers, consumer advocacy groups, integrated delivery systems and community hospitals, health insurers, physicians, professional associations, the Medicare Quality Innovation Network Quality Improvement (QIN-QIO) organization, behavioral health professionals, community health centers, skilled nursing and long-term care facilities, employers, academia, and RI state government officials. In 2004 at the request of and in collaboration with RIQI, the RI Department of Health (DOH) applied for and received funding from the Agency for Healthcare Research and Quality (AHRQ) to be one of six states nationally to be awarded a \$5 million, six-year “State and Regional Demonstration Project in Health Information Technology” contract. The goal of this initiative was to develop a statewide health information exchange system that would integrate patient health data from various healthcare organizations, to create longitudinal record and make it accessible to the patients authorized healthcare providers in order to allow providers to provide high quality health care by having the information they need at the point of care as well as to allow them to manage their patient population and reduce gaps in care.

Through a RFP process that was completed in 2007, RIQI was designated as the State’s Health Information Exchange (HIE) Organization, to complete the building of as well as operate Rhode Island’s the Statewide Health Information Exchange (HIE), known as CurrentCare. CurrentCare is a secure electronic system which allows doctors and other care givers immediate access to a patient’s up-to-date health information in order to provide the best possible and most comprehensive care.

Rhode Island Quality Institute is a leader in health information technology committed to improving the quality of healthcare in Rhode Island. As the state's Health Information Organization (HIO), RIQI is responsible for developing, implementing, and operating the statewide HIE. RIQI, which had also been designated by the Governor to serve as the State's Designated Entity (SDE) for the ARRA HIE funds in 2010, works closely with the SMA in developing the HIE Strategic & Operational Plan for the State of Rhode Island. Great strides have been made with the development of CurrentCare. With a concerted effort from the Secretary of Health and Human Services in 2013 and the RIQI Board of Directors, a \$1 Per Member, Per Month (PMPM) voluntary multi HIE funding model initiative was agreed upon and includes public, private and self-insured payers throughout the state. This HIE funding sustainability model has been an approach after which other states are attempting to model their HIE efforts.

RIQI had also been selected as one of the seventeen Beacon Communities and based on the State's HIT participation with CurrentCare, they were able to demonstrate that HIT is a critical tool in improving health care outcomes. The fact that RIQI has successfully obtain numerous major grant initiatives, which are all synergistic provides them with unique opportunities to closely collaborate with Medicaid and its EHR incentive program participants.

RIQI has also been nationally recognized for promoting and integrating the use of Direct Messaging into their infrastructure. RIQI has leveraged direct messaging by relying on that as the standard for transmitting CCDs to and from CurrentCare.

A.7.2 CurrentCare – Rhode Island's Health Information Exchange (operated the RIQI)

Many individuals see several doctors, take multiple medications, and go to several locations for medical tests. CurrentCare ensures that all of an enrolled patient's healthcare providers have the information they need to coordinate the best possible care. Most significantly, CurrentCare contributes to the reduction of medical errors, prevention of avoidable hospitalizations and emergency room visits and improved care coordination between providers.

CurrentCare operates as a centralized HIE. Health care data on enrolled individuals is sent to and stored in CurrentCare by data submitting partners (labs, hospitals, provider offices, radiology, pharmacies via Surescripts etc.), creating a longitudinal health care record for that patient. Providers can access the information with the consent of individual by logging into the Currentcare Viewer (portal) or through their own EHR if bidirectional exchange capabilities have been established.

The use and operation of CurrentCare is governed by the Rhode Island Health Information Exchange Act of 2008. As expressed in the HIE Act, the State of Rhode Island views CurrentCare as the means to promote patient-centered care, allow widespread utilization of electronic

health records by health care providers, improve the quality, safety and value of health care, keep health information secure and confidential, and progress toward meeting public health goals.

Participation in CurrentCare participation is voluntary for both patients and health care providers. Individuals need to consent and actively enroll to have their Health information be shared via CurrentCare. Additionally, health information may only be released from CurrentCare in one of the following three scenarios:

1. In an emergency, to the treating provider(s)
2. With the consent of the patient
3. To a public health authority for those purposes in the interest of the public's health

Furthermore, when a patient enrolls in Currentcare, they are required to identify (consent) to who can access their CurrentCare record. There are three options available: in an emergency only, all treating providers (like HIPPA) or only certain providers (identified by the patient) and in an emergency. As evidenced above the types of potential data users are limited in the law. Last year the HIE Act of 2008 was modified to allow health insurers to access CurrentCare for care management (when patients choose all treating providers which accounts for 98 % of those enrolled) and for quality improvement purposes. The statute was also amended to clearly articulate that patients' can authorize the sharing of their data to caretakers, family members and others of the patients choosing.

Health care Providers who participate in CurrentCare have signed a data sharing agreement with RIQI which includes a HIPAA compliant agreement.

CurrentCare for Me: Consumers now have the ability to access their own data in CurrentCare to view lab results, prescribed medications, condition information, and office-visit summaries, along with the ability to view and download their entire health record in either HTML or CCD formats. This is enabled through a patient portal known as "CurrentCare For Me (CurrentCare4ME)". Individuals can also request to see who has accessed their CurrentCare (though that is not yet part of CC4Me). RIQI is also working on a project entitled "no wrong Door" which would be enabling single sign on to all of a patient's patient portals. It is anticipated that CurrentCare for me will help drive CurrentCare enrollment. As more patients enroll in CurrentCare, more data accumulates and more providers have access to health data to coordinate care, Rhode Islanders will benefit from better, more efficient healthcare.

Funding to continue CurrentCare development and operations is largely based on a multi-payer model. The model is based on payers and self-funded employers contributing a \$1 per member per month (PMPM) based on their number of lives they cover for health insurance. This supports a fair share approach to funding the state's HIE. All of the state's major commercial healthcare insurance providers contribute along with approximately 23 large private self-

funded organizations who provide their employees' health coverage. Naturally, Medicaid pays their share based on the number of Medicaid covered lives and this portion is and has been eligible for a FFP 90/10 share. It is important to note that Medicaid's contribution in this multi-payer model varied based on the amount of dollars that are appropriated for State match. As a result of Medicaid expansion including more individuals than initially expected, the Medicaid PMPM has varied and has ranged from 75 cents to 85 cents per member per month. In addition to the PMPM funding, RIQI has been successful in obtaining grants that continue to build new services off of CurrentCare and its HIE infrastructure. This includes TCIP and SIM dollars along with other ONC grants and some private foundation funding.

CurrentCare has come a long way since it started its HIE endeavor in 2007. As shown in the diagram below, CurrentCare has the ability to exchange many types of health information over a secure network. The goal is to enhance the patient care for the provider and the patient.

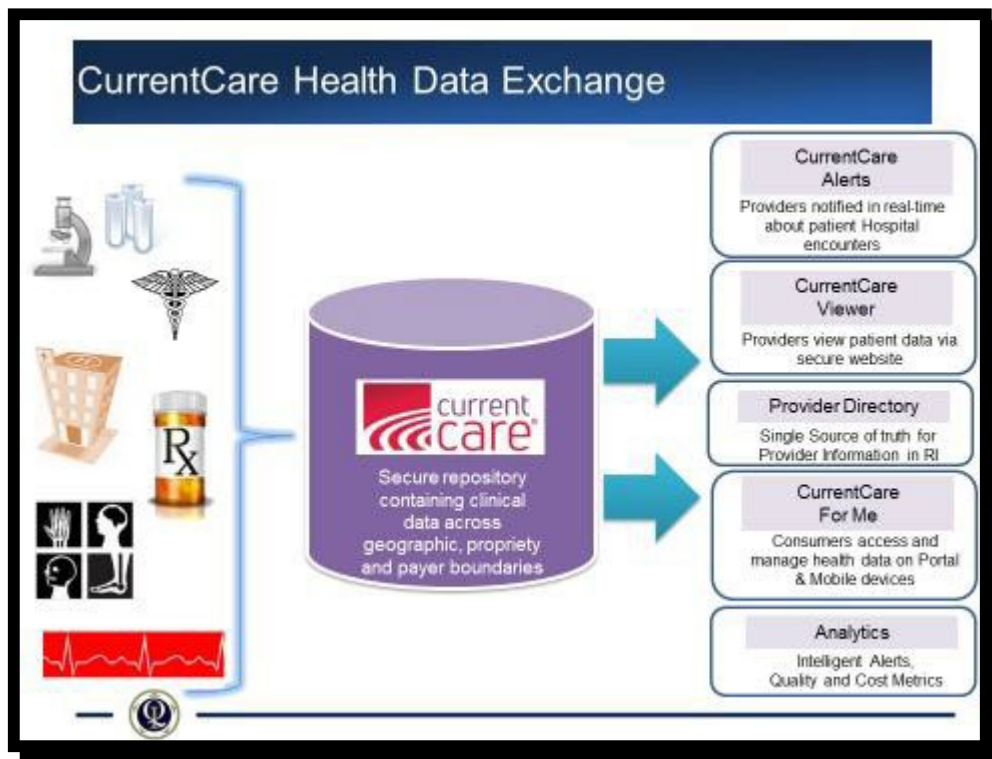

CurrentCare promotes the sharing of a large amount of data received from many providers in the state and more recently from surrounding states. Such accomplishments include but is not limited to obtaining:

- 90% of the Rhode Island prescription data from retail pharmacies in the state. This greatly enhances a provider's ability to reconcile patient medications.
- 90% of the lab results which are coming from both hospital laboratories as and the majority if independent clinical laboratories in the state.
- EKG Imaging and Diagnostic Imaging reports from numerous imaging facilities and hospitals throughout the state and beyond

- 100% of RI's admit discharge and transfer data (ADT feeds). All acute care hospitals send their ADT data in real time.

Hospital Alerts, one of RIQI's HIE services, can notify a provider when their patient has an been admitted, discharged, or transferred to an emergency room and/or hospital. The real benefit for the provider is that they can have immediate information to help provide more coordinated care and reduce re-admission rates by reaching out to the hospital and or patient to discuss the patient's situation, medications and diagnosis. This proactive sharing of care information allows providers to determine if the patient needs to remain in the ED and or be admitted to an acute care facility. This service is available to all providers. Who subscribe for their patients who are enrolled in Currentcare. Additionally, since providers wanted this service to be available for their entire patient panel. RIQI has created the ability provide ED/Hospital Alerts to a provider for their entire patient panel by implementing BAAs with the hospitals and those providers interested in purchasing this service.

Importantly, CurrentCare is also able to Continuity of Care documents from 16 EHRs platforms:

Allscripts	Cerner	GECentricity	Netsmart
Amazing Charts	Epic	Greenway	NextGen
Athenahealth	Essentia	MEDITECH	Intergy
Polaris/Epichart	eClinicalWorks	PointClickCare	MatrixCare

and is receiving Continuity of Care documents from a majority of the acute care hospitals in the state. The CCD allows providers to view problem and medication lists, allergies and sometimes vitals, procedures, and other practice specific information in a longitudinal summary. In addition, several large behavioral health providers have access to information regarding substance abuse when patients have consented to share this information with CurrentCare. A growing number of the EHRs in the state are able to bi-directionally share data with CurrentCare allowing providers to be able to access CurrentCare data from within their own EHR.

The CurrentCare Guidebook is a wonderful resource that RIQI developed to communicate who its data sharing partners are and what they are contributing, as well when new data types and/or data sharing partners are likely be on-boarded next. The link for the guidebook is: <http://www.currentcareri.org/Portals/0/Uploads/Documents/CurrentCare%20Information%20Sources.pdf>

Clinical Data	Encounter Documents			ADTs*	Encounter Data				Tests/Results		
	Clinical Summary	Discharge CoC	Discharge Summary		Allergies	Meds	Diagnoses	Problem List	Labs	Imaging	EKG Imaging
Hospital Systems & Facilities											
LIFESPAN											
Rhode Island Hospital (RIH)	✓	✓		✓	✓	✓	✓	✓	✓	✓	
Hasbro Children's Hospital	✓	✓		✓	✓	✓	✓	✓	✓	✓	
The Miriam Hospital (TMH)	✓	✓		✓	✓	✓	✓	✓	✓	✓	
Newport Hospital (NPH)	✓	✓		✓	✓	✓	✓	✓	✓	✓	
Bradley Hospital											
Lifespan Labs									✓		
Ambulatory Practices - See Pages 10-13	✓				✓	✓	✓	✓			
Gateway Health Center - Part 2 Data	✓				✓	✓	✓	✓			
CARENEW ENGLAND											
Kent Hospital			Coming Soon!	✓	✓		✓	✓	✓		✓
Women & Infants (WHI)	✓		Coming Soon!	✓	✓	✓	✓	✓	✓		✓
Memorial Hospital (MHRI)	✓		Coming Soon!	✓	✓	✓	✓	✓			
Butler Hospital - Part 2 Data	✓				✓	✓	✓	✓			
Ambulatory Practices - See Pages 10-13	✓				✓	✓	✓	✓			
The Providence Center - Part 2 Data	✓				✓	✓	✓	✓			
CHARTERCARE											
Our Lady of Fatima Hospital	Coming Soon!		NEW!	✓	✓	Coming Soon!	✓	✓	✓	NEW!	
Roger Williams Medical Center (RWMC)	Coming Soon!		NEW!	✓	✓	Coming Soon!	✓	✓	✓	NEW!	
Ambulatory Practices - See Pages 10-13	✓				✓	✓	✓	✓			
LANDMARK MEDICAL											
Landmark Medical Center (LMC)				✓	✓		✓	✓	✓		
Rehab Hospital of RI (RHRI)				✓	✓		✓	✓	✓		
LAWRENCE & MEMORIAL											
L & M				✓	✓		✓	✓	Coming Soon!		
L & M Westerly				✓	✓		✓	✓	✓		
SOUTH COUNTY HOSPITAL											
South County Hospital (SCH)	✓		Coming Soon!	✓	✓	✓	✓	✓	✓		
Ambulatory Practices - See Pages 10-13	✓				✓	✓	✓	✓			
VA MEDICAL CENTER											
VA Medical Center	Coming Soon!				Coming Soon!	Coming Soon!	Coming Soon!	Coming Soon!			
Outpatient Clinics	Coming Soon!				Coming Soon!	Coming Soon!	Coming Soon!	Coming Soon!			

*Check for asterisks in the original document for more information. + ADT = Indicator of Inpatient Admission, Discharge and Transfer

Clinical Data	Encounter Documents			ADTs*	Encounter Data				Tests/Results		
	Clinical Summary	Discharge CoC	Discharge Summary		Allergies	Meds	Diagnoses	Problem List	Labs	Imaging	EKG Imaging
Other Data Sources (Independent Facilities)											
URGENT CARE											
Apple Valley Family Treatment Center	✓				✓	✓	✓	✓			
Armistice Urgent Care Center	✓				✓	✓	✓	✓			
CVS Minute Clinics (8 sites)	✓				✓	✓	✓	✓			
Providence Community Health Centers Express	✓				✓	✓	✓	✓			
IMAGING											
Advanced Radiology										✓	
Coastal Imaging										✓	
Open MRI of New England										✓	
Rhode Island Medical Imaging										✓	
XRA Medical Imaging										✓	
LABS											
Coastal Medical (labs)									✓		
Dominion Diagnostics									✓		
East Side Clinical labs									✓		
Quest Diagnostics									✓		
SKILLED NURSING FACILITIES											
Genesis HealthCare (see list below)	Coming Soon!			NEW!	NEW!	Coming Soon!	NEW!	NEW!			
Health Concepts (see list below)	Coming Soon!			Coming Soon!	Coming Soon!	Coming Soon!	Coming Soon!	Coming Soon!			
<small> [Hatched] Hatches indicate that data type is not applicable for the source [Green] Empty cell indicates that data from this source is not currently available *ADT = Notification of ED/Inpatient Admission, Discharge and Transfers </small>											
SKILLED NURSING FACILITIES > Expanded											
Genesis HealthCare Coventry Skilled Nursing & Rehab Grand Islander Center Grandview Center Greenville Center Skilled Nursing & Rehab Greenwood Center Kent Regency Pawtucket Center Skilled Nursing & Rehab South County Nursing & Rehab Center Warren Center Skilled Nursing & Rehab						Health Concepts Bayberry Commons Eastgate Nursing & Rehab Center Elmwood Health Center Heritage Hills Nursing & Rehab Center Morgan Health Center Pine Grove Health Center Riverview Healthcare Community South Kingstown Nursing & Rehab Center Village House Convalescent Home West Shore Health Center Westerly Health Center					
<div style="border: 1px solid orange; padding: 5px; display: inline-block;"> Did you know? You can find 90% of all RI clinical laboratory results in CurrentCare! </div>											

A.7.3 The Role of MMIS in the Current Environment

RI's Medicaid Management Information systems (MMIS) is an integral part of the state's HIT Initiatives. It supports and integrates with MAPIR, given that RI is part of the 13 state collaborative that uses MAPIR as the state's EHR incentive program attestation system. Additionally, the MMIS system generates a quarterly file of all Medicaid enrollees and sends to RIQI so that it can be matched against the CurrentCare enrollee file. This allows the state to track the percent of Medicaid beneficiaries that are enrolled in Currentcare and to try and determine strategies for increasing enrollment in Currentcare among the Medicaid population. Currently about 38% of Medicaid beneficiaries are enrolled in Currentcare. This compares to 46% for the state overall. Lastly, MMIS is used to support the state's All Payer Claims Database (APCD) known as HealthFactsRI by submitting all of the Medicaid claims the APCD.

A.7.4 State Activities to facilitate HIE and EHR Adoption

State activities to facilitate HIE and EHR Adoption are described in Sections A.5 and A.6

A.8. State HIT Coordinator

RI's State HIT Coordinator position is located within EOHHS and facilitates the coordination of Health IT initiatives across the state that supports health care reform through promoting the adoption of Electronic Health Records, participation in the EHR Incentive Program, development, implementation and the utilization of the Health Information Exchange Services (HIE) across the state as well as the development of the state's All Payer Claims Database and other relevant HIT projects. The State HIT Coordinator also serves as the state's point of contact to Federal Agencies focused on HIT and/or HIE initiatives. In addition, the Health IT Coordinator is the EOHHS liaison for the state's Regional Health Information Organization (RHIO) the Rhode Island Quality Institute (RIQI).

The State HIT Coordinator is working to align statewide HIT efforts across and within Rhode Island, and oversees the state's Medicaid EHR Incentive Program and its program manager. The State HIT Coordinator also oversees the state's SIM HIT work plan, and serves on additional multi-agency HIT projects, such as the APCD Interagency Staff Workgroup and the Provider Directory Advisory Commission.

The operational functions of the Rhode Island Medicaid EHR Incentive program have been under the supervision of the State HIT Coordinator at EOHHS Since 2013. At that time, the decision was made to separate the audit function for this program and have the audit function be the responsibility of EOHHS's Office of Program Integrity (see chart below).

A.9. Medicaid Activities That May Impact the EHR Incentive Program

There are numerous efforts underway to continue to align and coordinate various initiatives and efforts within Medicaid and across EOHHS. EOHHS has recently clarified its organizational structure and has created a Data and Analytics Team which is separate from the its Implementation and Policy Team. Although the HIT work cuts across both areas, The State HIT Coordinator position is officially part of the Data and Analytics Team. While the state HIT coordinator works with many initiatives across EOHHS, its agencies and the state, locating the position within this unit helps to foster ongoing efforts to assure that HIT and HIE efforts continue to influence and become a critical aspect of all Medicaid activities and vice versa. As RI Medicaid moves towards implementing Accountable Entities and its health system transformation system program, Medicaid staff have consulted with the EHR incentive program manager, the State's SIM HIT specialist (who also reports to the state HIT Coordinator) and the state HIT Coordinator. Additionally, RI's Medicaid program will be undergoing a MITA 3 self-

assessment and the above HIT staff will participate where appropriate to assure the EHR incentive program is represented and any resulting work is accomplished over time

A.9.1. RI Bridges (UHIP)

RI Bridges (formerly known as Unified Health Infrastructure Project, UHIP) is designed to be a single technical platform that supports eligibility and enrollment for Medicaid, the state's health insurance exchange known as HealthSource RI, and most recently many of the other state's human service programs (SNAP, TANIF, etc.) by collecting consumer information in a through a centralized system. RI Bridges is an interagency initiative between HealthSource RI, the Executive Office of Health and Human Services (EOHHS), and the Office of the Health Insurance Commissioner (OHIC). Although there have been significant unanticipated challenges during the initial deployment of RI Bridges, these challenges have not impacted the operations of the HER Incentive program. Moreover, a significant amount of time and energy is going into improving and fixing the aspects of RI Bridges that were not working correctly.

A.9.2. Re-inventing Medicaid in Rhode Island

In February 2015, Governor Raimondo established the Working Group for Reinventing Medicaid with the duty to review the current Medicaid program and recommend specific quality improvement and cost containment measures for redesigning Medicaid¹¹. The group identified many shortcomings of the current program, including misaligned incentives across the delivery system, fragmented and non-coordinated service delivery, and an inability to address social determinants of health, that ultimately result in high costs and less than favorable outcomes. The Working Group's final report includes ten goals based on four principles: 1) Pay for value, not for volume; 2) Coordinate physical, behavioral, and long-term healthcare; 3) Rebalance the delivery system away from high-cost settings; and 4) Promote efficiency, transparency, and flexibility. The working group recognized the importance of leveraging Health Information Systems and Technology to ensure the delivery of high quality and coordinated care. Goal 7 of the working group specifically addresses this and indicates that specifically states that "One of the most critical pieces to achieving a successful coordinated care health system is the proper use of available health information technology. Rhode Island is leading the way in supporting patients and providers with CurrentCare, a secure electronic network that gives authorized medical professionals access to their enrolled patients' most up to date health information, including lab results, medications, and hospital visits". Given the above, the report sets a target such that **75 percent of Medicaid members will be enrolled in CurrentCare by 2018**. And states that the "broadening adoption of sophisticated electronic health record (EHR) systems will also help provide this kind of connectivity and data-sharing". Additional information is available at: <http://reinventingmedicaid.ri.gov/>

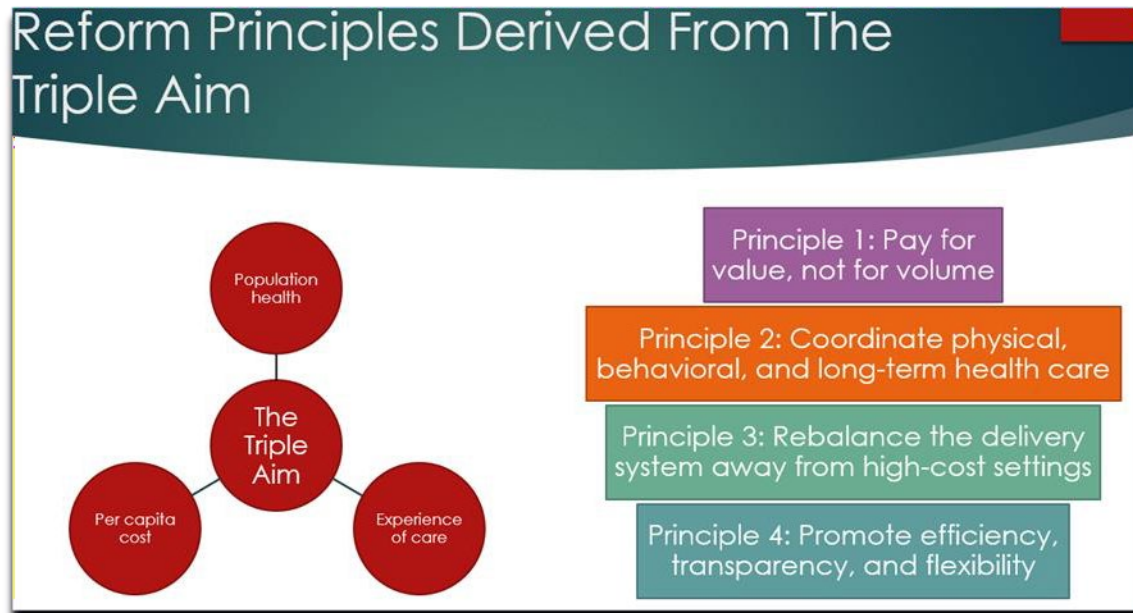

A.10. State Laws and Regulations

In the 2016 state legislative session, a bill was passed to amend the Health Information Exchange Act of 2008. Two changes were made to the law. The first change clarified that individuals enrolled in Currentcare can choose to have their Currentcare record shared with individuals they designated such as caregivers and family members. The second change allowed for health insurers to see their members' CurrentCare data for the purpose of care management or quality improvement activities.

Also in the 2016 state legislative session a bill was passed to amend the prescription drug monitoring program (PDMP) law to allow for data to be shared with technology vendors. Before this change, EHR and/or HIE integration with the PDMP through electronic interfaces was not legally allowed under the statute. With this law now in place, HIE integration activities with the PDMP are ramping up.

Other than the above, there have not been any statutory changes or regulations that impact the implementation of EHRs or the EHR Incentive Program. EOHHS requires no additional authority to administer the EHR Incentive Program other than to obtain budget authority to use and distribute EHR incentive program funding and for a state match appropriation.

A.11. HIT/HIE Activities that Cross State Borders

Rhode Island participates in the 13 state MAPIR collaborative, which has and continues to provide significant cost savings to the state for administrating the EHR Incentive Program. This multi-state effort allows information sharing including best practices among the partner states.

Additionally, Rhode Island's HIE, CurrentCare, has begun to engage in cross border data sharing efforts. As a result of some hospital mergers, RIQI is now collecting data from Connecticut (Lawrence & Memorial hospital and soon to be acquired by Yale New Haven hospital). RIQI is also working with the SouthCoast health system (in southeastern MA) to obtaining ADT feeds as well as other data. Such efforts expand the utility and value of CurrentCare not just for Rhode Island but to the other states as well.

A.12. State Immunization Registries & Public Health Surveillance Databases

The Rhode Island Department of Health (RIDOH) is an active and valuable partner to EOHHS in advancing state HIT goals and in supporting the public health components of the EHR Incentive Program. RIDOH has the electronic capability to support some but not all of the public health meaningful use objectives that providers are asked to attest to. The Department of Health's Public Health Informatics and Meaningful Use Coordinator works with and coordinates across the various public health programs which a related public health meaningful use objective. Additionally, RIDOH is evaluating if other program databases, such as the states birth defects registry could be considered "other registries" under the meaningful use program. The status of each of current public health programs which EPs or EHs need to attest to are described below.

A.12.1 Accepting Electronic Immunization Files

KIDSNET is a secure child health database links and integrates information from 10 different public health program for every child born in Rhode Island as well as those that move to the state. It serves much like an HIE for child public health programs. In addition to serving as the state's childhood immunization registry, it also contains relevant individual level data from vital records, all 3 newborn screening programs (metabolic, hearing and developmental screening), birth defects registry data, home visiting data, early intervention data, and data from the supplemental nutrition programs for women, infants and children (WIC). KIDSNET allows pediatricians, other authorized health care providers, and RIDOH program staff to access information to ensure that all children in Rhode Island are as healthy as possible by getting the right health screenings and preventive care at the right time.

Currently, KIDSNET, which is RI's immunization registry can only accept data on patients 18 or younger. KIDSNET accepts Immunization HL7 2.5.1 messages from provider's EHR systems, and has and continues to onboard EPs and EHs if they vaccinate at least one patient 18 years old or younger in reporting period. All other EPs and EHs can claim an exclusion for the immunization registry component of the public health objective. RIDOH is seeking to expand the immunization registry component of KIDSNET, turning it into a life-long registry as well as create bidirectional interface with CurrentCare.

EOHH works closely with the KIDSNET program staff. Designated KIDSNET staff oversee and manage the immunization onboarding process, and communicates progress with the EHR Incentive Program Manager so that he can verify for the programs pre audit process which EPs and EHs have been able meet applicable Meaningful Use requirements. KIDSNET staff request that registration of intent for the Immunization meaningful use Stage 2 objective is received no later than the 60th day from the start of the eligible provider or hospital's reporting period. The RIDOH staff work with the EP or EH to test that HL7 immunization messages are successfully being sent to KIDSNET and to establish and/or maintain ongoing immunization HL7 messaging.

A.12.2 Electronic Syndromic Surveillance Files

The RI DOH has the capacity to accept Syndromic Surveillance data from emergency room hospital admissions in HL7 format as they occur. Hospitals who want to participate register their intent with the RIDOH and work with the RIDOH staff through the onboarding process to test and send ongoing HL7 syndromic surveillance messages.

A.12.3 Electronic Lab Results and Reportable Diseases

RI DOH's Division of Infectious Disease and Epidemiology currently accepts electronic laboratory results data related to reportable diseases from eligible hospitals and clinical laboratories in HL7 format. Similar to syndromic surveillance, registration and test messaging or ongoing submission of reportable diseases is required.

A.12.4 Cancer Registry

RIDOH's cancer registry is maintained by the Hospital Association of Rhode Island (HARI). There is no electronic reporting capability at this time, although there have been some initial discussions about how to collect the depth and complexity of data that HARI currently collects on paper. One of the major barriers which is diminishing over time is that the EHR adoption rate among oncologists is perceived to be lower than other specialists.

A.13. State HIT-Related Grants

A.13.1. SIM Test Grant

In 2015, Rhode Island was one of 24 states to receive a State Innovation Model (SIM) Test Grant from the federal Centers for Medicare and Medicaid Services (CMS). The state received \$20 million with the expectation that the funds would be used to transform the way healthcare is delivered and paid for – and to improve Rhode Island’s population health. SIM’s funds are investing in three categories of activities: improving the primary care and behavioral health infrastructure, engaging patients in positive health behaviors and self-advocacy, and expanding the ability of providers and policy makers to use and share data. Rhode Island’s SIM believes that by transitioning to a system of value-based care that addresses social and environmental determinants of health, SIM can support Rhode Island in enhancing the physical and behavioral health of the population, improving the experience of care, and spending our healthcare dollars in a smarter way.

Rhode Island SIM is led by a team of staff from several state departments, including the Executive Office of Health and Human Services, and its member agencies and programs (Medicaid, and the Departments of Health (DOH), Human Services (DHS), Children Youth and Families(DCYF), and Behavioral Healthcare, Developmental Disabilities, and Hospitals (BHDDH). SIM participants also include the Office of the Health Insurance Commissioner (OHIC), and HealthSource RI (HSTI). SIM is officially governed by a Public- Private Steering Committee made up of a diverse range of stakeholders, including providers, insurance carriers, patient advocates, and community organizations. We encourage stakeholders and interested individuals to participate in the various working groups that SIM convenes on specific topics related to healthcare transformation.

The vision of the Rhode Island SIM Test Grant represents the desired future state resulting from a transition to value-based care in the state. Our vision statement, borrowed from the Triple Aim, reads: Continuously improving Rhode Islanders’ experience of care (including quality and satisfaction), enhancing the physical and behavioral health of all Rhode Island’s population, and smarter healthcare spending. There is a strong focus on HIT investments as part of the SIM grant, including several of the projects discussed in other sections of this plan (statewide common provider directory, care management dashboards, HealthFacts RI eQCM Reporting and measurement system, EOHHS EcoSystem). SIM has also provided funding for EOHHS to hire an HIT Specialist who works as part of the SIM staff team but is supervised by the State HIT Coordinator and is located within EOHHS. The HIT Specialist assists the State HIT Coordinator with the management of HIT contracts under SIM and strategic planning for HIT within Rhode Island.

A.13.2. Department of Health Grants

The RIDOH receives numerous grants to help support public health information systems, especially for Electronic Lab Reporting (ELR), Syndromic Surveillance, and the Prescription Drug Monitoring Program (PDMP). EOHHS coordinates with RIDOH through the Meaningful Use/Public Health Informatics Coordinator to align HIT strategies across EOHHS agencies.

A.13.3. SBIRT Grant

The Department of Behavioral Healthcare, Developmental Disabilities and Hospitals (BHDDH) received an \$8,291,875, 5 year grant from the Substance Abuse and Mental Health Services Administration (SAMHSA) which began in October 2016. This grant will promote the use of Screening, Brief Intervention, Referral and Treatment (SBIRT) throughout Rhode Island, with a goal of conducting 250,000 screenings over the five-year period.

A key component of this grant included investing a portion of the funding in Health Information Technology that allows for screenings to be conducted electronically and shared among treating providers. BHDDH is collaborating with SIM to contract with a consolidated operations vendor for both SBIRT and SIM Community Health Team (CHT) activities. The contracted vendor will conduct an HIT assessment of the capabilities of SBIRT screening sites (PCP practices, EDs, CHTs etc.). This will help inform how to appropriately and effectively capture and share SBIRT screening results. The current plan is to build a screening tool module as part of the HIE, but this strategy is subject to change if the implementation sites do not have a need for the module (already capture this data in their EHR etc.).

B. To-Be Assessment – The Future HIT/HIE Landscape

B.1. Five Year Vision Overview

Over the next five years, we are looking to achieve five main goals:

1. Continue a positive trend toward adoption of Electronic Health Records, with 90% of hospitals, primary care providers, and outpatient specialists adopting CEHRT by 2021.
2. Achieve a 75% meaningful use conversion rate among RI Medicaid Eligible Providers (from AIU to MU) by 2021.
3. Continue to increase the number of Rhode Islanders participating in Currentcare, with:
 - A. 90% of Rhode Islanders having a Currentcare record by 2021
 - B. 80% of all Medicaid beneficiaries with a Currentcare record by 2021.
4. Continue to increase the value of the Health Information Exchange by increasing awareness and use of the CurrentCare, with 75% of physicians knowing of and using CurrentCare by 2021.
5. Continue to expand Health Information Exchange services and increase the interoperability among the state's HIT services (includes HIE services and EHRs and other HIT systems such as APCD) where appropriate, with a goal of increasing efficiency and utility while decreasing duplication.

B.2. HIT Future Initiatives (includes several beginning to be implemented)

EOHHS is continuing to invest in state HIT systems that help support practice transformation, inform policy, and support operational needs for the state and the community. The goal is to support the data and analytics needs of both state agencies and the healthcare community. Additional detail of the enhancements to be made follows.

B.2.1 Electronic Clinical Quality Measurement Reporting and Feedback System

Clinical Quality Measurement (CQM) reporting and feedback is a critical component in quality improvement efforts, in transforming the health care system and has and continues to be an important part of the Medicaid EHR incentive program. Providers often have to report similar yet different quality measures to measure the same outcome, and they need to report them to numerous different entities. Providers, ACOs and facilities in Rhode Island have noted the number and variety of reporting requirements is likely to continue to increase under a value based payment system.

Numerous sources support the assumption that analytic resources and capabilities are insufficient in the state to empower providers and organizations to most effectively use their ever-growing and extremely valuable data. Furthermore, numerous organizations in the state are working toward creating their own quality measurement systems that will meet their needs, including payers, practices, and practice transformation organizations.

Given the above environment and given that the initial SIM HIT plan had anticipated the need for a statewide eCQM reporting and feedback system, the SIM Steering Committee convened a SIM Technology Reporting Workgroup to verify whether a statewide Clinical Quality Measurement reporting and feedback system was needed and would be desired in RI.

The SIM Technology Reporting Workgroup was comprised of payers, quality improvement organizations, the state's designated HIO, data and analytic staff from large provider practices, and a few practicing providers and state staff. After several meetings the SIM Technology Workgroup recommended funding the development of a statewide electronic quality reporting system with the goals of:

- Improving the quality of care for patients and driving improvement in provider practices by giving feedback to providers, provider organizations and hospitals about their performance based on quality measures
- Producing more valuable and accurate quality measurements based on complete data from the entire care continuum
- Leveraging centralized analytic expertise to provide valuable and actionable reports for providers and to drive improvements in population health
- Reducing the duplicate reporting burden upon providers and provider organizations by having a common platform for reporting
- Publically reporting quality measurements in order to provide transparency and support patient engagement in making informed healthcare decisions
- Using existing databases, resources and/or systems that meet the various stakeholders needs, rather than building from scratch

The workgroup has determined that in order to achieve these goals, the system would need serve as a common platform for quality measurement, quality improvement, and reporting. It would need to be able to accomplish the following, at a minimum:

- Easily capture data (electronically) in a standard and consistent manner (no extra work for providers)
- Calculate measures based upon the SIM harmonized measure set and relevant national measure sets, including those used in the meaningful use program

- Become a Qualified Clinical Data Registry (QCDR) to allow the reporting of results directly to CMS, NCQA, and the payers, and fulfill additional reporting obligations on behalf of providers
- Benchmark providers at the provider level and the provider organization level
- Consist of detailed, individual level data from multiple sources matched to a single person, and make that data available to providers to improve individualized care while appropriately protecting confidentiality
- Share analyses and results back to providers, provider organizations, payers, state government, and, eventually, the public

This project will begin to focus on collecting data from practices with Electronic Health Records (EHRs). In addition, the state must set up a governance structure with adequate community and provider engagement to determine what data is shared to whom and how it is shared. EOHHS just has issued an RFP for the development and ongoing operations of this system. EOHHS envisions the system will be developed and operated by a third party data intermediary, especially given the system is anticipated to serve all providers for a number of different programs over time. As this work gets underway, there will be an analysis of how to streamline work and interface this system with MAPIR such that over time providers do not need to enter their MU CQMs into MAPIR.

B.2.2. HealthFacts RI Conversion

The first phase of HealthFacts RI, Rhode Island's All Payer Claims Database went live in February 2016. This tool contains the most comprehensive collection of health care claims data that the state has ever had. It will illuminate how Rhode Islanders use the healthcare system, the effectiveness of policy interventions, and the health of our communities.

The most powerful feature of HealthFacts RI is that it collects, organizes, and analyzes health care data from nearly all major insurers who cover at least 3,000 individuals in Rhode Island. The existing RI APCD is currently a stand-alone database, hosted and stored externally by an outside vendor and managed by multiple state agencies.

Given the analytic value the APCD has to Medicaid, specifically including EOHHS/Medicaid to integrate data-driven, evidence-based programmatic decisions into its daily Medicaid operations, and to ensure sustainability for effective reform initiatives beyond SIM funding. EOHHS has proposed to leverage these existing APCD processes and infrastructure by converting the RI APCD into a Medicaid IT Enterprise module, through the following activities:

- Enhancing the database with data elements for Medicaid Program monitoring, reporting and evaluation purposes;
- Converting the existing database into a Medicaid IT Enterprise module and moving it into a state-operated, Medicaid IT Enterprise environment;
- Transitioning management and control of the database solely to the Medicaid Program, with operational support from other agencies; and
- Building new analytic capabilities that are not yet developed, using Medicaid Enterprise tools.

The HealthFacts RI module will enable analytic functionalities necessary for RI Medicaid to meet federal reporting requirements, measure provider performance to evaluate payment reform initiatives, operate the Program more efficiently, and achieve Medicaid's health system transformation goals. Specifically, the database will provide:

- Comprehensive views of former and current Medicaid beneficiaries through longitudinal, cross-payer utilization, provider, and payment data;
- Payment and utilization comparisons for provider benchmarking and rate restructuring purposes;
- Data to evaluate and inform healthcare reform efforts for Medicaid in relation to SIM initiatives;
- Comparative cross-payer utilization and payment data to evaluate Section 1115 Medicaid Research and Demonstration waivers, in accordance with federal requirements; and
- Access to an integrated, longitudinal utilization and payment dataset for Medicaid-Medicare dual-eligibles.

Additionally, the database will streamline Medicaid analytic capabilities by:

- Re-using the Medicaid Enterprise-wide, state-licensed analytic platform;
- Building nimble, broad and deep Medicaid analytic capability that is currently unavailable to Medicaid program managers and decision makers; and
- Leveraging cost effective, interoperable data architecture that promotes future integrations and avoids vendor lock-in by installing the database in a state-hosted Enterprise environment and maximizing Medicaid state and federal investments to date.

With access to claims, enrollment and provider data from multiple payers, as well as value-added enhancements that will be applied for Medicaid purposes, the HealthFacts RI module will allow for necessary reporting and analytics, such as comparative analysis and benchmarking that would otherwise not be possible.

B.2.3. Statewide Common Provider Directory

The ability to obtain and keep up to date information on health care providers including practice and payer affiliations is very challenging. Numerous health care organizations in the state create and maintain their own provider directory to the best of their ability but there is often no consistent method for keeping the data updated, resulting in different data in different organizational provider directories. Furthermore, many provider directories do not track affiliations and organizational hierarchies which are needed for analytics such as when providers were under operating under different payment models.

As part of the State's SIM HIT plan, the state proposed to develop a single statewide common provider directory. Since RI's state designated entity for HIE, RIQI was already well underway in building a provider directory with affiliations and organizational relationships for CurrentCare, EOHHS decided to contract with RIQI to leverage the work done to date, and have them serve as the vendor to build maintain and operate the Statewide Common Provider Directory. This directory will consist of detailed provider demographics as well as identifying both relationships between providers and organizations and organizational hierarchies. This organization hierarchy being built into the provider directory is unique and is an essential aspect to being able to maintain not only provider demographic and contact information, but their relationships to practices, hospitals, ACOs, and health plans. The intent of this project is to:

- Allow for the mastering and maintenance of provider information and organizational relationships to only occur once in the state in a central location;
- Use the web-based tool that was developed to allow a team of RIQI staff to manage and maintain provider import files and data survivorship rules, error check flagged inconsistencies or mapping questions, and manually update provider data or enter new providers;
- Develop and institutionalize the appropriate data mastering and maintenance system to allow for useful data export via a flat file.
- Provide iterative data exports that allow for hospitals, payers, and state agencies to incorporate the centrally-mastered provider data within their own databases; and
- Increase ability for consumers and providers to have up to date and accurate information about providers by having a consumer portal and a provider portal.

As part of EOHHS contract, RIQI will increase the number of provider files imported and provided a number of data exports. Discussion are underway to assess the ability to import Medicaid provider's files as well as to determine how Medicaid can use the data from the statewide common provider directory and Medicaid's ability to receive and use a mastered file.

Other deliverables include operational support to continuously master and verify the data, provide required infrastructure support, and develop a public facing website. The public facing websites are still under development and the anticipated go-live mid-2017.

Over the next five years, the provider directory will need to be continually developed to serve a growing number of needs, including but not limited to support accurate referrals, serving as a single update point for providers that then disseminates updates to interested parties, supporting analytics activities, and helping consumers choose insurance plans.

B.2.4. Integrated Health and Human Services Data

Ecosystem

Rhode Island lacks a modern system for integrating person-level information across our EOHHS agencies (Medicaid, the Department of Behavioral Health, Developmental Disabilities and Hospitals (BHDDH), the Department of Children, Youth and Families (DCYF), the Department of Human Services (DHS), and the Department of Health (RIDOH)), and then turning that holistic information into action. These agencies share a mission of providing essential services, safety net support, and public health promotion, while often serving the same people and collecting large amounts of data on these beneficiaries. If we are able to combine and better analyze these data, we can obtain critical information about the needs of our population, the effectiveness of our programs, and how to responsibly spend valuable public resources.

With funding from SIM, Rhode Island will take informed, project-based steps that reflect iterative learning and sophistication to build our new data ecosystem using the agile processes and methodology in order to integrating data across our agencies and driving policy with those data. Rhode Island is planning a light, simple and adaptive solution.

Our approach will build on an ongoing assessment of our entire data ecosystem, which includes our current Medicaid data warehouse and our processes for collecting, managing, and using data, as well as lessons learned from other states. Funding from SIM may be able to support some of the initial work for this project, though it is anticipated that the ecosystem will become another modular component of RI's Medicaid enterprise system and will support answering policy and evaluative questions needed to improve the work of the Medicaid program. EOHHS is beginning to identify what if any existing infrastructure can be leveraged for this purpose, and how this system would relate HealthFacts RI and Currentcare given differing and fairly stringent statutory requirements around sharing of PHI. EOHHS anticipates issuing an RFP to select a vendor to create the ecosystem data warehouse by collecting only the required data elements to answer a specific policy question. Using the agile methodology will allow each policy question to serve as the basis for an agile sprint. EOHHS will also

work with the vendor to develop a complete modernization staffing and structure plan to guide the state during the transition to full ownership of the solution.

B.2.5. Care Management Dashboards

Transforming the health care system requires providers to know when their patients have been admitted to or discharged from the ED or Hospital. The ability to promptly share this information is expected to facilitate targeted, appropriate clinical interventions, improve care coordination and reduce re-admissions. Given this, and the work that RIQI already had engaged in not only to send a hospital alerts via direct messaging to a provider, but also to create a real time dashboard showing a providers which of their patients were in a RI ED or acute care hospital in real time, EOHHS has decided to sue SIM dollars to funding RIQI to implement this real-time communication system at all of between Rhode Island's Community Mental Health Organizations (CMHOs), as well as for the Medicaid's community health team which is coordinating care for Medicaid FFS beneficiaries. RI's CMHOS are mutually responsible for the care of approximately 8500 publicly insured individuals with serious mental illness This prompt information sharing is expected to facilitate targeted, appropriate clinical interventions, improve care coordination and reduce re-admissions. Ongoing funding for operation of the dashboard will come through a PMPM cost to the CMHCs.

B.2.6. Ongoing HIE Development

RIQI, serving as the State's designated HIE Entity is continuing to develop additional technology tools to assist healthcare providers increase their efficiencies in providing care to patients throughout their care continuum. Some of these tools are separate from CurrentCare and can be implemented for an entire provider's patient panel not just those enrolled in CurrentCare) using BAA agreements. In doing so RIQI seeks to leveraging the existing technical infrastructure used for CurrentCare but firewalls off the data where needed. Additionally, RIQI is continuously working to increase in HIE enrollment, adoption and use as noted below.

The work to integrate various data types from RI's adult behavioral health hospital into the CurrentCare environment continues with an emphasis on enabling Observation Result (ORU) or Lab related data. This effort, funded by an ONC Interoperability Grant, will also integrate Admission Discharge and Transfer (ADT) and Continuity of Care Documents (CCDs) from the behavioral health hospital. The initial phase of this project includes a technical effort to incorporate these data-types into CurrentCare for enrolled individuals. The subsequent phase of this project will be to engage Community Mental Health Organizations (CMHO's) to adopt the use CurrentCare (such as CurrentCare Viewer and Alerts), especially given that they often have a hard time getting this data from the behavioral health hospital in a timely manner.

RIQI is also focusing on working with long term and post-acute care facilities (LTPAC). While there was a previous effort to engage with LTPACs (around 2010 funded by special Medicaid Transformation grant dollars) the majority of LTPACs did not have EHRs and the effort to engage them with CurrentCare was not able to be sustained after grant

funding ended. Considering that most LTPACs have an HER, and that there are primarily two EHR vendors supporting RI's LTPACs, technical discussions with Matrix Care and Point-Click-Care are underway to integrate ADT data along with CCDs into the CurrentCare environment. This effort is funded by a separate ONC grant. Integration of these data types from these organizations is an integral part of Transition of Care (TOC).

Although, RIDOH serves as the regulator for the RI's Regional Health Information Organization (RHIO), EOHHS is the state agency which now designates the State's RHIO and oversees the RHIO designation contract. The designation contract outlines annual deliverables to encourage continued development and these deliverables align with those that need to be met for HIE enhanced match funding. These deliverables are organized in 5 categories and evolve each year to include new focus areas and identified high priority needs. The 5 categories are:

1. Increase Enrollment in CurrentCare
2. Increase Data Availability in CurrentCare
3. Improve Data Access and Utilization
4. Engage Consumers by Leveraging the CurrentCare Infrastructure
5. Leverage CurrentCare for Population and Public Health
6. Maintain CurrentCare

Setting deliverables for RIQI each year will continue. As some deliverables are completed, state leadership determines new goals to be added under the above categories. This process ensures that the state is constantly encouraging innovation and further development for CurrentCare and able to monitor the progress over time.

B.2.7. Expanded HIE Activities

EOHHS is requesting enhanced Federal Financial Participation for several projects to further enhance HIE services in Rhode Island under the expanded opportunities in SMD #16-003. This includes the following projects which are also detailed in RI's IAPD-U that was submitted in December and is pending approval:

- **Advanced Emergency Department Alerting** - Embed HIE data into the EHRs of all hospital EDs in Rhode Island so that the data can be easily accessible to ED providers and to have the HIE data pre-analyzed so that it can alert to ED providers to patients at risk of certain conditions like substance use disorders. All hospitals in RI are already sending ADT data on all patients (not just those enrolled in CurrentCare) to the Rhode Island Quality Institute, the state's designated Health Information Organization (HIO). These data are shared under HIPAA Business Associate Agreement with RIQI, and go beyond the consent-based HIE to include all

patients with treating relationships to the hospitals. The embedded data will consist of an alert flag in the ED tracker board which will highlight PDMP information, treating relationships with PCP or community mental health organizations, ED utilization history, relevant clinical history, and risk modeling based upon the design requested by clinicians in the ED.

- **Connecting the Statewide EMS Reporting System to the HIE -**
Establish a bi-directional connection between the statewide EMS reporting system operated by the Department of Health and CurrentCare in order to assist with the transition of care from the EMT to the hospital as well as inform the PCP and other providers. Implementing this functionality will require funding to support RIDOH in paying their EMS software vendor to establish a bi-directional connectivity which would allow EMTs to access information from CurrentCare on patients they are responding to, as well as have run report data electronically included in CurrentCare and therefore be accessible to the patient's medical providers through a variety of methods (alert, CCD sent to a providers EHR, CurrentCare viewer).
- **Connecting the Medicaid Community Health Team to the HIE -**
Establish a data feed from CareLink's Eccovia Solutions ClientTrack system to CurrentCare which sends care management records automatically to the HIE once documentation is complete
- **Develop, Implement and promote the use of an Electronic (e)Referral System -** Design, develop and implement an electronic referral system to facilitate referrals between EPs and EHs and other Medicaid providers which is connected to or leverages the provider directory's underlying data and infrastructure.
- **Expand RI's Current Childhood Immunization Registry to Include Adults –** Although the Rhode Island Department of Health (RIDOH) has had a childhood immunization registry since 1997, as of 2015, Rhode Island was one of only three states that does not include adults in its immunization registry. Currently EPs and EHs that do not administer vaccines to children or adolescents take an exemption for the immunization reporting MU objective.
- **Connect KIDSNET Immunization Registry to the HIE -** KIDSNET, RIDOH's integrated child health information system, which includes the childhood immunization registry; vital record birth data; newborn developmental, heel stick, and hearing screening information; WIC program data; and early intervention data does not interface or connect to CurrentCare. Creating some bi-directional exchange capabilities between KIDSNET, including the adult immunization registry, and the HIE would be facilitate the electronic data sharing to and from the immunization registry (providers could send the data to the HIE which could then share it with the statewide immunization registry or vice versa). Additionally, all of the other important health and social determinants data contained in KIDSNET could be integrated into CurrentCare for enrolled children,

making this data available to providers' EHRs through a bi-directional exchange with CurrentCare or helping to reduce provider portal overload and have the data be viewable through CurrentCare viewer instead of having to go to the standalone KIDSNET portal.

- **Develop a Registry Module for the HIE** - Build a registry module on the HIE which allows for extensible care coordination add-ons to the HIE data for public health and health information exchange purposes. This registry module will operate as a data sharing tool for HIPAA covered entities under a BAA with the RIQI as the RHIO, and thus will support data sharing for all patients, regardless of their participation status in the HIE.

The information that would be part of these registries are data types that EHRs struggle with capturing because they are not well structured or may be relevant only in Rhode Island. The data is essential to the effective treatment and care coordination of patients. Each data type mentioned above, is at its most basic level, an advanced form which requires a provider or patient to input information and in some cases may compute results for the user. Because of these commonalities, RI is proposing to build a registry module rather than individual registries for each use case. This registry module would be able to efficiently support all three proposed uses as well as future additional uses and could serve as a specialized registry for Meaningful Use.

The registry module will consist of an advanced form builder which would be used by the technical support staff to create forms for the users. The results of these forms can then be shared via Direct secure messaging or through the HIE if the patient is a participant. Three use cases are identified to support this initial build: SBIRT registry module to support the SBIRT grant discussed previously, eMOLST registry to support the RIDOH Medical Order for Life Sustaining Treatment form, and Shared Care Plan registry to support the work for community health teams.

B.2.8. Enhancements to CurrentCare for Me

Patient engagement is an important component of a transformed health care system and patient portals and other HIT tools can help support patients in actively monitoring their own health. Recognizing that patients may easily have numerous patient portals attached to different EHRs, and that patients may be interested in seeing what is in their Currentcare record, RIQI has worked with their software vendor to develop CurrentCare for Me (CC4ME). CC4ME allows enrolled individuals to access their Currentcare record and in the future to be able to add patient generated data such as family history, advanced directives etc. More specifically, RIQI is working to enable CC4ME to include:

- The ability to upload consumer generated data such as health assessments
- Digital health device data
- Advance Directives/MOLST documents
- Medical history.

- Test messages about Admission, Discharge or Transfer alerts for caregiver proxies.

RIQI is also considering including patient-centered shared decision making, advanced illness care planning and behavior change support tools. Tools being considered would be evidence-based incorporating readiness to change, social determinants of health and health confidence.

Lastly, RIQI is in the early conceptual design phase of a “No Wrong Door” approach to patient portals. This concept would allow patients to seamlessly navigate their multitude of patient portals without having to sign in to each portal separately.

B.2.9. Assisting Providers with Meeting Meaningful Use

Given that 2016 was the last year to register for the Medicaid EHR incentive program, there is no longer need to focus on bringing new providers to the EHR Incentive Program. Also, EOHHS has decided to end its contract with RIQI to provide technical assistance and outreach to Medicaid providers related to the Medicaid EHR incentive program. RIQI continuously offered its services and many Medicaid providers have already taken advantage of these services. With that said, the interest in these services was waning and it did not seem prudent to continue the contract. Providers needing assistance can still work with RIQI or other practice transformation organizations in the state on a fee for service basis. Additionally, other statewide HIT projects, such as the Electronic Clinical Quality Measurement Reporting and Feedback System and the Provider Directory, will support providers in meeting some of their Meaningful Use goals. The Medicaid EHR incentive program will continue to use the HIT Survey to achieve a greater understanding of the barriers to meeting Meaningful Use and strategize methods of assisting providers, especially where it may involve enhancements to our HIT infrastructure.

B.2.10. PDMP HIE/EHR Integration

With legislative changes in the 2016 legislative session, it is now legally allowable for Prescription Drug Monitoring Program (PDMP) data to be shared with providers and their EHR vendors. This has opened the door for integrations between the PDMP and CurrentCare, as well as between the PDMP and providers’ EHRs. SAMHSA and CDC have both awarded grants to the RIDOH to facilitate some of this connectivity.

In collaboration with EOHHS, RIDOH will be working with RIQI to use the CurrentCare infrastructure to connect the PDMP to EHRs for all the providers’ patients, not just those enrolled in CurrentCare. This will dramatically reduce the expense to providers to connect to the PDMP and facilitate an efficient way to leverage existing technology. The

first connections are expected to be completed by September 2017, with a goal for continual grant-funded integrations through the end of 2018.

B.2.11. Future Development of MAPIR

Rhode Island will continue to participate in the 13 State MAPIR collaborative to support EP and EH attestations for the EHR Incentive Program. Since 2011, Rhode Island has participated in MAPIR and based on the recently CMS approved MAPIR IAPD, RI has been approved 90/10 funding until September 2018.

Our goal is to continue to participate in the MAPIR Collaborative until the program sunsets in 2021. Based on the value-added results we have experienced in the past six years; we are confident that the MAPIR collaborative will continue with CMS's support. We appreciate the support our MAPIR collaborative and MAPIR development team provides by ensuring release changes comply with statute and regulations approved by CMS. Typically, the MAPIR team has developed and deployed system modifications within a three to six-month timeframe. This includes system quality assurance testing both on the core and individual state levels.

Upgrades to MAPIR will follow the MAPIR collaborative schedule, allowing time for customizations if needed. Importantly, as the Electronic Clinical Quality Measurement Reporting and Feedback System is being considered and discussed amongst the collaborative.

B.2.12. Future HIE Governance Structures

The governance of Rhode Island's HIE is not anticipated to change significantly and continues to exist at several levels. RIQI is the state's designated RHIO has a board of directors comprised of a diverse set of health care leaders in the state including representatives from hospitals, systems, payers, private providers, employers, business community, consumer groups, long term and home health care and government (as ex officio non-voting members). There are also some board level committees which then present full recommendations to the board for approval (operating, legal, nominating, sustainability). RIQI also has a number of community based advisory committees that make recommendations about Currentcare and other RIQI HIE services to RIQI leadership. These committees include consumer advisory, Currentcare advisory, Currentcare user group, provider directory advisory, and employer advisory.

RIQI also works closely with state officials. There are weekly calls with the state HIT coordinator and SIM HIT specialist to monitor projects, align initiatives and troubleshoot any areas needed. Meeting are also being set up between the public health informatics

coordinator and RIQI staff to monitor specific projects under way the RIDOH. On a quarterly basis RIQI leadership meets with cabinet level state officials including the Secretary and Deputy Secretary from EOHHS, the Health Insurance Commissioner, the Director of Health and the state Medicaid director. These meetings are to assure that the state's priorities and RIQI's priorities and strategies align at all levels. Lastly, the SIM steering committee which is the governing body for SIM project introduces another form of governance over those projects which are from the SIM HIT plan. The SIM HIT plan clearly aligns with the other statewide HIT efforts being supported and driven by EOHHS. Although the HIE governance may sound cumbersome it is important to remember that RI is a small state and many of the same individuals serve on these various committees, and that the State HIT coordinator, the SIM HIT specialist, the RIDOH public health informatics coordinator and the Medicaid EHR Incentive Program Manager all work closely with each other, with RIQI, and with other community partners to keep the HIT projects aligned, synergistic and avoid any duplication.

B.2.13. Next 12 Months: Improving CEHRT Adoption

There is considerable pressure on payers to support practice transformation, value-based payment arrangements, and patient centered medical homes. This pressure continues to trickle down to the providers who are seeking CEHRT to remain relevant with providers. It is also likely that MACRA and MIPS payment adjustments will serve as a major motivator.

Although EOHHS will not be funding any specific practice transformation efforts to encourage CERHT adoption, there are numerous activities occurring in the state, including several of the RIQI grants described earlier, SIM initiatives, activities undertaken by HIC on care transformation and activities undertake by HealthCentric Advisors as the QIN-QIO. RIQI and HCA serve as experts in the state to help support how adoption of CEHRT supports practice transformation efforts and to provide extra assistance to providers who may not know where to start.

B.2.14. Leveraging FQHC HRSA HIT/EHR Funding

All FQHCs in the state have adopted Certified EHR Technology. If HRSA HIT/EHR funding opportunities occur over the next five years which encourage collaborating with state agencies or the HIE, EOHHS will support the FQHCs in applying for the opportunities and achieving their goals where possible.

B.2.15. Assessing and Providing Technical Assistance to Medicaid Providers - see B.2.9

B.2.16. Populations with Unique Needs

As part of the states SIM test grant, an initial population health plan has been developed. This plan is a work in progress and is seeking to integrated information related to social determinants of health into numerous projects including some HIT initiatives (Currentcare for Me, provider directory, ED alerting etc.). Additionally, there has and continues to be a strong focus on integrate the delivery of physician and behavioral health and this includes needing to having this information integrated in EHRs and The state's HIE. RI was the first and perhaps still the only state to have been able to integrate behavioral health and substance use data into CurrentCare to assure appropriate care is delivered to this population. As HIT efforts continue to address the needs of various unique populations, this section of the plan will be updated further.

B.2.17. Leveraging HIT-Related Grant Awards

Wherever possible, Rhode Island has leveraged HIT-related grant awards from federal agencies, and also sought IAPD funding for applicable items. Program staff at EOHHS, OHIC, RIDOH, and BHDDH are constantly on the lookout for additional funding opportunities which may support meeting state goals.

RIQI has also been extremely successful at receiving federal and private foundation grant awards that have supported continual HIE development, practice transformation activities that support adoption to CEHRT, and innovation opportunities that expand the breadth of our HIE work.

In the coming year, EOHHS will also be seeking foundation grants to support the 10% state match of some of the HIE projects described in section B.2.

B.2.18. Anticipated Needs: State Laws and Regulations

EOHHS, OHIC and RIDO have initiated discussions related to changing RI's consent model for Currentcare. The model being considered is referred to as "consent to view/disclose" and would allow all providers to send their data to Currentcare and individuals would need to consent to who the data could be disclosed to. Currently there is a legal analysis underway at both the state and RIQI to determine if statutory changes are needed to the HIE act of 2008, if regulatory changes are needed or if it is just a matter of

policy changes. If statutory changes are needed, EOHHS is prepared to work with the governor's office to have legislation introduced to achieve this. Such a change would allow Currentcare to be leveraged and used for a significant amount of public health purposes including serving as a CEHRT component for public health reporting of MU requirements.

In the 2016 legislative session, a bill was passed which requires the update and administrative simplification of all existing regulations. This will include updating the HIE and HealthFacts RI regulations. This opportunity will be used to clarify and simplify some components of the regulations which have proven to be unintentional barriers. For example, the HealthFacts RI regulations have limited the sharing of certain data elements which do not necessarily put privacy at risk and could prove valuable to analysts.

There has been some initial discussion with SIM technical assistance staff at ONC about the integration of claims and clinical records. There are legislative barriers which prevent this integration in Rhode Island, notably that HealthFacts RI is a de-identified data set with extensive sharing restrictions, and the HIE is only a partial clinical data (due to having slightly less than half of the state enrolled). These restrictions would not necessarily serve all the needs that could be met with an integrated claims and clinical system on all patients (such as risk assessment on an entire patient panel).

EOHHS will continue to discuss the options for legislative change with stakeholders in the community and determine if there is consensus to seek these types of changes to our HIT legislation.

C. Administrative Oversight of the EHR Incentive Program

C.1. Verification of Eligible Providers

C.1.1. Eligible Providers

Eligible providers are categorized into two broad groups- Eligible Professionals (EP) and Eligible Hospitals (EH). To receive the initial payment, EPs and EHs must adopt, implement or upgrade (AIU) to Certified EHR technology, meet a specified Medicaid patient volume, and be one of the eligible professionals or facilities. To receive subsequent annual payments, EPs and EHs must demonstrate meaningful use of the EHR technology. The eligibility requirements and the state's methods for verifying that they are met follows final rule CFR42 requirements.

C.1.2. Eligibility Requirements and Verification of Eligible Professionals

Eligible Professionals are individuals who are fully enrolled in the Rhode Island Medicaid program, are free from sanctions, do not render more than 90% of their covered services in a hospital (non-hospital-based); and are licensed or eligible to practice their profession in the state as one of the following:

1. A physician,
2. A pediatrician,
3. A dentist,
4. A certified nurse-midwife,
5. A nurse practitioner, or
6. A physician assistant who practices in a rural health clinic (RHC) that is led by a physician assistant.

To receive an incentive payment, eligible professionals must first register at the CMS Registration and Attestation System (R&A) and indicate that they want to apply for a Rhode Island Medicaid EHR Incentive. The R&A then sends a B6 file to the Rhode Island MMIS. It is then matched to the Medicaid provider's NPI to locate whether an active Medicaid provider record exists within the MMIS. Between MAPIR and the provider account in the MMIS, it is determined whether the provider is an eligible professional (EP) based on the Medicaid provider type and specialty.

If a match is found, MAPIR creates a record and sends an email to the provider email address provided in the B6 file to invite the provider to attest for the RI Medicaid EHR

Incentive. This email has a link for the eligible professionals to log into MAPIR via the MMIS web portal. If a match is not found, the provider will not receive an email from our system and will not be able to enter an attestation. Our program administrative staff will contact the provider and inform them that they need to register as a Medicaid provider in order to participate in the program. In the first few years in the program, this was typical with a Nurse Practitioners who do not bill their services directly to Medicaid, however, once the provider completes the Medicaid registration in the MMIS, the provider will be able to participate in the program. This approach strengthens our ability to prevent fraud and abuse and prevent anyone from access the system without validity.

C.1.3. Eligibility Requirements And Verification of Eligible Hospitals

Eligible hospitals are acute care hospitals, critical access hospitals and children’s hospitals. Like EPs, eligible hospitals first register at the National Level Registry. The R&A determines if the hospital/applicant is an eligible hospital based on the following:

- Acute Care and Critical Access Hospitals- have a CMS Certification Number (CCN) with the last 4 digits of 0001 – 0879 or 1300 – 1399.
- Children’s Hospital-have a CCN with the last 4 digits of 3300 – 3399.

Once the hospital has been determined eligible, the R&A sends the registration to the eligible hospital. It is matched by MAPIR to the MMIS like the EPs and a record is created in MAPIR if a match is found.

C.1.4. Identification of Hospital-Based Providers

As described in C.1.2, the MMIS provider record is used to determine whether or not eligible providers are hospital-based by confirming the provider type and specialty.

C.1.5. Verification of Overall Content of Provider Attestations

As described in B.10 the EHR Incentive Program Manager oversees the execution and operations of the RI Medicaid EHR Incentive Program. This position is primarily responsible for ensuring that providers are meeting the CMS guidelines as set forth in the final rule. More specifically this position oversees program outreach activities, policy development and implementation of MAPIR to support the various stages of MU attestation, and pre-payment review and approval. The Program Manager is currently provided by Conduent (previously Xerox Healthcare) and is contracted by EOHHHS.

C.1.6. Communication to Providers

Communication to providers about the EER incentive program happens through various channels and is primarily the responsibility of the program manager. Outreach to providers occurs through a monthly Medicaid provider newsletter which is developed by HPE team who is RI's Medicaid fiscal agent. The EHR Incentive program manager, HPE staff that support MAPIR, and RIQI will develop articles or communicate program updates about MAPIR and the EHR incentive program as part of the Medicaid Monthly newsletter.

Under a contract with EOHHS (aka, RI Medicaid), RIQI has been providing technical assistance to Medicaid providers by assisting them to meet and attest to meaningful use. They provide ongoing communication, conduct training and webinars to the provider community. Additionally, RIQI supplies a great deal of information about meeting AIU and meaningful use that is available from their website's provider knowledge center section. EOHHS also has a dedicated website pages that provides up to date program information to the provider community. Lastly, if there is an important announcement or deadline, the program manager will send a blast email to those participating in the program to inform them of important events, program changes and deadlines.

C.2. Calculating Patient Volume

C.2.1. Patient Volume Requirements for Eligible Professionals

To qualify for an incentive payment EPs must meet the required Medicaid patient volume or medically needy volume if practicing predominately at a Rural Health Clinic or a Federally Qualified Health Center. Patient volume is calculated by dividing the number of Medicaid encounters by the total number of patient encounters over a continuous, 90-day period in the prior calendar year, or, effective, 1/1/2013 for the 2013 program year and beyond, a 90-day period in the preceding 12 months during attestation.

For the purposes of this program, an encounter is any one day where Medicaid paid for all or part of the service or Medicaid paid the co-pays, cost-sharing, or premiums for the service. However, effective January 1, 2013 for program year 2013 and beyond, that definition was expanded to include all encounters with a Medicaid enrolled patient, paid or unpaid. EPs can attest to the required patient volume using encounters attributable to Medicaid that are services rendered on any one day to a Medicaid enrolled individual regardless of payment liability. This will include zero pay claims and encounters with patients in Title XXI funded Medicaid expansions and in the state of Rhode Island that includes CHIP program encounters. CHIP encounters are not identifiable because they do operate separately from the Medicaid Title IX program. As noted in the diagram below Eligible Professionals are required to meet Patient Volume thresholds.

Non Hospital Based Eligible Professionals	90-day Medicaid Patient Volume Percentage Requirement
Physician	30%
Pediatrician	20%
Dentist	30%
Certified Nurse Midwife	30%
Nurse Practitioner	30%
Physician Assistant in a Rural Health Clinic so led by a Physician Assistant	30%

Note: Eligible professionals practicing at least 50% of the time in an RHC or FQHC can include “needy individuals” in the Medicaid numerator when calculating patient volume. EPs that practice at an RHC or FQHC can use encounters attributable to needy volume. EPs have the option to choose whether they will use their individual patient volume or their group’s patient volume to determine if they have met the required Medicaid patient volume.

C.2.2. CHIP Patient Volume Reduction for Program Years 2011 & 2012

As is the case in many other states, Rhode Island's Medicaid program beneficiaries utilize the same identification cards for Medicaid and CHIP, so there is no way for a provider to distinguish which program the beneficiary is in. As noted in the final rule (page 44489 - 44490 of the Federal Register/Vol. 75, No. 144/July 28, 2010/Rules and Regulations), the methodology for estimating Medicaid patient volume is based on Medicaid and not CHIP enrollment. To address this inability to distinguish Medicaid/CHIP enrollment on the basis of available data, CMS has prescribed an approach to adjust patient volumes for impacted providers who apply for the program.

At the start of the Medicaid EHR Incentive program, the final rule required state programs to implement a rule that would reasonably remove any Children's Health Insurance Program (CHIP) activity from the Medicaid Patient Volume because CHIP was not considered a Title IX program. The CHIP reduction would be applied to the Medicaid Patient Volume numerator. This reduction was applied to all EPs, however those providers who did not provide care to children could elect to not apply the reduction should it place them below the patient volume threshold requirement and provide proof that the patients they encountered were not younger than 18 years.

For 2011 & 2012 a CHIP reduction factors were developed using the total number of CHIP child beneficiaries in each county and the total number of Medicaid child beneficiaries in each county. By dividing the two amounts, percentage reductions were computed for each of the five Rhode Island counties. The 2011 and 2012 percentages were based on enrollment data as of December 31, 2010 and December 31, 2011, respectively.



RI CHIP Reduction Rates		
County	2011	2012
Bristol	12.3%	18.3%
Kent	13.1%	17.6%
Newport	11.4%	14.8%
Providence	10%	12.7%
Washington	11.3%	16.8%

CHIP Reduction Example:

Over a 90-day period in the previous calendar year a pediatrician claims to have a total of 2,468 encounters and 747 of those encounters were for Medicaid beneficiaries. The practice is located in Providence County and will incur a CHIP reduction of 10%. The following calculation will be performed to determine the adjusted Medicaid Patient Volume requirement:

$$747 - (747 * 10\%) = 672$$

$$672/2,468 = .2722 = 27\%$$

27% adjusted Medicaid Patient Volume will qualify the pediatrician for 2/3 of the total incentive payment amount.

In 2013 CMS issued [FAQ 7537](#) (click on hyperlink) that allowed states without a standalone CHIP program can include CHIP encounters as part of their Medicaid patient volume. As a result, the CHIP reduction was eliminated for program on or after 2013.

C.2.3. Attestations using Individual Patient Volume

Each attestation the provider can decide to determine program eligibility on an individual or group basis. The individual option is based on the provider's NPI entered in MAPIR and their program year application. As noted earlier, providers must meet a 30% (20% for Pediatricians) Medicaid Patient volume threshold.

MAPIR will allow the provider to enter the 90-day period from either the previous calendar year or twelve months preceding the attestation date. In addition, MAPIR will ask the applicant to enter patient volumes for all the provider's practice locations for the specified time period and whether each location utilized certified EHR Technology. To complete the Patient Volume attestation, the applicant is asked to enter the Medicaid encounters (numerator) and total encounters (denominator) for the individual provider. MAPIR will not allow the application to proceed if the percentage falls below the threshold. However, MAPIR rounds upward if the amounts fall within 0.5%.

C.2.4. Attestations using Group Patient Volume

As noted in the final rule § 495.306 (h), clinics or group practices are permitted to calculate patient volume at the group practice/clinic as defined in the Medicaid MMIS. The MAPIR system allows enrollees to enter their patient volumes using their group practice affiliation based on the Group's NPI as defined in the MMIS.

The practice EPs must use only one methodology (Individual, Group or Patient Panel) in each program year. The practice group must use the entire practice's patient volume and not limit it in anyway. Should an EP practice in both group and outside the group practice, then the practice patient volume will include only those encounters associated with the group.

C.2.5. Attestations using Patient Panel

On a case by case level, we will allow providers to attest using a patient panel approach. The EP will need to submit a patient roster listing for a 90-day period that shows more than 30% of patients on their panel are Medicaid beneficiaries.

While MAPIR is scalable to allow patient panel attestations, we have elected not to activate this option because of its infrequency. However, should we find patient panel attestation increase in occurrence, we would then consider activating this option in MAPIR. In addition, if a provider or provider group find it easier to submit a patient

panel, they can submit a request in writing and we will accept a patient panel listing as part of their patient volume attestation.

C.2.6. Volume Requirements for Eligible Hospitals

Acute care hospitals and critical access hospitals must have an average length of patient stay of 25 days or fewer and have at least a 10% Medicaid patient volume. Children's hospitals do not have a patient volume requirement.

The calculation for patient volume is the Total Medicaid patient encounters in any representative continuous 90-day period in the previous hospital fiscal year / divided by Total patient encounters in that same 90-day period] * 100. For purposes of calculating hospital patient volume, the following are considered Medicaid encounters:

- From 2011 – 2012, services rendered to an individual per inpatient discharges where Medicaid or a Medicaid demonstration project under section 1115 paid for part or all of the service or part of their premiums, co-payments, and/or cost-sharing.
 - However, starting in 2013, as long as the individual was an active Medicaid beneficiary at the time of discharge, they would be considered a Medicaid encounter;
- From 2011 – 2012, services rendered to an individual in an emergency department on any one day where Medicaid or a Medicaid demonstration project under section 1115 of the Act either paid for part or all of the service; or part of their premiums, co-payments, and/or cost sharing.
 - However, starting in 2013, as long as the individual was an active Medicaid beneficiary at the time at the time when services were rendered to an individual in an emergency department, they would be considered a Medicaid encounter;

Eligible Hospitals can attest a combined patient volume for both inpatient discharges and services rendered in an emergency department or for any one previously mentioned categories as long as the numerator and denominator are calculated in the same manner. On the following page is a screenshot of an example of a Hospital Patient Volume attestation from MAPIR.

Patient Volume (Part 1 of 3) - 90 Day Reporting Period				
Start Date: Jan 01, 2013				
End Date: Mar 31, 2013				
Patient Volume (Part 2 of 3) - Enter Volume				
Provider ID	Location Name	Address	Encounter Volumes	% Medicaid Discharges
001, 04	████ COUNTY █████ HOSPITAL	████████████████████ ATE ROAD RI ██████████ 0000	In State Medicaid: 820 Other Medicaid: 13 Total Discharges: 3674	23%
002, 04	████ COUNTY █████ HOSPITAL	████████████████████ ROAD RI ██████████ 0000	In State Medicaid: 3313 Other Medicaid: 90 Total Discharges: 13214	26%
Sum In-State Medicaid Volume	Sum Other Medicaid Volume	Total Discharges Sum Denominator	Total %	
4133	103	16888	25%	

As noted on our SMHP Addendum submitted on January 15, 2016, Eligible Hospitals will attest on a calendar year basis starting in 2015. In previous years, EHs attested meaningful use based on the Federal Fiscal Year (October – September). As a result, our program will accept 2015 meaningful use attestations with patient volumes from October 1, 2014 to December 31, 2015.

C.3. Verifying Patient Volume

C.3.1. Verification of Patient Volume for Eligible Professionals

Whether an application has an individual or a group patient volume entry, each application is required to enter a 90-day Medicaid patient volume amount and a 90-day total patient volume amount. The screen shot below is an example of the patient volume entry screen for an application:

Patient Volume 90 Day Period (Part 2 of 3)					
Start Date: Oct 01, 2014					
End Date: Dec 29, 2014					
Patient Volume Individual (Part 3 of 3)					
Utilizing Certified EHR Technology?	Provider ID	Location Name	Address	Encounter Volumes	%
Yes	005, 04	LE [REDACTED] C [REDACTED] MD	1 [REDACTED] R AVE STE205 C [REDACTED] RI 02 [REDACTED] 0000	Medicaid Only In State: 425 Total Medicaid: 425 Denominator: 1208	35%
Sum Medicaid Only In State Encounter Volume (Numerator)		Sum Medicaid Encounter Volume (Numerator)		Total Encounter (Denominator)	Total %
425		425		1208	35%

Once the application is submitted a data query request is sent to MMIS for the 90-day patient volume period based on an individual or group practice attestation. The Patient Volume query counts total encounters for attesting provider in Rhode Island's MMIS database, which consist of 'Fee for Service' and 'Managed Care' Medicaid claims data. The query used varies by attesting provider application type; EP/EH/EP-Individual/EP-Group. Encounter calculations are further refined to insure only unique data points are observed within attesting provider's given Patient Volume date range.

As further defined in our Audit Strategy, this first level of review compares the query results against the "Medicaid Only In State" amount to determine if the amounts align. Should the amounts not align, the next step is to request a detailed patient volume listing from the provider or provider group that reflects their 90-day patient volume attestation. A detailed patient volume listing is usually requested for provider types that submit claims under a supervising physicians in which the query cannot effectively return a reasonable or auditable amount. Circumstances in which cause disparities with our first level of review are typically from

- Behavioral Health Providers who bundle their claims and all service dates (encounters) cannot be counted.
- Nurse Practitioners and Certified Nurse Midwives may bill under a supervising physician.

- Providers who bill on a Global Billing rate are likely to have more encounters than what was planned for billing.

More claims are submitted because amounts could be billed to a supervising physician, claims are bundled common to behavioral health providers.

During the prepayment review process, the patient volume listings are evaluated to ensure that the patient volume meets the threshold requirements. We also perform a sample validation of Medicaid beneficiaries from this listing to confirm the patient was active at the time of the encounter date. A second level of patient volume listing review is also performed by the Program Integrity group when a patient volume falls below the 30% or 20% threshold or if it is within 3% above the threshold.

C.3.2. Verification of Volume for Eligible Hospitals

The administrative staff verify that acute care hospital meets the average length of stay of less than 25 days' requirement by using the cost reports submitted to Medicaid for rate setting purposes.

Similar to Eligible Professional Patient Volume attestations, MAPIR query counts total encounters for attesting provider in Rhode Island's MMIS database, which consist of 'Fee for Service' and 'Managed Care' Medicaid claims data. The query used varies by attesting provider application type; EP/EH/EP-Individual/EP-Group. Encounter calculations are further refined to insure only unique data points are observed within attesting provider's given Patient Volume date range.

The query results are compared to the attestation during the pre-payment review process. Similar to the EP attestation, a patient volume listing is requested if the query result does not align to the amounts on the MAPIR attestation screen. This listing will be evaluated to ensure that the patient volume meets the threshold requirements. We also perform a sample validation of Medicaid beneficiaries from this listing to confirm the patient was active at the time of the encounter date. In addition, a second level of patient volume listing review is also performed by the Program Integrity group when a patient volume falls below the 10% threshold or if it is within 3% above the threshold.

C.3.3. Verification That Eligible Professionals Meet the Practices Predominantly Requirement

In most cases, our FQHC's meet the initial 30% Medicaid patient volume requirements. However, if there is an instance where they need to use the practice predominately option to meet the 30% requirement, we will request a "Needy Individual" patient volume listing from the provider or provider group for the given 90-day patient volume period. This list will be used to validate this portion of the patient volume requirement.

C.3.4. Verifying AIU – Adopt, Implement or Upgrade Certified EHR Requirements

MAPIR accepts provider attestations for the AIU component of the incentive payment. During registration, MAPIR requires providers/applicants to attest that they have adopted, implemented or upgraded to a certified EHR technology and to provide a valid EHR certification number. MAPIR verifies the certification number through an interface with Office of the National Coordinator's (ONC) Certified Health IT Product List (CHPL). If the certification number is invalid, MAPIR will not allow the application to proceed.

Providers are also required to upload copy of a business record that demonstrates the provider has purchased or contracted with a third party the EHR system. The administrative team reviews the business record during prepayment review before authorizing payment.

A business record for the documentation for ***purchased*** systems must include the following elements:

- The provider's name
- The system name and version
- The financial obligation
- A timeframe for adopt, implement or upgrade

Examples of documentation for ***purchased*** systems are:

- Copy of a paid invoice from the CEHRT vendor;
- Executed upgrade agreements for which a cost and timeframe are stated;
- A CEHRT vendor letter ***only*** if it contains the provider name, the system name and version, the financial obligation, a timeframe for adopt, implementation or upgrade, and is signed by the vendor. The vendor letter in essence becomes a legally binding document such as a contract or agreement.

A business record for the documentation for “*free*” EHR systems may include:

- A copy of the license agreement with the CEHRT system.
- A copy of the EHR system’s screen that displays at a minimum the provider’s name and the name of the free CEHRT software.
- A vendor letter is acceptable if it contains the practice name and/or the provider’s name; the name of the software and the version of the software.
- The “welcome email/letter” that is sent by the CEHRT vendor upon signing up.

A business record for documentation of arrangements in which the EHR system from another practice is used:

- A copy of the agreement between the owner of the system and the applicant indicating the name and version of the software
- A screenshot from the EHR system indicating the software’s name and version

C.3.5. Verifying Meaningful Use Requirements

To receive payments for meaningful use eligible providers must demonstrate meaningful use of their EHR technology.

From 2011 – 2013 Meaningful Use Requirements were as follows:

EPs had to report on 20 of 25 Meaningful Use Objectives which include 15 core and 5 out of 10 menu measures for Stage 1, but for Stage 2 EPs had to report 17 core and 3 out of 6 menu measures. In addition, all meaningful use attestations required at least six clinical quality measurements (CQM) to be reported from the certified EHR technology.

EHRs and CAHs had to report on 19 of 24 Meaningful Use Objectives which included 12 core measures and 5 out of 10 menu measure. In addition, all 15 CQM measures needed to be reported from their certified EHR technology. EHRs who had attested for meaningful use via the Medicare EHR Incentive program were deemed eligible for the Medicaid meaningful use EHR incentive payment and can receive payments from both Medicare and Medicaid.

Meaningful Use reporting periods for the first year of MU reporting was for any 90-day period. Subsequent years a full year (365 days) of meaningful use reporting was required for each program year.

On December 15, 2015, Meaningful Use requirements were modified. CMS issued a final rule that reduced the meaningful use measure requirement for program years 2015 – 2017. The meaningful use measures were set to Stage 2 level requirements for all

meaningful use attestations, reduced the number of measures to ten and eliminated the menu set measures. For program year 2015, providers were able to attest for 90-days of meaningful use and if they were scheduled to do Stage 1 for 2015, they could attest meaningful use with alternate measures.

In spring 2016, MAPIR was upgraded to accept the 2015-2017 Modified Meaningful Use rule changes. An SMHP addendum for this change was submitted to CMS on February 9, 2016.

C.3.6. Proposed Changes to the MU Definition

There are no proposed changes to the MU Definition as permissible per rule-making at this time.

C.3.7. Verification of Providers' Use of CEHRT

As described in C.8., MAPIR verifies the certification number through an interface with Office of the National Coordinator's (ONC) Certified Health IT Product List (CHPL). If the certification number is invalid, MAPIR will not allow the application to proceed.

C.3.8. Collection of Providers' Meaningful Use Data

For the past 5 years, Rhode Island has contracted with HPE to provide MAPIR, the state level registration tool for the RI Medicaid EHR Incentive program. MAPIR is a web-based application that allows providers and/or their delegates to complete EHR Incentive Attestations. MAPIR was designed and developed by a thirteen multistate collaborative workgroup to accept applications and distribute payments to eligible providers.

We do not anticipate changing the method of data collection at this time, with the possible exception for the collection of electronic clinical quality measures which may be collected for some providers through the Electronic Clinical Quality Measurement Reporting and Feedback System described earlier.

C.4. Alignment of Data Collection and Analysis Processes

As mentioned above, as part of RI's SIM efforts, the state embarked on and facilitated a measure alignment process. The purpose of this initiative was to create a harmonized set of measures in order to streamline and reduce the total number of different measures providers need to report on. EOHHS contracted with Ballit Associates to facilitate the community process which engaged a large number of provider and payer stakeholders. In order to scope the project, the aligned measure set was developed to be used for by payers with providers in contracting. Representatives from Medicaid participated in this process and as a result there were some measures identified to be specific Medicaid measures. The process included looking at many existing measures sets used by providers including meaningful use (MU) measures. The final measure set include a core and a menu set of measures. Not all of the final measures chosen align with MU but many do. The menu set is updated annually and will continue to evolve over time. As described previously in this document, the state is also embarking in developing a ECQM reporting and feedback system which will obtain data directly from EHRs, calculate a variety of measures including the aligned measure set and all MU measures, benchmark and feedback the measures to providers and their organizations and send them to those agencies for whom they need to be reported to. This process will help to standardize data collection and analysis across program and in a manner which has not previously been done.

C.4.1. IT Systems Used to Implement the EHR Incentive Program

As described in C.12. Rhode Island uses MAPIR as its IT system to implement the EHR Incentive Program. MAPIR integrates with the state's Medicaid Management Information System (MMIS) and receives files from CMS' Registration and Attestation (R&A) system, a.k.a. the NLR (National Level Registry).

Eligible providers or their designees access MAPIR using Rhode Island's MMIS provider web portal. During registration they are asked to attest that they meet all the requirements for payment and to upload documentation that supports their attestation. The EHR incentive payment administrative team reviews the submitted documentation as well as other information that validates the provider's eligibility. The administrative team then authorizes or denies payment based on their review. MAPIR sends a file to the CMS R&A system for validation and payment approval. If the provider has been approved to receive a payment, the R&A validates the provider has not received payment in another state or from Medicare, and notifies the state to proceed with paying the provider. MAPIR then electronically pays the provider using the MMIS financial system.

The MAPIR system will provide the majority of the necessary technical functions to implement the EHR Incentive Program. MAPIR integrates with the State's MMIS and links to the CMS Registration and Attestation System (R&A). The R&A has the functionality to guard against duplicate provider payments.

Data transfers and interfaces between MAPIR, the R&A, and MMIS will determine provider applicant eligibility. Upon submission of a completed registration for a Medicaid EHR Incentive payment. Upon program administrative approval, the MMIS will issue the incentive payment to eligible professionals and hospitals once program regulations for payment have been met. Our MAPIR system will track and monitor application and payment information. MAPIR also communicates with registrants on the status of their application via an email address provided by the applicant.

MAPIR has an application user interface for providers who want to submit an EHR Incentive application and an administrative user interface for use by Rhode Island Medicaid EHR Incentive Program support staff. Providers have one point of access via the secure Medicaid Provider Portal. The portal is a communication, data exchange and self-service tool for the Rhode Island Medicaid provider community. Additionally, Rhode Island's Medicaid EHR Incentive Program staff is able to use MAPIR to track application and decision status, enter notes and upload electronic documents to provider applications, and if necessary, generate provider correspondence. When a payment approval has been made, a file (D16) is sent to the R&A, which will then confirm and register the payment from CMS and authorize the state to make the Medicaid EHR Incentive payment. To complete the application process, the MMIS generates an electronic EHR incentive payment that can be identified with a 247 reason code on the providers' RI Medicaid remittance advice.

C.4.2. IT & MAPIR System Changes for Implementation

MAPIR is configurable to our state's systems environment and is customized with state-specific requirements. In the next five years, MAPIR will need to be upgraded to support any changes in the EHR Incentive Program requirements and potentially to connect to other new State HIT Infrastructure such as the clinical quality measurement reporting and feedback system.

C.5. IT Timeframe for Systems Modifications

Since 2011, the MAPIR collaborative and MAPIR development team ensure that release changes comply with statute and regulations approved by CMS and based on past experience, the MAPIR team was able to develop and deploy system modifications within a three to six-month timeframe. This includes system quality assurance testing both on the core and individual state levels.

Moreover, the collaborative conducts weekly meetings to discuss program changes and how they will be addressed within MAPIR. We also communicate any defects the system may have and the MAPIR development team will correct the problem within several weeks with a patch or upgrade.

C.6. Interface with the CMS NLR

The MAPIR systems' interface with the CMS NLR is complete.

C.7. Accepting Registration Data from the CMS NLR

The MAPIR system accepts registration data from the CMS NLR through a daily interface.

C.8. Websites for Enrollment and Program Information

MAPIR is a web-based application that assists providers with enrollment and attestation. The EHR Incentive Program provides other information to providers on the EOHHS website, available at:

<http://www.eohhs.ri.gov/ProvidersPartners/ElectronicHealthRecordsEHRIncentiveProgram.aspx>

C.9. Anticipated Modifications to the MMIS

There are currently no anticipated modifications to the MMIS that will impact the EHR Incentive. However, should an MMIS change impact MAPIR, the MAPIR Collaborative, the MAPIR development team and all local state MAPIR support teams are informed of any changes and address any MMIS or MAPIR issues that could arise.

C.10. Call Centers/Help Desks

Our Fiscal Agent, HPE, who oversees our MMIS administration and support, is available as a first level triage should providers have questions about access to MAPIR or program requirements. The program manager is the second level triage for issues that cannot be resolved by the first level. The program manager has technical support from HPE should back door corrections are needed for MAPIR and/or the MMIS.

C.11. Appeals & Administrative Redetermination

Providers may request appeals regarding eligibility determinations, incentive payments, and determinations regarding the demonstration of adopting, implementing, or upgrading and meaningfully using certified EHR technology using MAPIR.

Appeals will initially be handled via the re-determination function in MAPIR. Once a provider has followed the appropriate steps, the administrative staff will assess the information and render an Administrative Re-determination. Decisions that stand as originally rendered, yet are still disputed by the provider, will be referred to the Agency's Office of the General Counsel and required to follow the state's administrative procedure for formal appeals.

In most disputes an informal discussion is first recommended. This discussion allows the state HIT coordinator who oversee the EHR incentive program to discuss the situation with the provider and program staff and determine if there is any resolve within the confines of the federal program regulations. If the outcome is still unsatisfactory to the provider an informal and/or formal administrative appeals are offered. The informal appeal allows both parties along with legal counsel to present their case. Should the state render an unfavorable decision, a formal appeal can be requested in writing and within 15 calendar days of a written notice. The appealing party must send this written request to the Office of Appeals and include a "Request for a Formal Hearing" form (DHS-121). Should an unfavorable decision be rendered, the provider can pursue the final step and request the decision be appealed and entered by the hearing officer for judicial review. A complaint with the Superior Court must be filed within thirty (30) days of the date of the formal decision in accordance with RIGL 42-35-15.

C.12. Assuring that Federal Funding is Accounted for Properly

EOHHS has a fiscal unit and team that works to assure that all federal funding is accounted for properly. The EHR incentive program has its own federal as well as state match accounts and all charges for this program are charge to those accounts. There are processes in place so that when vendors such as HP or RIQI submit bills, a program person reviews and signs off on the bills prior to them being paid. Any staff, such as the state HIT Coordinator whose time is partially allocated to this program tracks their time in 15-minute increments as part of EOHHS Medicaid cost allocation.

C.13. Anticipated Frequency of EHR Incentive Payments

C.13.1. Process to Issue Incentive Payments

Payments are issued according to existing MMIS processes. EPs and EHs meeting program requirements will be paid an incentive payment unless they have been sanctioned or excluded from receiving payments or previously received payment from Medicare or another state.

The following table shows the activities and actors associated with issuing a payment.

Disbursing EHR Incentive Payments			
Activity	System Activity	Personnel Activity	Personnel Involved
Verify Payment Meets Requirement	Attestations information are verified against program requirements prior to submission and payment	EP or EH attest to meeting program requirements	Eligible Professional (EP), Eligible Hospital (EH), EHR Incentive Program Staff
Verify Assignment is Voluntary	With an electronic signature, MAPIR captures information for EPs who have assigned their incentive payment to verify that the assignment was voluntary.	The EP/EH attests at the SLR, MAPIR, if the payment is voluntary. If not, payment is withheld and EP/EHs can change Payee selection at the CMS R&A system	Eligible Professional, Eligible Hospital
Confirm Payment with CMS' R&A prior to disbursing payment	MAPIR interfaces with the R&A and sends a D16 payment notification file. MAPIR receives a payment confirmation (D18) to proceed with EHR Incentive payment. This activity prevents payments being made by another State or Medicare	Not Applicable	Not Applicable
Disburse Payment	MAPIR issues an electronic incentive payment via an MMIS Remittance Advice with a 247 Reason Code	Payee TIN/Assignee receives payment as noted on the EP/EH incentive application	Payee Assignee

C.13.2. Incentive Payments for Eligible Professionals

Eligible professionals can receive an annual payment over six years for the adoption, implementation and meaningful use of an EHR technology. Payments are made once in a calendar year, however EPs do not have to apply for payments in consecutive years and are allowed to skip payment years.

Eligible professionals can register to receive the payment directly or reassign payment to a Medicaid enrolled group provider with which they have contractual arrangement that allows the group to bill and receive payment for the EP's covered professional services.

The following chart displays the payment amount for AIU and meaningful use that is available during the program.

Payment Year	Maximum Payment	EHR Attestation Requirement
Year 1	\$21,250	Adopt, Implement, Upgrade or 90 consecutive days of Meaningful Use
Year 2	\$8,500	90 or 365 consecutive days of Meaningful Use
Year 3	\$8,500	365 consecutive days of Meaningful Use
Year 4	\$8,500	365 consecutive days of Meaningful Use
Year 5	\$8,500	365 consecutive days of Meaningful Use
Year 6	\$8,500	365 consecutive days of Meaningful Use
Total	\$63,750	

Note: Due to program rule changes, Program Year 2014 & 2015 only required a demonstration of 90 days of Meaningful Use. In addition, annual payment amounts are reduced by 2/3 for pediatricians whose patient volume falls below 30%, but is over 20%.

For payment years two through six, EPs will attest to Meaningful Use according to the applicable rule. EPs will attest to two years of Stage 1 measures, followed by two years of Stage 2 measures. EPs that skip a year will also have two years at each stage. Requirements for subsequent stages have yet to be determined. The online application will be updated to comply with all changes in rule.

D.13.3. Incentive Payments for Eligible Hospitals

Incentive payments to eligible hospitals are based on a complex formula in which a base incentive amount of \$2,000,000 for each hospital is modified by the number of Medicaid discharges, bed days and other factors. Eligible hospitals can receive incentive payments over 3 years. The allocation of the aggregate hospital incentive payment will be 50% in the first participation year, 40% in the second, and 10% in the third. Hospitals participating in multiple states must choose only one state to receive payments from. Additionally, hospitals meeting Medicare meaningful use requirements are deemed eligible for Medicaid incentive payments and can receive payments for both Medicare and Medicaid.

MAPIR calculates the incentive payment for hospital based on the data entered by the hospitals. For verification, the administrative staff compares the submitted data to the data taken directly from the hospital cost reports. Any discrepancies between the submitted cost report and what was entered in their MAPIR attestation are resolved before incentive payments are issued.

The Rhode Island Medicaid EHR Incentive Payment hospital aggregate incentive amount calculation will use the equation outlined in the proposed rule, as follows:

$$\text{(Overall EHR Amount) times (Medicaid Share) where Overall EHR Amount Equals}$$
$$\{\text{Sum over 4 year of [(Base Amount plus Discharge Related Amount Applicable for Each Year) times Transition Factor Applicable for Each Year]}\} \text{ times Medicaid Share Equals}$$
$$\{[(\text{Medicaid inpatient-bed-days plus Medicaid managed care inpatient-bed-days}) \text{ divided by } ((\text{total inpatient-bed days}) \text{ times } (\text{estimated total charges minus charity care charges})) \text{ divided by } (\text{estimated total charges})]\}$$

The amounts for the above formula are pulled from the Eligible Hospital's cost report for the first year of participation and verified by the review staff prior to payment. Should the year's cost report data fields used to calculate the total hospital incentive be adjusted or corrected will require an update to the incentive payment amount. Each application year, MAPIR offers the attester to enter revised cost report entries and will automatically adjust the total EHR Incentive for the hospital.

C.13.4. Other Considerations

Not at this time.

C.13.5. Reporting Medicaid EHR Incentive Payments to CMS

Within each quarter, Rhode Island Medicaid EHR Incentive payments are report to the CMS 64 report. Payments to eligible hospitals, FQHCs and eligible professionals are reported separately.

C.13.6. Incentive Payment Recoupment

In the event RI Medicaid EHR Incentive program determines that disbursements have been inappropriately or inaccurately made, the existing refund process will be leveraged to recover the funds. MAPIR currently has the ability to perform an adjustment transaction to certain program year's application or to all program years the provider has participated. MAPIR will create a transaction file for the recoupment which will result in an Accounts Receivable (AR) record that will be associated with the appropriate provider. The provider would then be requested to directly refund the appropriate incentive amount. To date there have been no payment recoupments. This likely due to having implemented an intensive prepayment audit and verification process conducted by the EHR program manager. In several instances the program manager has had to recommend providers abort their application because they did not pass the prepayment audit process. this has occurred after the program manager has worked extensively with the provider to determine if they have sufficient evidence to pass the pre-audit. Examples of a provider have had to either be denied payment or abort their application include inability to verify and prove sufficient patient volume, or sufficient documentation for a security risk assessment.

C.13.7. Assuring the Recipient of Medicaid Provider Payments

MAPIR is our system that manages our RI Medicaid EHR Incentive program and is fully integrated with our MMIS. If a provider is not entered as an active Medicaid provider, they will not be able to apply for a RI Medicaid EHR Incentive. If a provider does want to apply, they will need to register as a Medicaid provider via the MMIS registration system.

C.13.8. Assuring Payments Used to Promote the Adoption of Certified EHR Technology

MAPIR validates each application of its ONC EHR certification during the application process. As previously mentioned, our program requests a copy of a paid invoice or written validation that the provider has access to the certified EHR technology. After payments are issued, we circulate electronic communication or provide events to educate our provider community on how they can meet meaningful use.

C.13.9. Dispersing EHR Incentive Payments through Medicaid Managed Care Plans

Usually on a bi-weekly basis, Rhode Island Medicaid electronically disperses the EHR Incentive payments directly through its MMIS system and does not disperse the payments through Medicaid Managed Care Plans.

C.13.10. Assurance that Calculations and Incentives Are Consistent with Statute and Regulations

With our 13-state MAPIR collaborative and access to our CMS regional manager, we are provided with solid guidance that assures we are in compliance with regulations. Rhode Island is very active with the Community of Practice programs, monthly CMS All-State calls and CMS quarterly and annual meetings. In addition, the program manager and the MAPIR collaborative share regulation information that come through the CMS listserv or during the proposed rule-making process.

In addition, our MAPIR collaborative and MAPIR development team ensure that release changes comply with statute and regulations approved by CMS. For instance, the upcoming 2017 release 6.0 will allow our provider community to attest to Stage 3 meaningful use regulations approved on January 1, 2017.

C.14. Role of Existing Contractors with Implementation

The relation of existing contractors with the implementation of the EHR Incentive Program is noted throughout this SMHP. In summary is a list of contractors and the services they implement for our program(s):

- HPE provides technical support for MAPIR and the MMIS.
- Conduent, formally known as Xerox Healthcare, provides EHR Incentive oversight and assures that the program meets regulations set forth by CFR42.
- Rhode Island Quality Institute (RIQI) provides support and outreach to our provider community and have been a great contributor to helping providers meet meaningful use with their certified EHR technology.
- HealthCentric Advisors assists us with understanding our HIT landscape with their bi-annual physician technology surveys.

C.15. Assumptions

CMS will continue to develop and support the National Level Repository, provider outreach and help desk support through the end of the program and that MAPIR will be able to continue to interface with the NLR

ONC will continue to certify CEHRT and EHR vendors will continue to develop their products and pursue certification

Sufficient state match will be appropriated to EOHHS to support the EHR incentive program.

HP will continue to serve as the Medicaid Fiscal agent. The current contract ends in December 2017 and there are three extensions before a re-procurement is required, unless the state chooses not to execute on an optional year. If the vendor changes the state will need to assess how to continue with the EHR incentive program.

RIQI will continue to serve as the states regional health information exchange organizations and operate CurrentCare.

D.Audit Strategic Plan

D.1. Audit Methods

D1.1. Introduction

An effective audit capability is critical to the success of the EHR Incentive Program. This is evidenced by the numerous CMS requirements that either address the audit function by name, or by the many instances of “ensure,” “assure,” and “verify” used to describe the required level of substantiation. Rhode Island EOHHS operates a comprehensive set of audit activities, conducted during pre- and post-payment of Medicaid EHR Incentive applications. This approach provides the level of assurance necessary for the program changes and complexities. The following graphic presents the flow of audit activities surrounding the issuance of eligible professional and hospital incentive payments.

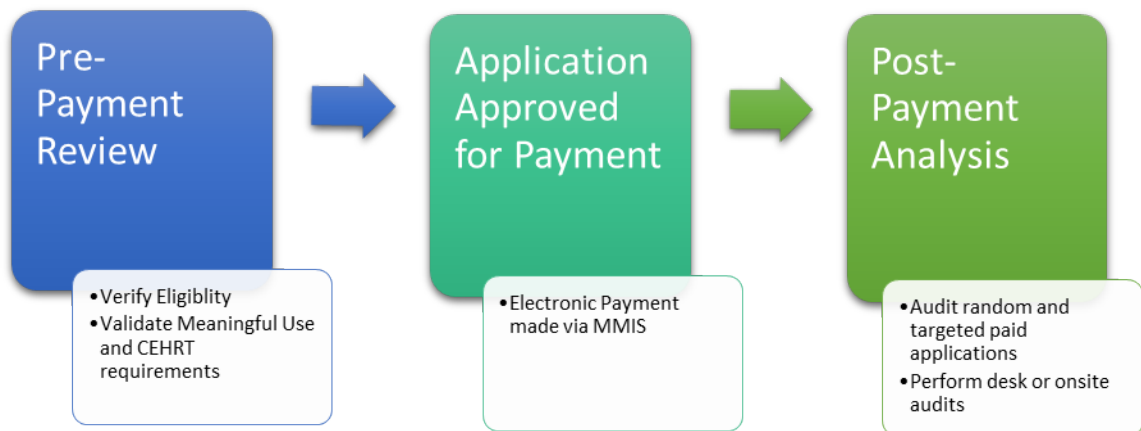

The overall set of business processes proposed for Rhode Island Medicaid EHR Incentive Program (as presented in Section C of the SMHP) reflect a balance between efficiently issuing incentive payments while not issuing inappropriate incentive payments, and protecting against fraud and abuse. The set of audit activities we perform make every attempt to understand both ends of this spectrum.

It is the intent for Rhode Island’s Medicaid EHR Incentive Program audit activities to limit the burden of program participation on eligible professionals and hospitals. Reliance on pre-payment system verifications minimizes disruptions to the daily operations of program participants. On the same premise, post-payment audit verifications will also be carried out in the least intrusive manner possible. However, we will not sacrifice the due diligence necessary to gain an understanding of participant

compliance with program requirements. Our goal, for example, is to perform appropriate desk audits and if necessary conduct an on-site audit so that we can be the least intrusive to our provider community.

D.1.2. Implementation Steps for Audit

MAPIR provides numerous pre-payment verification and auditing controls and supports the level of program integrity as outlined per the CMS Guidelines. Specific program integrity features are embedded throughout the program’s business processes and the audit sub-process also addresses requirements identified in the guidelines. Pre-payment system verifications in combination with random and targeted post-payment audits ensure overall program integrity. Rhode Island EOHHS’ Program Integrity office will conduct post payment audit. The first audit strategy was submitted and approved in October 2013.

At the start of the RI Medicaid EHR Incentive Program, provider attestations were reviewed with a pre-payment review. While this increased the time for payment, issues were addressed in the forefront for each application, especially the obvious ones. Our mission with the program was to trust and validate and not to pay and chase. With an influx of applications to be reviewed by limited staff, we eventually submitted a formal Audit Strategy to CMS in early 2013 as noted in the chart below.

Audit Implementation Tasks	Start Date	End Date
MAPIR Installed – Start of Pre-Payment Review	July 2011	July 2011
Initiated Pre-payment review as defined within in SMHP	July 2011	Ongoing
SMHP Version 1 Approval	June 2010	January 2012
Audit Strategy Development and Approval Version 1	January 2013	April 2013
EHR Incentive Audit Staff hired by Office of Program Integrity	March 2013	June 2013
Random and Targeted Desk Audits	August 2013	Ongoing
Initiate Post Payment Desk Audits	September 2013	Ongoing

D.1.3. Approach to Pre-Payment and Post Payment Audit Activities

The following describes the pre- and post-payment audit activities.

- Pre-Payment Audit Activities rely on the following:
 - Automation between MAPIR and the MMIS
 - Validation of participants’ certified EHR systems providing reliable Meaningful Use and Clinical Quality Measures data
 - Access to internal and external sources of data.

- **Post-Payment Audit Activities** will be conducted on a random and targeted basis to assess provider compliance. The post payment audit selection process and audit activities will largely be manual processes performed by the Office of Program Integrity.

A key to the effectiveness of the EHR Incentive Program will be the extent to which the pre- and post-payment audit activities work together to ensure participant compliance with program requirements. The eligibility verification process detailed in the next section covers the full set of pre-payment audit activities.

Internal and external data sources for prepayment and post payment audit activities include; Rhode Island’s MMIS system, claims, encounters and provider information for eligible providers and eligible hospitals. Hospital cost report data submitted to CMS will be cross referenced. New sources of external and internal data and data sources may be identified while the program is in place. Further details of the audit can be found in the CMS approved audit strategy that was submitted separately and is not available for public use.

D.1.4. Targeted Post Payment Audits

The audit selection pool for post-payment audit will be risk based and composed of providers identified during pre-payment checks that had marginal Medicaid volume. Risk based elements will be identified to assess which AIU and MU measures are likely to be subject to incorrect information. A risk assessment scoring is utilized to identify those providers who are subject to a Rhode Island Medicaid EHR Incentive audit.

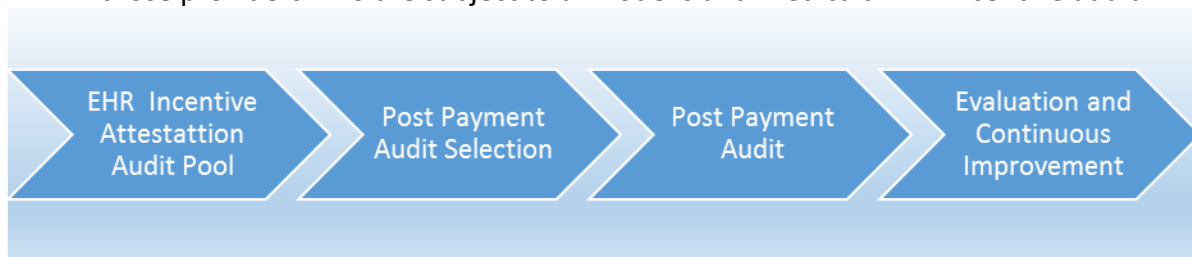

Basic Audit Methodology

D.1.5. Eligibility Verification Process

Eligibility Requirements	EP	EH	Statute	Final Rule	Pre-payment Verification Process and Data Elements	Post-payment Verification
1. EP or EH must be one of the permissible professional or hospital types	✓	✓	42 USC § 1396b(t)(2) (A-B)	§ 495.368 (a)(1)(i) Combating fraud and abuse	<p>Verify that the applicant's provider type meets eligibility requirements.</p> <p>Based on provider type, MAPIR restricts non-eligible providers from applying. However, staff will verify the applicant's provider type in the MMIS provider file.</p> <p>Staff will verify that Physician Assistants (PA) who apply meet the requirement of leading a FQHC or RHC. Staff will attain evidence to confirm FQHC/RHC is so led by a PA.</p>	Random and targeted desk audits or onsite audit activities

Eligibility Requirements	EP	EH	Statute	Final Rule	Pre-payment Verification Process and Data Elements	Post-payment Verification
2. EP or EH must be licensed to practice in the State	✓	✓		§ 495.368 (a)(1)(i) Combating fraud and abuse	MAPIR validates licensure from the Rhode Island MMIS Active licensure can be validated with Rhode Island's Department of Health's license website	Random and targeted desk audits or onsite audit activities
3. EP or EH must be a Medicaid provider in that State.	✓	✓		§ 495.304 (a) Medicaid provider scope and eligibility	MAPIR verifies against the MMIS provider file. If it does not exist, an application cannot be entered.	Random and targeted desk audits or onsite audit activities
4. EP or EH cannot be excluded, sanctioned, or otherwise deemed ineligible to receive payments from the State (i.e. incentive payment made by another State)	✓	✓		§ 495.368 (a)(1)(i) Combating fraud and abuse	MAPIR verifies the MMIS provider file. Additional verification is conducted with CMS' R&A system prior to release of payment.	Random and targeted desk audits or onsite audit activities
5. EP must have at least a 30% Medicaid patient volume (or 20% for pediatricians), unless s/he is practicing predominantly in an FQHC or RHC	✓		42 USC § 1396b(t)(2)(A)	§ 495.304(c)(1) Medicaid provider scope and eligibility	The Medicaid numerator for all EPs will be verified via a MAPIR Query request to the Medicaid MMIS claims database and compared to the EP's application. Staff will contact other states should the applicant's out of state Medicaid patient volume requires validation.	Random and targeted desk audits or onsite audit activities
6. EP must have at least a 30% needy individual patient volume, if s/he is practicing predominantly in an FQHC or RHC	✓		42 USC § 1396b(t)(2)(A)	§ 495.304(c)(3) Medicaid provider scope and eligibility	Should the Medicaid patient volume not meet the required threshold, a needy individual patient volume listing will be requested from the EPs and reviewed prior to payment.	Random and targeted desk audits or onsite audit activities
7. EPs must have more than 50% of his/her patient encounters occur at a FQHC or RHC in a six-month period during the prior calendar year to practice predominantly in an FQHC or RHC	✓			§495.366 (b)(4) Financial oversight and monitoring of expenditures	If necessary, a patient encounter listing from the FQHC/RHC will be requested and reviewed prior to payment.	Random and targeted desk audits or onsite audit activities
8. EH must have at least 10% Medicaid patient volume (acute care hospital only)		✓	42 USC § 1396b(t)(2)(B)	§ 495.304(e)(1) Medicaid provider scope and eligibility	The Medicaid numerator for all EHs will be verified via a MAPIR Query request to the Medicaid MMIS claims database and compared to the EH's application.	Random and targeted desk audits or onsite audit activities
9. EP must not be hospital-based (no more than 90% of his/her Medicaid claims are inpatient with a POS 021)	✓		42 USC § 1395w-4. (a)(o)(1)(C)(i-ii)	§ 495.304 (c) Medicaid provider scope and eligibility	Verification via an MMIS query request that compares POS 021 claims against all claims and ensures that participating providers fall are below 90%. If not, they will be targeted for a post payment audit.	Random and targeted desk audits or onsite audit activities

Eligibility Requirements	EP	EH	Statute	Final Rule	Pre-payment Verification Process and Data Elements	Post-payment Verification
10. EP must practice in a PA-led FQHC or RHC if s/he is a Physician Assistant (PA)	✓		42 USC § 1396b(t)(3)(B)	§ 495.304(b) Medicaid provider scope and eligibility	Staff will verify that Physician Assistants who apply meet the requirement of leading a FQHC or RHC that is PA led.	Random and targeted desk audits or onsite audit activities
11. EH must have an average length of stay of 25 days or less to be considered an acute care hospital		✓		§ 495.332(b)(5) State Medicaid HIT plan requirements	Verification through submitted cost report.	Random and targeted desk audits or onsite audit activities
12. EP or EH must adopt, implement, or upgrade (AIU) certified EHR technology capable of meeting meaningful use	✓	✓	42 USC § 1396b(t)(6)(ii)	§ 495.366 (c) Financial oversight and monitoring of expenditures	Verify attested to status of Adopted, Implemented, Upgrade for the EHR system. The state will accept uploaded documentation that identifies the specific certified EHR technology and coincides with the CMS Certification number provided on the application. The certified EHR technology has been acquired or purchased with the CEHRT vendor, or with third party arrangement. Signed contract and recently paid invoices from the CEHRT are requested.	Random and targeted desk audits or onsite audit activities
13. EP or EH must meaningfully use (MU) certified EHR technology	✓	✓	42 USC § 1396b(t)(6)(ii)	§ 495.366 (c) Financial oversight and monitoring of expenditures	Meaningful Use Reports must be uploaded with the application. Reports must include numerator and denominator measures for Core, Menu and CQM measure sets.	Random and targeted desk audits or onsite audit activities
14. Managed care providers must not receive EHR incentive payment that exceeds 105 percent of their capitated rate if Medicaid is the payer, unless incentives are documented and actuarially sound.	✓		42 CFR 438.6(c)(5)(iii) Special contract provisions. 42 CFR 438.6(c)(4)(B)(iv) Documentation.	§ 495.366 (e)(7) Financial oversight and monitoring of expenditures (See also § 438.6 (c)(v)(5)(iii))	MCOs are not making incentive payments to providers under Rhode Island's Medicaid EHR Incentive program.	Random and targeted desk audits or onsite audit activities

D.2. Identification and Tracking Overpayments

Tracking overpayments to providers is addressed in this section. Incentive payments made inappropriately or fraudulently obtained will be recouped using the existing agency recoupment process. The Agency will comply with CMS guidelines that require the Medicaid Agency to track the total dollar amount of overpayments identified by the State as a result of oversight activities conducted during the fiscal year.

A primary goal of the EHR Incentive Program processing procedure is to limit overpayments to a minimal number, and therefore to a limited amount. The activities that occur during the Eligibility Verification process are designed to prevent overpayments. The Agency acknowledges that regardless of the system, some overpayments or inappropriate may be made. Therefore, audit post-payment activities conducted are intended to identify overpayments. The Agency has a systematic ability to track overpayments on an individual provider basis, and to report on overpayments in the aggregate for a specified time period.

D.3. Fraud and Abuse Mitigation

Potential fraud and abuse issues that relate to the EHR Incentive Program will be investigated by the Office of Program Integrity (OPI). Fraud is defined as any type of intentional deception or misrepresentation made by an entity or person with the knowledge that the deception could result in some unauthorized benefit to the entity, him/herself or some other person. For example, in the case of the EHR Incentive Program, fraud may include the intentional inclusion of false information on the registration and attestation form. Abuse is any practice that is inconsistent with sound fiscal, business or medical practices, and that results in an unnecessary cost to Medicaid. Abuse also includes when a provider misstates a part of their application and attestation form.

OPI will take one of two actions, depending upon whether fraud or abuse is detected:

- **Fraud:** When fraud is suspected, the Program Integrity Group will conduct an investigation. This may include internal discussions with involved parties. If the group finds a credible suspicion of fraud, findings will be summarized and referred to the Medicaid Fraud Department and the Rhode Island Attorney General's office for further investigation.
- **Abuse:** These cases are reviewed and decided upon internally by the Program Integrity Group after an investigation. This will involve activities such as internal discussions with involved parties, discussions with the provider under

review, review of existing data, and review of existing documentation. If the group detects abuse, an administrative action such as requiring a Corrective Action Plan (CAP) and/or recovery of the incentive payment(s) based on the nature of the finding will be initiated.

When fraud or abuse is detected, the group will determine what actions are required on a case-by-case basis. CAPs would be developed for providers who are determined to have violated regulatory compliance. Recoupment activities will pursue any overpayments from fraud or abuse. The provider may also be subject to disenrollment from the Medicaid program and listing on the federal and state sanction provider list.

We anticipate that meaningful use audit findings will be issued on a 'pass-fail' basis. Providers will have an opportunity to remediate identified issues within a 60-day time window; if they are unable to remediate issues, the incentive payment recoupments processes described above will be invoked with respect to penalties. If the audit finds that there was a false attestation by the provider who completed it, a refund amount will be determined and incentive funds, relative to the appropriate incentive stage, must be refunded. If these steps are not completed, providers may face sanction and/or prosecution as per existing processes.

D.4. Leveraging Existing Data Sources

The use of various data sources to verify the eligibility and accuracy of provider information is described in the table in Section D.1.5. These data sources include MMIS, Department of Health Licensure Database, and the CMS R&A system, and various uploaded documents from the attesting provider.

D.5. Sampling Methodology

This topic is addressed in a separately submitted audit strategy that is approved by CMS.

D.6. Reducing Provider Burden

Being part of the MAPIR collaborative and having the MAPIR system in place for the past six years, we have significantly reduced provider burden during the application process. Here is how:

- MAPIR and MMIS connectivity – Providers cannot participate in the program if they are not in the Medicaid MIS system as an active Medicaid Provider. Furthermore, and when it is necessary, MAPIR validates MMIS information during the application entry process.
- MAPIR Status Control – With MAPIR the SRA has the ability to change the status of an application prior to payment. So if there is an entry error, the application can be re-opened and the applicant can make the necessary modifications and re-submit their application.
- Electronic Payments made through the MMIS – Once the application is approved for payment in MAPIR, MAPIR will send a payment file request to CMS for approval. Once an approval is approved MAPIR will send a file to the MMIS to make an electronic EHR Incentive payment on the provider's remittance advice.
- Audits Tracked in MAPIR – The audit staff is utilizing the audit functions available within MAPIR. This function reduces redundancies in the audit process that may pose an additional burden to the provider. It also helps us avoid asking questions that are already in the MAPIR system. This capability improves our desk audit function.

We have also reduced provider burden by allowing our state's REC to assist providers who are struggling to meet meaningful use and assist the provider community with workflow changes. The regional managers from the REC would also encourage our providers to apply for the EHR Incentive and help them with their submission. Their efforts have greatly reduced provider burden and over time, providers were able to consistently meet meaningful use.

D.7. Program Integrity Operations

Rhode Island has a separate Office of Program Integrity (OPI) which ensures compliance, efficiency, and accountability within the health and human services programs administered by the State of Rhode Island by detecting and preventing fraud, waste, and program abuse and ensuring that state and federal dollars are spent appropriately, responsibly, and in accordance with applicable laws.

The Office of Program Integrity is also committed to identifying fraud, waste and abuse in Medicaid and in all health and human service programs. The OPI actively pursues any leads indicating fraudulent practices and uses them as a source to begin investigations. To increase our effectiveness, the OPI is partnering with Medicare and Medicaid insurance companies to share information about fraudulent activity and to conduct joint investigations. Their oversight of the Rhode Island Medicaid EHR Incentive program plays a significant role and has dedicated staff to audit the program and ensure payments made are within the regulations of the program. Below is a hierarchical staff diagram that shows a separation between operational and audit oversight that is strictly enforced. While we share information with rule changes and system updates, the operational staff does not partake in the audit functions.

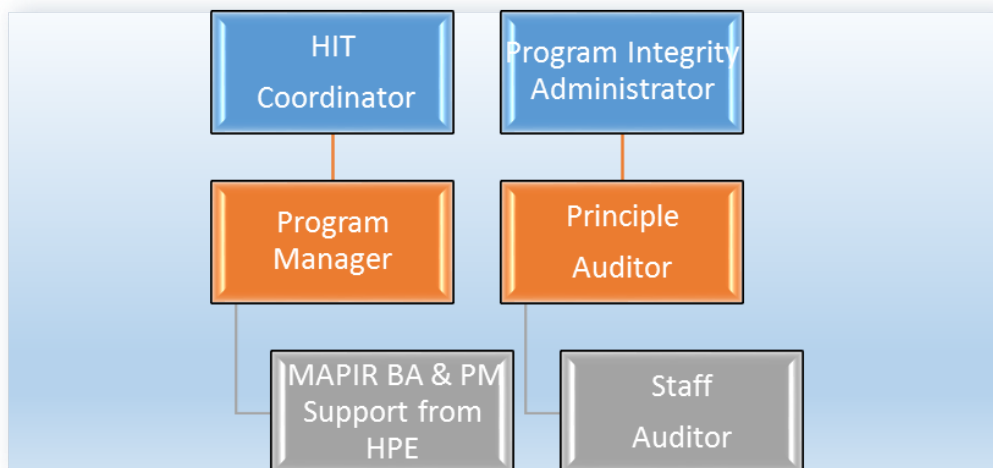

The roles of organizational staff are described below:

Administrator – Office of Program Integrity – Ensures program oversight and is responsible for the EHR program audit staff performance. In early 2013, the Rhode Island Executive Office of Health and Humans Services (EOHHS) formed the Office of Program Integrity similar to an internal audit team that provides regulatory oversight and prevents fraud and abuse within all Medicaid programs.

Principle Auditor – This position oversees the EHR Incentive audit functions, conducts higher risk EHR incentive program audits and reviews audits performed by the staff

auditor. The Principal Auditor is also responsible for developing and maintaining the RI Medicaid EHR Incentive Program Audit Strategy. Currently this position is serving as the only auditor for the program since the staff auditor position is vacant.

Staff Auditor – this position assists by performing EHR Incentive audits for all providers who are participating in the program. This position evaluates applications based on a defined risk assessment as defined within the CMS approved EHR Incentive Program’s Audit Strategy. In most cases, the auditor performs desk audits, but will perform onsite audits when required. This position is currently vacant.

State Health IT Coordinator –Responsible for overall management of the RI Medicaid EHR Incentive Program Oversees except for the audit functions. Works collaboratively with the auditors and program integrity administratively to coordinate overall program efforts, communicate programs changes or challenges, and review program progress.

EHR Incentive Program Manager – Oversees the daily operations of the RI Medicaid EHR Incentive Program. This position ensures that providers are meeting the CMS guidelines set forth in the final rule, oversees program outreach, policy development and implementation, and payment review and approval. This position works closely with the principal auditor when questions arise, to assure proper documentation is uploaded and to discuss any questions related to prepayment audit processes. This position is a Xerox employee.

HPE MAPIR Business Analyst – provides technical support for the MAPIR system and is a Hewlett Packard Enterprise employee. This position troubleshoots front end or backend EHR Incentive application issues within our MAPIR system. The business analyst is involved with testing and upgrading MAPIR to meet program regulatory requirements. In addition, this position requires ongoing collaboration with the MAPIR Collaborative. This positions works with the principal auditor to assure the proper functioning of the audit racking system within MAPIR.

HPE MAPIR Project Manager – provides administrative oversight for any large system implementation and upgrades to MAPIR and is a Hewlett Packard Enterprise employee. The MAPIR Project Manager is also responsible with requesting project task approval from the Health IT Coordinator when projects arise for the program. Works with the audit team as needed to assure proper functioning of MAPIR as it relates to audit functions

E. Medicaid HIT Roadmap

E.1. Where we are today and where we expect to be in Five Years

As described in section A in more detail, Rhode Island has invested considerable resources into establishing HIT systems to support a variety of business needs for state government and for community stakeholders. The diagram below shows a snapshot of many of these systems as of the end of 2016. Communication pathways are typically unidirectional and from one system to another. Consumers interact either directly or indirectly through staff at agencies and organizations with these systems.

As we look toward 2021 and our ideal state, there are several strategic projects that are yet to be fully defined. Additional information about these high priority projects will help solidify RI's approach to the expansion and integration of RI's overall HIT environment. Once the following information is available, a longer term strategy and ideal state will become clearer:

- Who will be the vendor for the eCQM Reporting and Feedback System and how will they interface with the state's HIT ecosystem
- What are the components of the EOHHS State Data Ecosystem that needs to be developed in order to fully serve the state's policy and operational needs, versus what components already exist and can leveraged or modified to meet the intended goal
- Whether legal and or regulatory changes can be made to remove some of the barriers to health information exchange that the state faces today, and to promote the ability to link claims and clinical data for operational and analytic uses

The future state will continue to evolve over time as these questions are answered. EOHHS 's focus will remain on increasing statewide interoperability both within and external to state government, improving the services and utility of existing HIT systems, and improving the collective ability of Rhode Islanders of all type to use data to improve the quality of care.

Despite the unknowns outlined above, EOHHS is prepared to and has begun to invest in achieving additional HIT infrastructure for 2021 as diagrammed below.

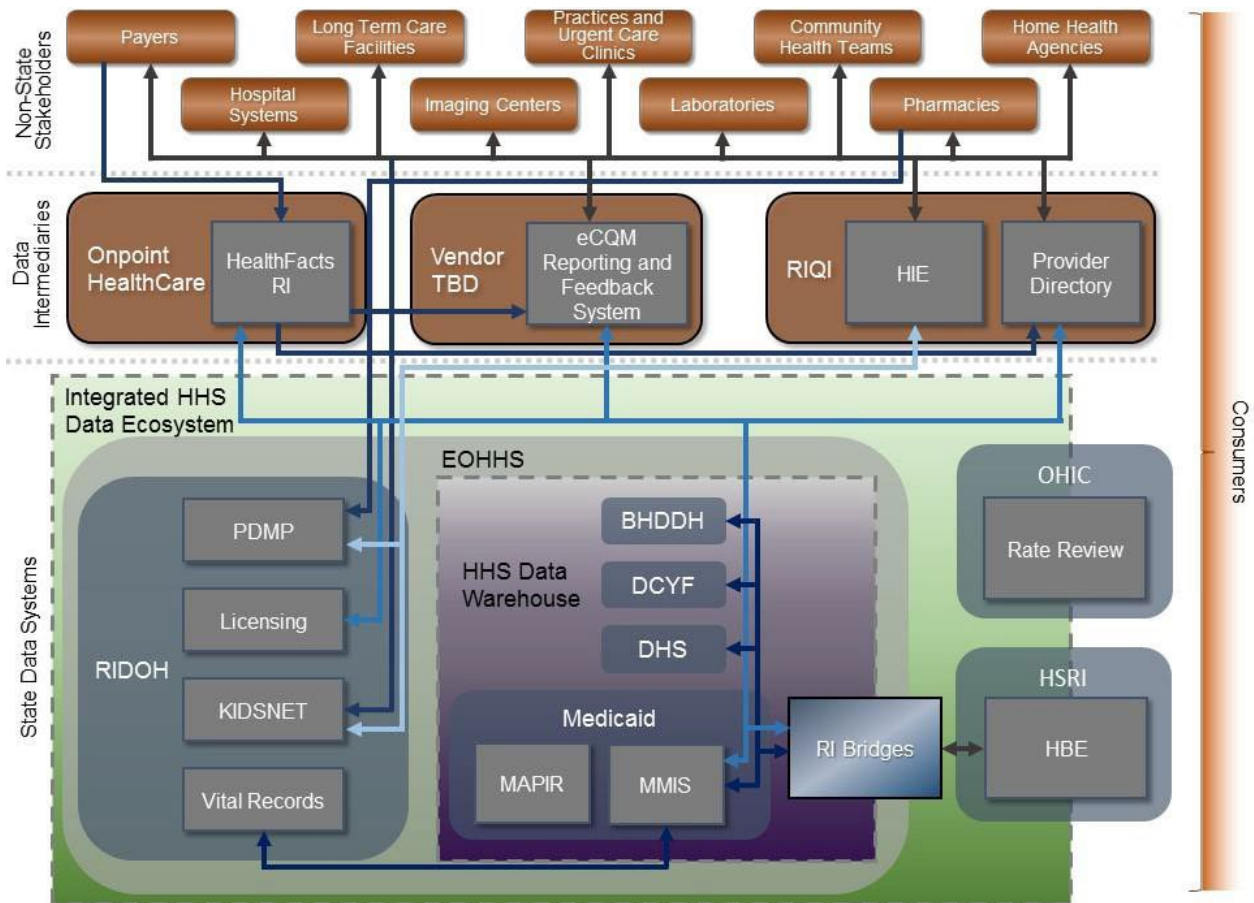

The “Future state” schematic above clearly identifies several components and features that are planned but not yet developed and or integrated into the overall picture. These include:

- Establishing an Integrated HHS Data Ecosystem.
- Establishing The eCQM Reporting and Feedback System
- Connecting HealthFacts RI and possibly CurrentCare to the eCQM Reporting and Feedback System.
- Having the HIE connected to the PDMP at RIDOH
- Having the statewide common Provider Directory supplying data to HealthFacts RI, the eCQM Reporting and Feedback System, MMIS, RI Bridges, HSRI and RIDOH Licensure.

E.2. Expectations for EHR technology and HIE Adoption Over Time with Annual Benchmarks

GOAL 1: 90% of hospitals, primary care providers, and outpatient specialists adopting CEHRT by 2021.

Annual Benchmarks:

Baseline	2017	2018	2019	2020	2021
59%	65%	75%	80%	85%	90%

GOAL 2: Achieve a 75% meaningful use conversion rate among RI Medicaid Eligible Providers (from AIU to MU) by 2021.

Annual Benchmarks:

Baseline	2017	2018	2019	2020	2021
55%	60%	65%	68%	70%	75%

GOAL 3A: 90% of Rhode Islanders having a CurrentCare Record by 2021

Annual Benchmarks:

Baseline	2017	2018	2019	2020	2021
46%	54%	62%	71%	80%	90%

GOAL 3B: 90% of all Medicaid beneficiaries having a CurrentCare Record by 2021

Annual Benchmarks:

Baseline	2017	2018	2019	2020	2021
38%	50%	62.5%	75%	77.5%	80%

GOAL 4: Increase awareness and use of CurrentCare, with 75% of physicians knowing of and using CurrentCare by 2021

Annual Benchmarks:

Baseline	2017	2018	2019	2020	2021
30%	39%	48%	57%	66%	75%

GOAL 5: Increase Interoperability among the state's HIT services where appropriate.

Annual Benchmarks:

Year	Benchmark
2017	Prescription Drug Monitoring Program (PDMP) integration with the HIE.
2018	Kidsnet Immunization Registry integration with the HIE.
2019	One additional integration, TBD.
2020	One additional integration, TBD.
2021	One additional integration, TBD.

E.3. Benchmarks for Audit and Oversight Activities

GOAL: Each year, complete pre-payment application review for all RI Medicaid EHR Incentive applications.

Annual Benchmarks:

Baseline	2017	2018	2019	2020	2021
100%	100%	100%	100%	100%	100%

GOAL: Each year, we plan to complete post payment application audits for 10-12% of the RI Medicaid EHR Incentive applications. As the program sunsets in 2021 and most providers have completed their six years of attestations, we expect a decrease of audits especially for program years 2020 and 2021.

Annual Benchmarks:

Baseline	2017	2018	2019	2020	2021
12%	10-12%	10-12%	10%	8-10%	6-8%

ATTACHMENT AA: SUD Monitoring Protocol
Reserved

**Attachment BB
Behavioral Link
Component Services**

Service	Service Description	Practitioner	Practitioner Qualifications	Limitations
Crisis Intervention/Assessment Services	Refers to short term emergency mental health services that are available on a twenty-four-hour basis, seven days a week. Behavioral health emergency, crisis intervention, and crisis stabilization services are immediate and short-term behavioral healthcare interventions provided to individuals experiencing an emergency or crisis situation. These services continue until the crisis is stabilized or the individual is safely transferred or referred for appropriate stabilization and/or ongoing treatment.	Qualified Mental Health Professional	BHDDH Rules and Regulation further defines “Qualified Mental Health Professional” (QMHP) as an individual with a minimum of a Master’s Degree in a clinical practice or a license as a Registered Nurse and have a minimum of thirty (30) hours of supervised face-to-face emergency services contact experience as a psychiatric emergency service worker in Rhode Island.	None
Nursing	Office or other outpatient visit for the evaluation and management of established patient	RN	Licensed Registered Nurse in the state of Rhode Island	None

Psychiatric diagnostic evaluation with medication services	Psychiatrist/Nurse Practitioner conducting a psychiatric evaluation and prescribing medication in accordance with that individuals needs/diagnosis.	MD or Advanced Nurse Practitioner	MD or APRN Licensed in the state of Rhode Island	None
Community Psychiatric Supported Treatment (CPST)	Community Psychiatric Supported Treatment (CPST) is provided to community-based clients and collaterals by professional mental health staff in accordance with an approved treatment plan for the purpose of insuring the client’s stability and continued community tenure by monitoring and providing medically necessary interventions to assist them in managing the symptoms of their illness and dealing with their overall life situation, including accessing needed medical, social, educational and other services necessary to meeting basic human needs.	Staff providing CPST shall, at a minimum, be a Registered Nurse or have an Associate's Degree in a human service field.	Licensed Registered Nurse in the state of Rhode Island or have an Associate's Degree in a human service field.	None
Peer Recovery Services	The Peer Recovery Specialist’s role as a behavioral and physical healthcare professional is to provide interventions that promote socialization, long-term recovery, wellness, self-advocacy, development of	Certified Peer Recovery Specialist (CPRS)	To be a Certified Peer Recovery Specialist (CPRS) an individual must be credentialed by the Rhode Island Board for Certification of Chemical Dependency Professionals (RIBCCDP) as a Peer Recovery Specialist.	None

	<p>natural supports, prevent relapse, and connectedness to one's community. The Peer Recovery Specialist does not replace any other behavioral or physical health professionals; it complements the existing array of support services.</p>		<p>RIBCCDP credentialing standards meet minimum standards of the International Certification and Reciprocity Consortium (IC&RC).</p> <p>RIBCCDP standards for Peer Recovery Specialist are:</p> <ul style="list-style-type: none"> • Education: High school diploma or equivalency. • Training: 46 hours of training with 10 hours each in the domains of Advocacy, Mentoring and Education, and Recovery/Wellness Support and 16 hours in the domain of Ethical Responsibility.²⁵ • Experience: 500 hours of volunteer or paid work experience specific to the domains. • Supervision: A total of 25 hours of supervision specific to the domains. Supervision must be provided by an 	
--	---	--	---	--

			<p>organization's documented and qualified supervisory staff per job description.</p> <ul style="list-style-type: none">• Examination: Applicants must pass the RIBCCDP Peer Recovery Examination.• Code of Ethics: The applicant must agree, in writing, to abide by the code of ethics.• Recertification: 20 hours of continuing education earned every 2 years including 6 hours in ethics.	
--	--	--	--	--

Attachment CC: Behavioral Link Payment Methodology

Introduction

BH Link is a specific set of services offered to individuals that are in crisis due to a substance use disorder and/or a mental health condition. These specific services are paid under one bundled rate, to support recovery-oriented environments dedicated to stabilizing individuals and linking them to the appropriate level of substance use disorder and/or mental healthcare treatment and/or recovery services within a less-intensive and less-costly setting of care than is furnished in a hospital setting. Accordingly, Rhode Island Medicaid established the protocols herein to define the claimable BH Link expenditures.

BH Link Program Bundled Rate

Only those providers that meet the criteria set forth in STC 104 may be reimbursed for BH Link services. A provider may not receive separate reimbursement for a BH Link service for the same individual for which a BH Link bundled rate was claimed. Medicaid providers delivering other Medicaid-covered services outside of the BH Link service bundle may bill in accordance with the state's Medicaid billing procedures. When providing services to individuals with mental health and/or substance use disorders, it may be necessary to provide the service multiple times before treatment is sought or is successful. Therefore, this bundle may be billed once daily per Medicaid beneficiary with no restriction on the number of times per month, so long as it does not exceed once per day. The following provides a description of how the rate methodology was developed. The methodology reflects an average number of units per day, recognizing that some stays will encompass a higher number of units and some stays will encompass a lower number of units. A stay is defined as an intake and discharge from the triage center. It can last no longer than 23 hours.

The BH Link bundled rate that was established by EOHHS is based on the rates paid to providers to deliver similar services on a fee-for-service basis. Rates from the current community mental health centers for case management, and the assessment, nursing monitoring and psychiatric services were utilized to inform the development of this rate. As explained in the chart below, the bundled rate is the sum of each product that resulted from multiplying each component rate by an anticipated average number of units for a BH Link participant. When submitting a claim for the BH Link bundled rate, providers must include service-level detail to document how many units of each service was delivered to an individual. The claim will be paid at the header level, and shadow billed component services will not receive separate reimbursement and be paid at zero. For a provider to receive the total reimbursement of \$598.50, they must perform a crisis assessment. The crisis assessment triggers the payment. Typically, the assessment will be followed with case management and monitoring services or psychiatric interventions such as an evaluation or the prescribing of medication. The BH Link bundled rate will be reviewed at least annually for economy and efficiency and recalculated by EOHHS as necessary. Any rate changes to the BH Link services must be reviewed and approved by CMS to verify reasonableness, efficiency and effectiveness. The BH Link rate does not include costs related to room and board or any other unallowable facility cost, or non-covered Medicaid services.

BH Link Triage Center Rate Composition					
Service	Rate/Unit	Duration of unit	Projected Average Number of Units	Projected Average Total time	Cost
Crisis assessment	\$150.00	60 minutes	1	60 minutes	\$150.00
Nursing/monitoring	\$7.50	5 minutes	24 units	120 minutes	\$180.00
Case Management	\$21.25	15 minutes	7 units	105 minutes	\$150.50
Psychiatrist (Evaluation and management)	\$118	25 minutes	1	25 minutes	\$118.00
Total					\$598.50